

EDCON-COMPONENTS

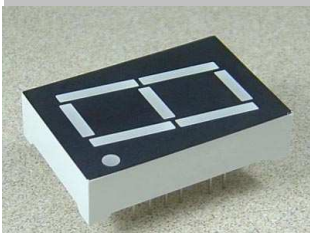

The Power of LED Light



Dimensions / Informations Model No. 1

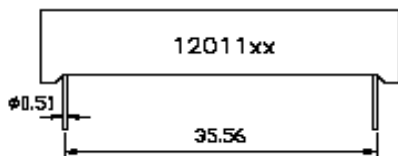
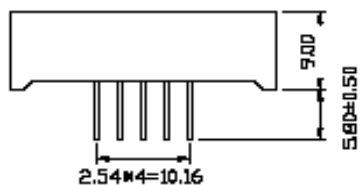
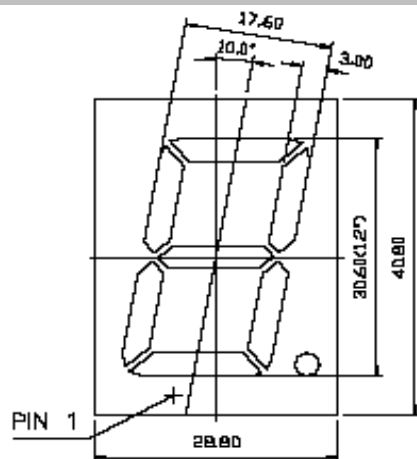
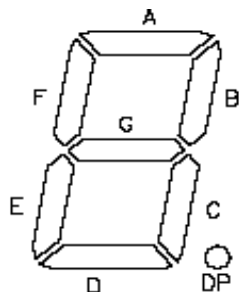

Package Dimensions & Internal Circuit Diagramm

Diode Drive Code A

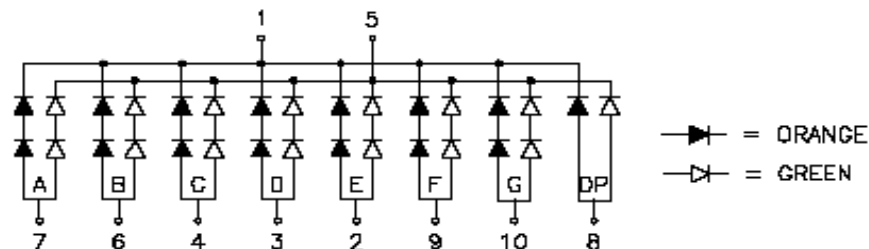

= ORANGE
 = GREEN

Diode Drive Code B

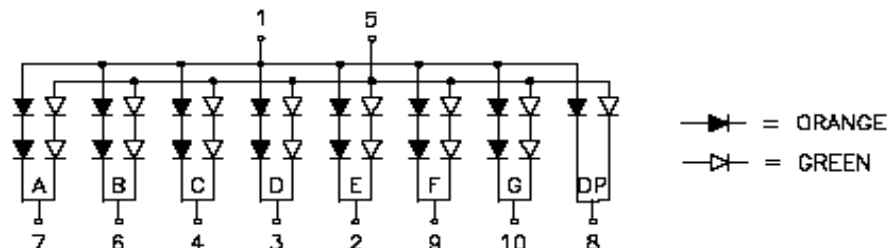

= ORANGE
 = GREEN

Features

- Low Current Operation
- Excellent Character appearance
- Easy mounting on P.C. Board or Sockets
- Standard Brightness / Ultra Brightness

All Dimensions are in millimeters (inches).
Tolerance is +/- 0,25 (0,01") unless otherwise specified.
Specifications are subject to change without notice.

**Segment Display Digit
Height 30,60mm**

Part No.: **M21A1078**

DRW:	Jason	CHKD	Wilson	MATL:	Wilson	TOLERANCE	Mason	DATE	30.09.2010
APPD:	Schumi			FINISH	Jamy		Sheet No.		1 from 6

Customer:

EDCON-COMPONENTS

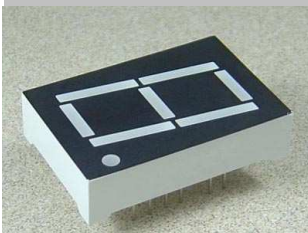

The Power of LED Light



Description

Emitting Order Code (nm)	Emitting Color	Dice Material	Peak Wave Length	Spectral Line Width	Forward Voltage (VF)		Luminous Intensity (Iv) Unit: mcd
					Unit:V	Unit:V	
700A	Red	GaP	700nm	90nm	2,20	2,50	5,0
660A	Hi Red	AlGaAs, (A)	660nm	20nm	1,80	2,20	15~20
660B	Super Red	AlGaAs, (B)	660nm	20nm	1,80	2,20	20~30
660C	Ultra Red	AlGaAs, (C)	660nm	20nm	1,90	2,40	26~38
640A	High Efficiency Red	GaAsP	640nm	45nm	1,90	2,40	50~80
630A	Orange	GaAsP	630nm	35nm	2,10	2,50	10~20
610A	Amber	GaAsP	610nm	35nm	2,10	2,50	15~20
590A	Yellow	GaAsP	590nm	35nm	2,10	2,50	15~20
570A	Green	GaP	570nm	30nm	2,10	2,50	14~18
645U	Ultra Hi Red	AlGaInP	645nm	20nm	2,10	2,50	80~50
630U	Ultra Orange	AlGaInP	630nm	20nm	2,10	2,50	180~120
610U	Ultra Amber	AlGaInP	610nm	20nm	2,10	2,50	90~120
590U	Ultra Yellow	AlGaInP	590nm	20nm	2,10	2,50	150~200
570U	Ultra Green	AlGaInP	570nm	30nm	2,20	2,50	60~100
520U	Ultra Pure Green	InGaN	520nm	36nm	2,80	3,80	260~310
505U	Ultra Blue Green	InGaN	505nm	36nm	2,80	3,80	260~310
430U	Blue	InGaN	430nm	30nm	2,80	3,80	10~20
470U	Ultra Blue Green	InGaN	470nm	30nm	2,80	3,80	80~90
405U	UViolett	InGaN	405nm		2,80	3,80	5~8
2930	White	InGaN	X=0,29 / Y=0,30		2,80	3,80	180~200
2931	Ultra White	InGaN	X=0,29 / Y=0,30		2,80	3,80	180~200

Color Code & Chip Characteristics: Test conditions: IF=20mA

**Segment Display Digit
Height 30,60mm**

Part No.: **M21A1078**

DRW:	Jason	CHKD	Wilson	MATL:	Wilson	TOLERANCE	Mason	DATE	30.09.2010
APPD:	Schumi			FINISH	Jamy		Sheet No.		2 from 6

Customer:

EDCON-COMPONENTS

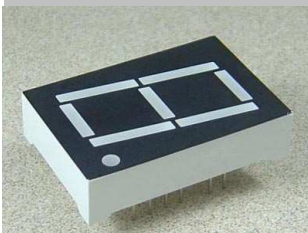

The Power of LED Light



Characteristics

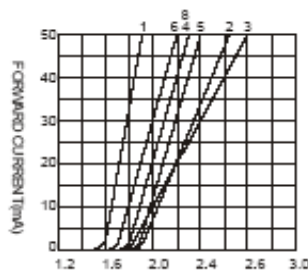

FORWARD VOLTAGE (V)
FORWARD CURRENT VS.
FORWARD VOLTAGE

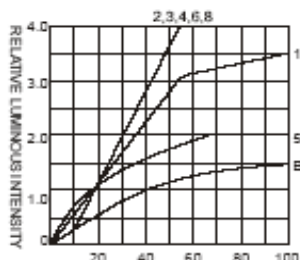

FORWARD CURRENT (mA)
RELATIVE LUMINOUS
INTENSITY VS. FORWARD
CURRENT

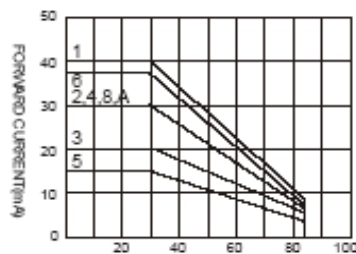

AMBIENT TEMPERATURE T_a (°C)
FORWARD CURRENT VS. AMBIENT
TEMPERATURE

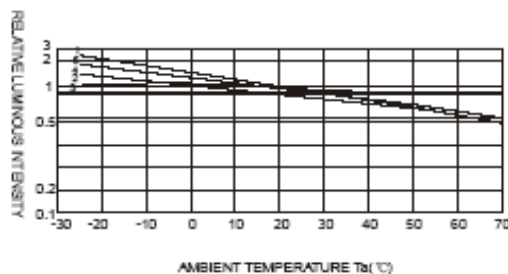
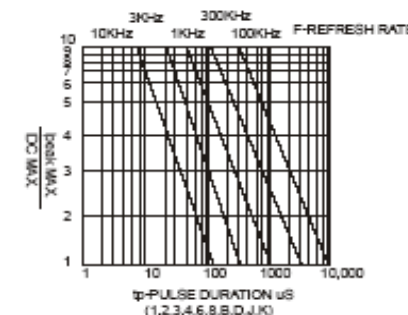
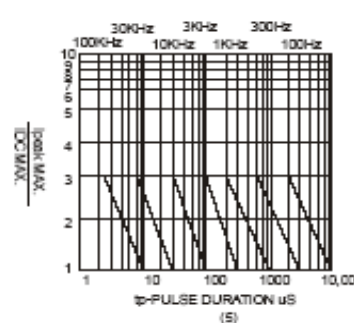

Note: 25°C free air temperature unless otherwise specified

**Segment Display Digit
Height 30,60mm**

Part No.: **M21A1078**

DRW:	Jason	CHKD	Wilson	MATL:	Wilson	TOLERANCE	Mason	DATE	30.09.2010
APPD:	Schumi			FINISH	Jamy		Sheet No.	3 from 6	Customer:

www.edcon-components.com

email: info@edcon-components.com

EDCON-COMPONENTS

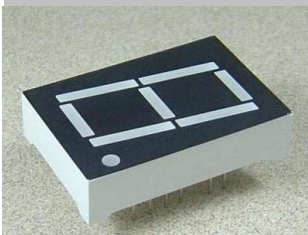

The Power of LED Light



Characteristics

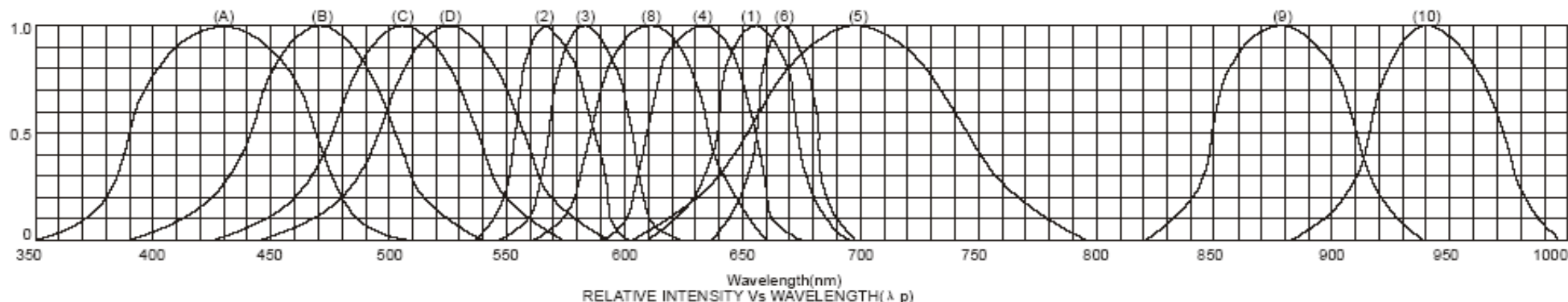

- | | |
|---|----------------------------------|
| 1 GaAsPI/GaAs 655nm Red | 9 GaAlAs 880nm |
| 2 GaP 570nm / Yellow Green | 10 GaAs/GaAs & GaAlAs/GaAs 940nm |
| 3 GaAsP/GaP 585nm / Yellow | A GaN/SiC 430nm Blue |
| 4 GaAsP/GaP 635nm / Orange & Hi Eff Red | B InGaN/SiC 470nm Blue |
| 5 GaP 700nm Bright /Red | C InGaN/SiC 505nm Ultra Green |
| 6 GaAlAs/GaAs 660nm / Super Red | D InGaN/SiC 525nm Ultra Green |
| 8 GaAsPI/GaP 610nm / Super Red | |

Parameter	Symbol	Test Conditions	Value		Unit
			Min	Max	
Reverse Voltage	VR	IR=30μA	5	----	V
Forward Voltage	IF	----	----	30	mA
Power Dissipation	Pd	----	----	100	mW
Pulse Current	Ipeak	Duty= 0,1mS 1KHZ	----	150	mA
Operating Temperature	Topr	----	-40	+85	°C
Storage Temperature	Tstr	----	-40	+85	°C

Absolute maximum ratings (Ta=25°C)

**Segment Display Digit
Height 30,60mm**

Part No.: **M21A1078**

DRW:	Jason	CHKD	Wilson	MATL:	Wilson	TOLERANCE	Mason	DATE	30.09.2010	Customer:
APPD:	Schumi			FINISH	Jamy		Sheet No.	4 from 6		

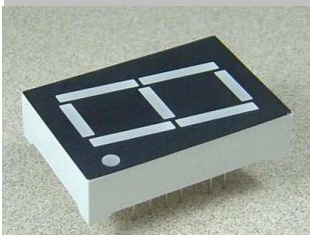

The Power of LED Light



Soldering Profile Curve

Classification Reflow Profile (JEDEC J-STD-020C)

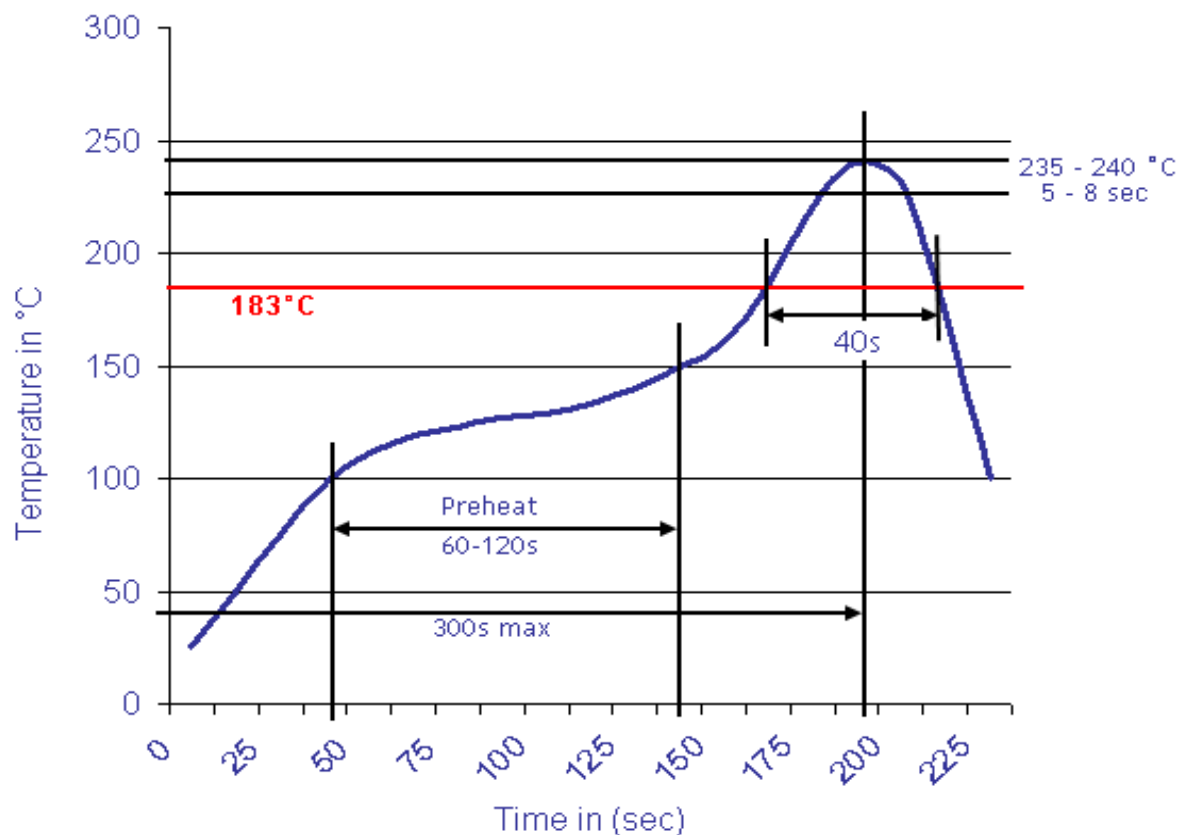

**Segment Display Digit
Height 30,60mm**

Part No.: **M21A1078**

DRW:	Jason	CHKD	Wilson	MATL:	Wilson	TOLERANCE	Mason	DATE	30.09.2010
APPD:	Schumi			FINISH	Jamy		Sheet No.	6 from 6	

Customer: