

EDCON-COMPONENTS

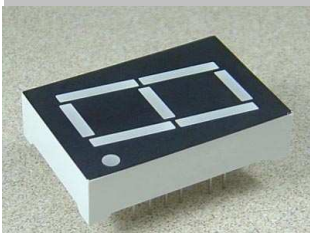

The Power of LED Light



Dimensions / Informations Model No. 3

Package Dimensions & Internal Circuit Diagramm

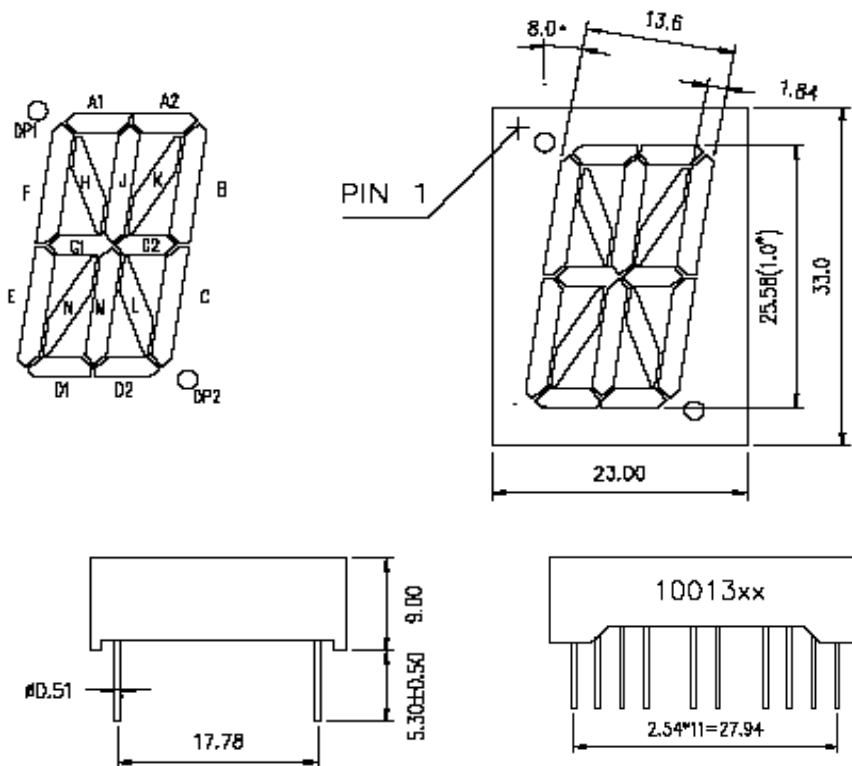

Diode Drive Code A

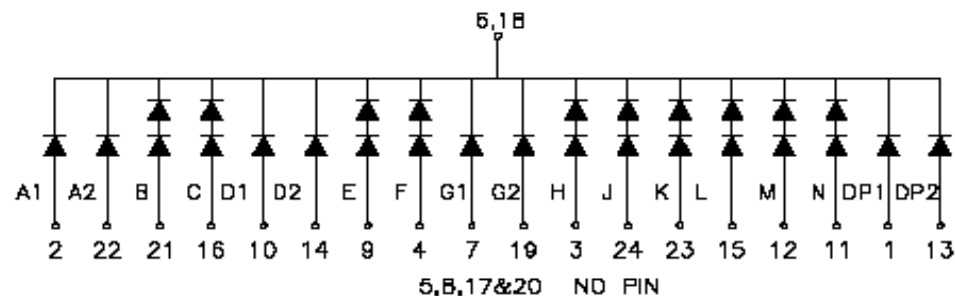

Diode Drive Code B

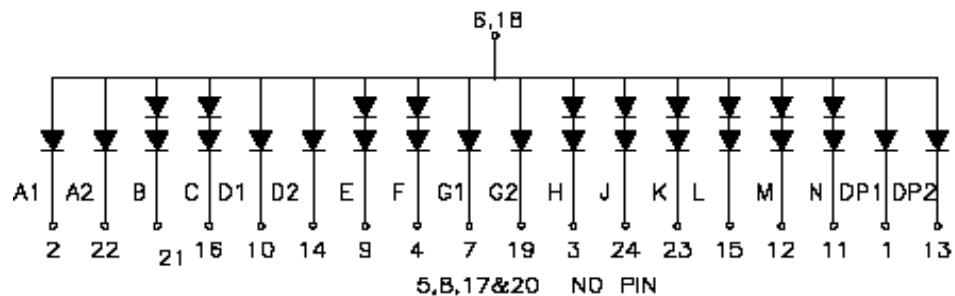

Features

- Low Current Operation
- Excellent Character appearance
- Easy mounting on P.C. Board or Sockets
- Standard Brightness / Ultra Brightness

All Dimensions are in millimeters (inches).
Tolerance is +/- 0,25 (0,01") unless otherwise specified.
Specifications are subject to change without notice.

**Segment Display Digit
Height 25,58mm**

Part No.: **M21A1073**

DRW:	Jason	CHKD	Wilson	MATL:	Wilson	TOLERANCE	Mason	DATE	30.09.2010	Customer:
APPD:	Schumi			FINISH	Jamy		Sheet No.	1 from 6		

www.edcon-components.com

email: info@edcon-components.com

EDCON-COMPONENTS

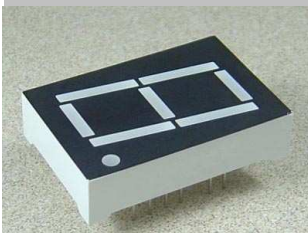

The Power of LED Light



Description

Emitting Order Code (nm)	Emitting Color	Dice Material	Peak Wave Length	Spectral Line Width	Forward Voltage (VF)		Luminous Intensity (Iv) Unit: mcd
					Unit:V	Unit:V	
700A	Red	GaP	700nm	90nm	2,20	2,50	5,0
660A	Hi Red	AlGaAs, (A)	660nm	20nm	1,80	2,20	15~20
660B	Super Red	AlGaAs, (B)	660nm	20nm	1,80	2,20	20~30
660C	Ultra Red	AlGaAs, (C)	660nm	20nm	1,90	2,40	26~38
640A	High Efficiency Red	GaAsP	640nm	45nm	1,90	2,40	50~80
630A	Orange	GaAsP	630nm	35nm	2,10	2,50	10~20
610A	Amber	GaAsP	610nm	35nm	2,10	2,50	15~20
590A	Yellow	GaAsP	590nm	35nm	2,10	2,50	15~20
570A	Green	GaP	570nm	30nm	2,10	2,50	14~18
645U	Ultra Hi Red	AlGaInP	645nm	20nm	2,10	2,50	80~50
630U	Ultra Orange	AlGaInP	630nm	20nm	2,10	2,50	180~120
610U	Ultra Amber	AlGaInP	610nm	20nm	2,10	2,50	90~120
590U	Ultra Yellow	AlGaInP	590nm	20nm	2,10	2,50	150~200
570U	Ultra Green	AlGaInP	570nm	30nm	2,20	2,50	60~100
520U	Ultra Pure Green	InGaN	520nm	36nm	2,80	3,80	260~310
505U	Ultra Blue Green	InGaN	505nm	36nm	2,80	3,80	260~310
430U	Blue	InGaN	430nm	30nm	2,80	3,80	10~20
470U	Ultra Blue Green	InGaN	470nm	30nm	2,80	3,80	80~90
405U	UViolett	InGaN	405nm		2,80	3,80	5~8
2930	White	InGaN	X=0,29 / Y=0,30		2,80	3,80	180~200
2931	Ultra White	InGaN	X=0,29 / Y=0,30		2,80	3,80	180~200

Color Code & Chip Characteristics: Test conditions: IF=20mA

**Segment Display Digit
Height 25,58mm**

Part No.: **M21A1073**

DRW:	Jason	CHKD	Wilson	MATL:	Wilson	TOLERANCE	Mason	DATE	30.09.2010
APPD:	Schumi			FINISH	Jamy		Sheet No.		2 from 6

Customer:

EDCON-COMPONENTS

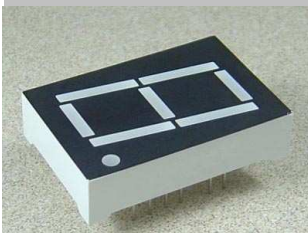

The Power of LED Light



Characteristics

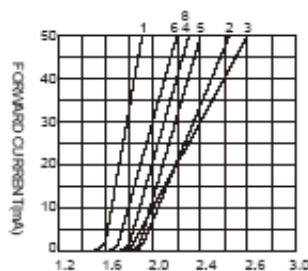

FORWARD VOLTAGE (V)
FORWARD CURRENT VS.
FORWARD VOLTAGE

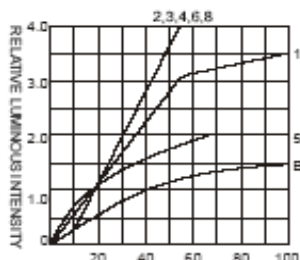

FORWARD CURRENT (mA)
RELATIVE LUMINOUS
INTENSITY VS. FORWARD
CURRENT

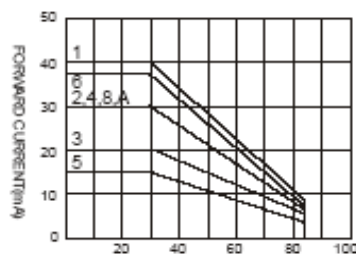

AMBIENT TEMPERATURE T_a (°C)
FORWARD CURRENT VS. AMBIENT
TEMPERATURE

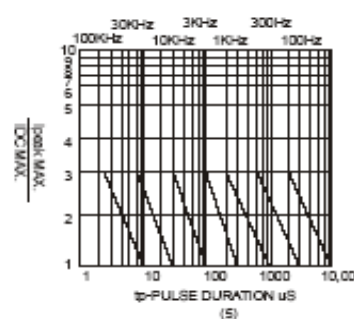

Note: 25°C free air temperature unless otherwise specified

**Segment Display Digit
Height 25,58mm**

Part No.: **M21A1073**

DRW:	Jason	CHKD	Wilson	MATL:	Wilson	TOLERANCE	Mason	DATE	30.09.2010
APPD:	Schumi			FINISH	Jamy		Sheet No.	3 from 6	Customer:

www.edcon-components.com

email: info@edcon-components.com

EDCON-COMPONENTS

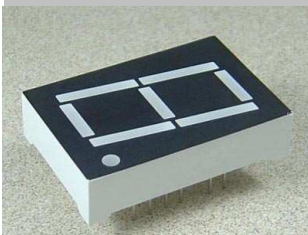

The Power of LED Light



Characteristics

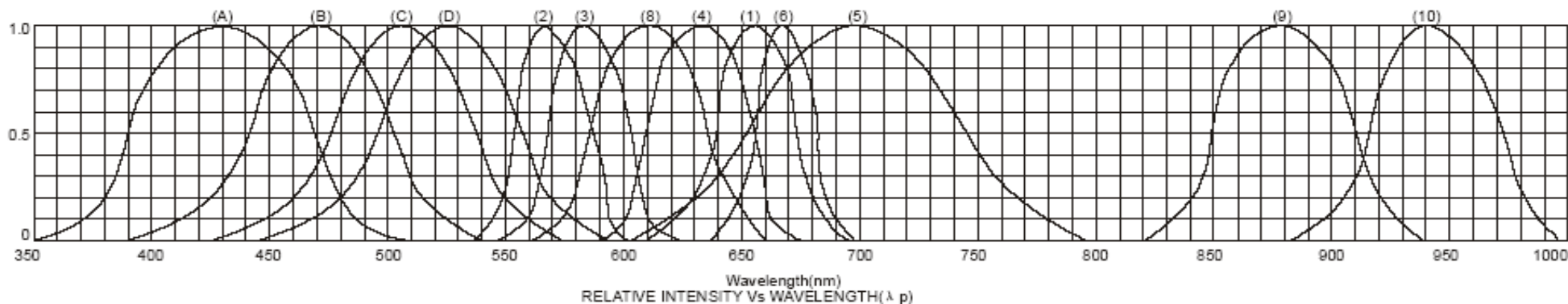

- | | |
|---|----------------------------------|
| 1 GaAsPI/GaAs 655nm Red | 9 GaAlAs 880nm |
| 2 GaP 570nm / Yellow Green | 10 GaAs/GaAs & GaAlAs/GaAs 940nm |
| 3 GaAsP/GaP 585nm / Yellow | A GaN/SiC 430nm Blue |
| 4 GaAsP/GaP 635nm / Orange & Hi Eff Red | B InGaN/SiC 470nm Blue |
| 5 GaP 700nm Bright /Red | C InGaN/SiC 505nm Ultra Green |
| 6 GaAlAs/GaAs 660nm / Super Red | D InGaN/SiC 525nm Ultra Green |
| 8 GaAsPI/GaP 610nm / Super Red | |

Parameter	Symbol	Test Conditions	Value		Unit
			Min	Max	
Reverse Voltage	VR	IR=30μA	5	----	V
Forward Voltage	IF	----	----	30	mA
Power Dissipation	Pd	----	----	100	mW
Pulse Current	Ipeak	Duty= 0,1mS 1KHZ	----	150	mA
Operating Temperature	Topr	----	-40	+85	°C
Storage Temperature	Tstr	----	-40	+85	°C

Absolute maximum ratings (Ta=25°C)

**Segment Display Digit
Height 25,58mm**

Part No.: **M21A1073**

DRW:	Jason	CHKD	Wilson	MATL:	Wilson	TOLERANCE	Mason	DATE	30.09.2010	Customer:
APPD:	Schumi			FINISH	Jamy		Sheet No.	4 from 6		

EDCON-COMPONENTS

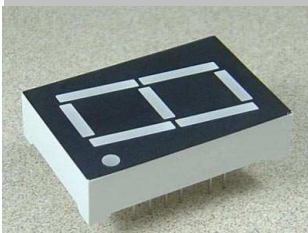

The Power of LED Light



Ordering Informations

Serie	Digit Height Code	Quantity of Digits	Model Number	Diode Drive Code	Emitting Color (nm)	Surface Color Code	Segment Color Code	Lead Length Code	ROHS	Package
-------	-------------------	--------------------	--------------	------------------	---------------------	--------------------	--------------------	------------------	------	---------

M21A1073	100	1	3	A	700A	2	1	62	R	Y
-----------------	------------	----------	----------	----------	-------------	----------	----------	-----------	----------	----------

100= 0,100" Digit Dimension	1= Single Digit	3= Model Number 3	A= Commun Cathode	Standard	Ultra Brightn	0= White Surface	0= Water Clear	62= Lead Length 6,2mm	R= ROHS conform	Y= Tray Packing (Standard)														
				700A= Red	645U= Hi Red						1= Black Surface	1= White Diffused	xx= Lead length Specified	N= NON ROHS conform	U= Tube Packing on Request									
				660A= Hi Red	630U= Ultra Orange											2= Gray Surface	2= Red Diffused							
				660B= Super Red	610U= Ultra Amber													3= Red Surface	3= Green Diffused					
				660C= Ultra Red	590U= Ultra Yellow															4= Green Surface	4= Yellow Diffused			
				B= Commun Anode	640A= HE Red																	520U= Ultra Pure Green	505U= Ultra Blue Green	
				630A= Orange	570U= Ultra Green																			470U= Ultra Blue
				610A= Amber	430U= Blue																			
				590A= Yellow	405U= Ultra Violett																			
				570A= Green	2930= White																			

Segment Display Digit Height 25,58mm
Part No.: M21A1073
Customer:

DRW:	Jason	CHKD	Wilson	MATL:	Wilson	TOLERANCE	Mason	DATE	30.09.2010
APPD:	Schumi			FINISH	Jamy		Sheet No.		5 from 6

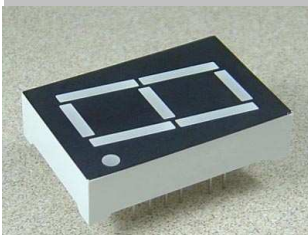

The Power of LED Light



Soldering Profile Curve

Classification Reflow Profile (JEDEC J-STD-020C)

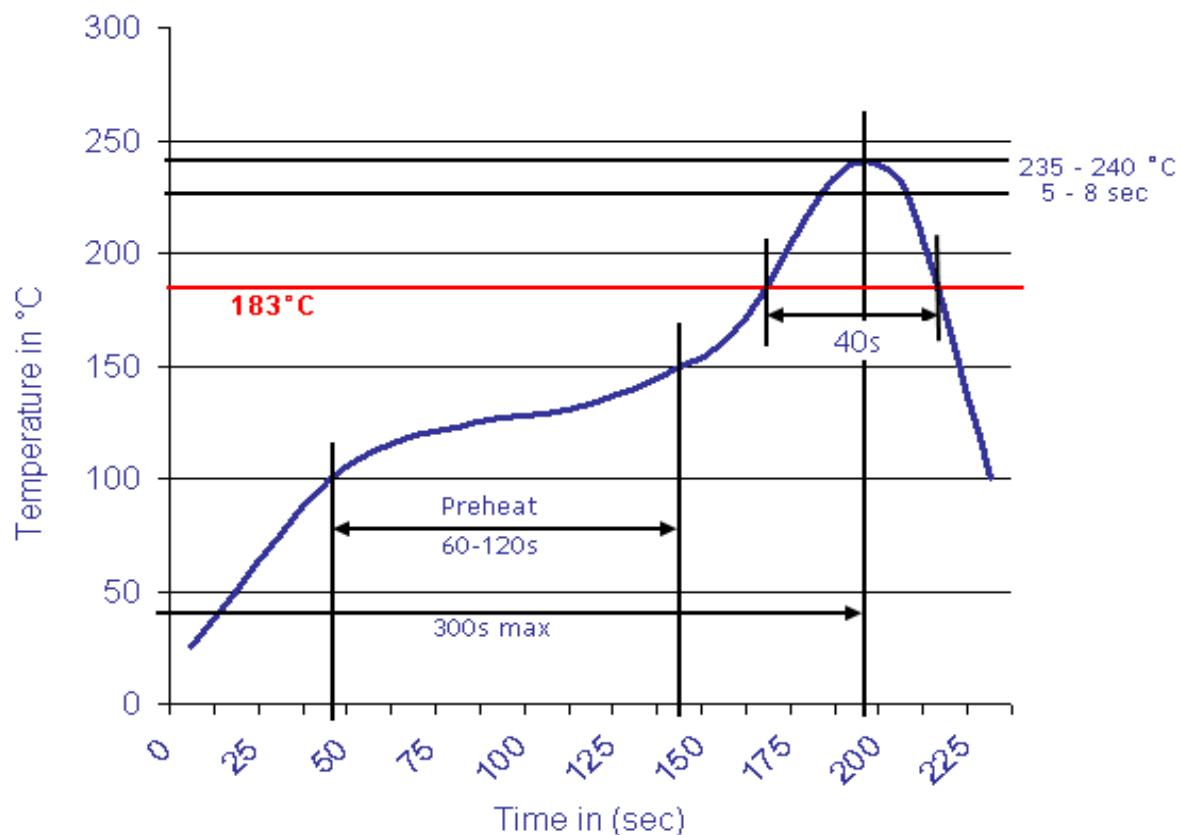

Segment Display Digit	
Height 25,58mm	
Part No.:	M21A1073
Customer:	

DRW:	Jason	CHKD	Wilson	MATL:	Wilson	TOLERANCE	Mason	DATE	30.09.2010
APPD:	Schumi			FINISH	Jamy		Sheet No.	6 from 6	