

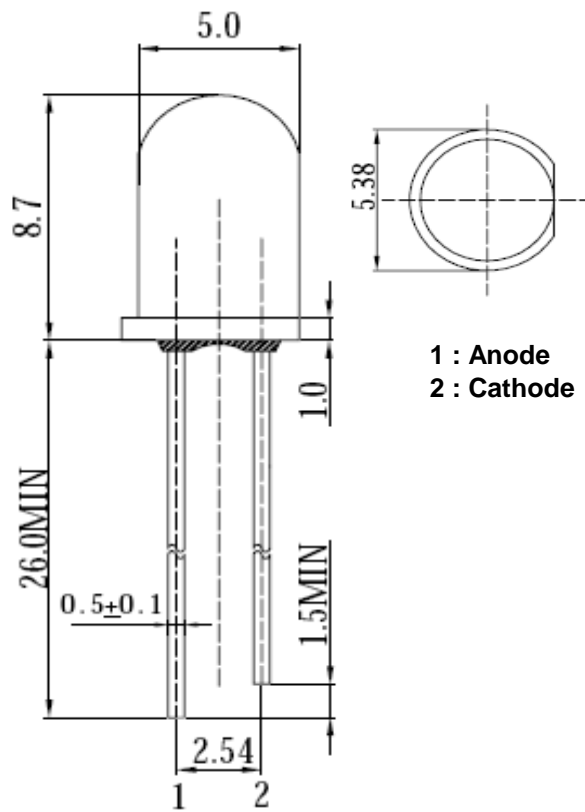

Applications

- Electronic Signs and Signals
- Small Area Illuminations
 - Back Lighting
 - Other Lighting

Technical Drawing



Notes :

All dimensions in mm tolerance is ± 0.1 mm unless otherwise noted.

Round Blinking LED Green	
Part No.:	M13J4006
Customer:	

DRW:	Dong	CHKD	Chang	MATL:	Chui	DATE	04.12.2009
APPD:	Ping			FINISH	Hui	Sheet	1 from 6



Absolute Maximum Ratings

Ta=25°C

Item	Symbol	AlGaInP	Unit
Power Dissipation	P _D	40	mW
DC Forward Current	I _F	20	mA
Pulsed Forward Current	I _{FP} *	100	mA
Reverse Voltage	V _R	5	V
Operating Temperature	T _{OP}	-30 to 80	°C
Storage Temperature	T _{ST}	-40 to 100	°C
Derating Linear From 50°C	---	0.4	mA / °C

* 0.1 msec pulse, 10% duty cycle

Electrical / Optical Characteristics

I_F=20mA Ta=25°C

Ermitting Color	Green		
Material	AlGaInP		
Forward Voltage	typ.	4.0	V _F
	max.	---	V _F
Wavelength typ.	λ _D	565	nm
	λ _P	570	nm
	Δλ	25	nm
Oscillator Frequency	min.	2.0	Hz
	typ.	2.4	Hz
	max.	2.8	Hz
Duty Cycle	typ.	---	---
Luminous Intensity *	min.	---	mcd
	typ.	---	mcd
Reverse Current	max.	50	μA
Viewing Angle	2Θ1/2	160	

* Per NIST standards

**Round Blinking LED
Green**

Part No.: **M13J4006**

Customer:

DRW:	Dong	CHKD	Chang	MATL:	Chui	DATE	04.12.2009
APPD:	Ping			FINISH	Hui	Sheet	2 from 6



Directive Characteristics

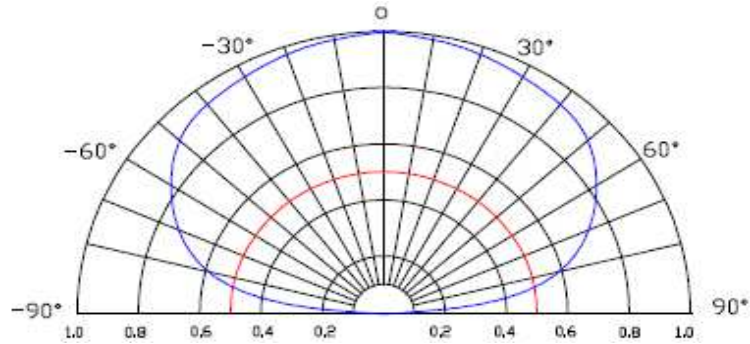

**Round Blinking LED
Green**

Part No.: **M13J4006**

Customer:

DRW:	Dong	CHKD	Chang	MATL:	Chui	DATE	04.12.2009
APPD:	Ping			FINISH	Hui	Sheet	3 from 6



Curve

Round Blinking LED Green	
Part No.:	M13J4006
Customer:	

DRW:	Dong	CHKD	Chang	MATL:	Chui	DATE	04.12.2009
APPD:	Ping			FINISH	Hui	Sheet	4 from 6



Solder Condition

Lead Free Solder



Round Blinking LED Green	
Part No.:	M13J4006
Customer:	

DRW:	Dong	CHKD	Chang	MATL:	Chui	DATE	04.12.2009
APPD:	Ping			FINISH	Hui	Sheet	5 from 6



Color table curve



Round Blinking LED Green	
Part No.:	M13J4006
Customer:	

DRW:	Dong	CHKD	Chang	MATL:	Chui	DATE	04.12.2009
APPD:	Ping			FINISH	Hui	Sheet	6 from 6

Copyright by EDCON-COMPONENTS