

Features:

- 14.20mm (0.56") Dual digit numeric display series.
- Standard brightness.
- Low current operation.
- Excellent character appearance.
- Easy mounting on P.C.boards or sockets.
- I.C.compatible.

Part No.:

Common Cathode	Iv TYP.(mcd)	Common Anode	Iv TYP.(mcd)
EYD-5622AH-XX	8	EYD-5622BH-XX	8
EYD-5622AS-XX	56	EYD-5622BS-XX	56
EYD-5622AD-XX	96	EYD-5622BD-XX	96
EYD-5622AUR-XX	112	EYD-5622BUR-XX	112
EYD-5622AE-XX	40	EYD-5622BE-XX	40
EYD-5622AY-XX	32	EYD-5622BY-XX	32
EYD-5622AG-XX	40	EYD-5622BG-XX	40

Description:

- Color Code & Chip characteristics: (Test Condition: IF=20mA)

Emitting Color		Dice Material	Peak Wave Length (λ _P)	Spectral Line halfwidth(λ _{1/2})	Forward Voltage(VF) Unit:V		Luminous Intensity (Iv) Unit:ucd
					Typ	Max	
H	Red	GaP/GaP	700nm	90nm	2.25	2.60	500
S	Hi Red	GaAlAs/GaAs,SH	660nm	20nm	1.85	2.20	3500
D	Super Red	GaAlAs/GaAs,DH	660nm	20nm	1.85	2.20	6000
UR	Ultra Red	GaAlAs/GaAs,DD H	660nm	20nm	1.85	2.20	7000
E	Orange	GaAsP/GaP	635nm	35nm	2.10	2.50	2500
Y	Yellow	GaAsP/GaP	585nm	35nm	2.10	2.50	2000
G	Green	GaP/GaP	570nm	30nm	2.20	2.50	2500

- -XX: Surface / Lens color :

Number	0	1	2	3	4	5
Ref Surface Color	White	Black	Gray	Red	Green	
Epoxy Color	Water clear	White diffused	Red Diffused	Green Diffused	Yellow Diffused	

Package configuration & Internal circuit diagram:

D-5622 Series

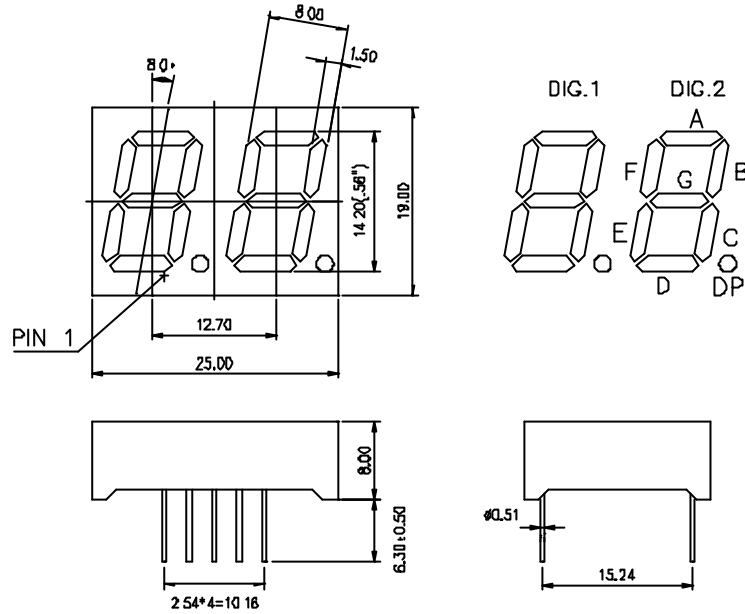

Ax

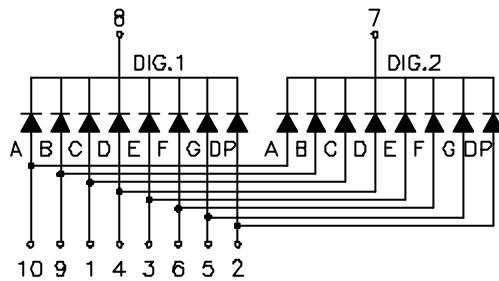

Bx

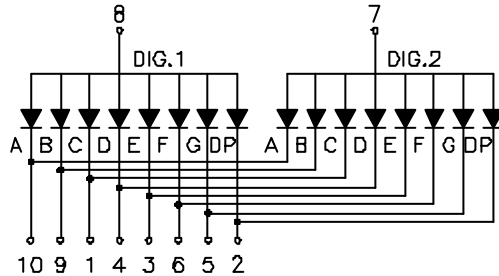

Notes:

- All dimensions are in millimeters (inches)
- Tolerance is $\pm 0.25(0.01)$ unless otherwise noted.
- Specifications are subject to change without notice.

Electrical-optical characteristics: (Ta=25)

Parameter	Symbol	GaP(Red)	AlGaAs	GaAsP	GaP(Green)	Unit
Power Dissipation	P_{ad}	40	60	80	80	mW
Peak Forward Current *	I_{pf}	50	150	150	150	mA
Continuous Forward Current	I_{af}	15	25	30	30	mA

Notes:

- * Test Condition = Duty 0.1,10KHZ

Absolute maximum ratings (Ta=25)

Reverse Voltage	5V
Reverse Current	20 μ A
Operating Temperature Range	-40 to+85
Storage Temperature Range	-40 to+85
Lead Solder Temperature (1.6mm(1/16")from body)	230 for 5 Seconds

Typical electrical-optical characteristics curves:

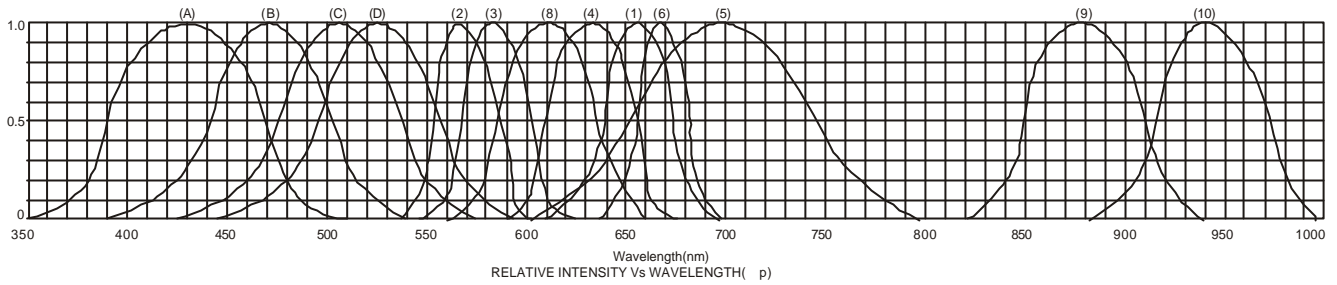

- (1) - GaAsP/GaAs 655nm/Red
- (2) - GaP 570nm/Yellow Green
- (3) - GaAsP/GaP 585nm/Yellow
- (4) - GaAsP/GaP 635nm/Orange & Hi-Eff Red
- (5) - GaP 700nm/Bright Red
- (6) - GaAlAs/GaAs 660nm/Super Red
- (8) - GaAsP/GaP 610nm/Super Red
- (9) - GaAlAs 880nm
- (10) - GaAs/GaAs & GaAlAs/GaAs 940nm
- (A) - GaN/SiC 430nm/Blue
- (B) - InGaN/SiC 470nm/Blue
- (C) - InGaN/SiC 505nm/Ultra Green
- (D) - InGaAl/SiC 525nm/Ultra Green

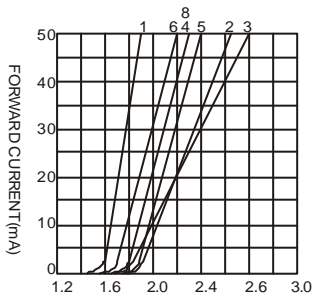

FORWARD VOLTAGE (Vf)
FORWARD CURRENT VS.
FORWARD VOLTAGE

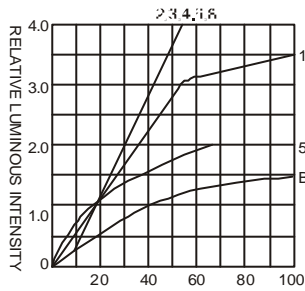

FORWARD CURRENT (mA)
RELATIVE LUMINOUS
INTENSITY VS. FORWARD
CURRENT

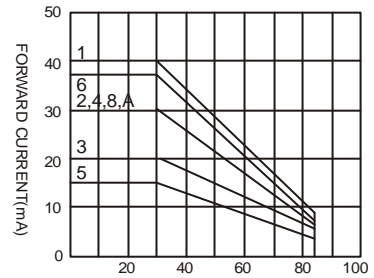

AMBIENT TEMPERATURE Ta(°C)
FORWARD CURRENT VS. AMBIENT
TEMPERATURE

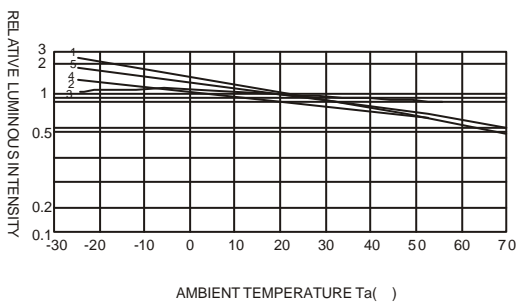

AMBIENT TEMPERATURE Ta(°C)

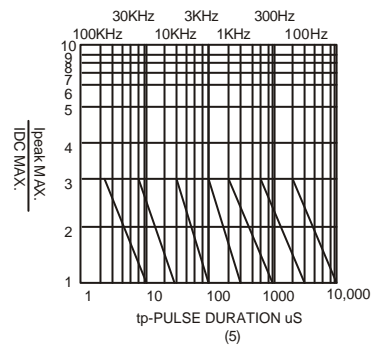
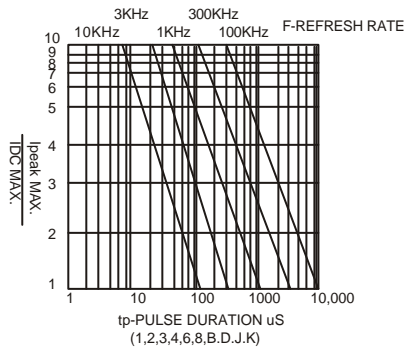

NOTE:25 free air temperature unless otherwise specified