

**Features:**

- 12.70mm (0.50") Dual digit numeric display series.
- Standard brightness.
- Low current operation.
- Excellent character appearance.
- Easy mounting on P.C.boards or sockets.
- I.C.compatible.

**Part No.:**

Common Cathode	Iv TYP.(mcd)	Common Anode	Iv TYP.(mcd)
EYD-5021EH-XX	8	EYD-5021FH-XX	8
EYD-5021ES-XX	56	EYD-5021FS-XX	56
EYD-5021ED-XX	96	EYD-5021FD-XX	96
EYD-5021EUR-XX	112	EYD-5021FUR-XX	112
EYD-5021EE-XX	40	EYD-5021FE-XX	40
EYD-5021EY-XX	32	EYD-5021FY-XX	32
EYD-5021EG-XX	40	EYD-5021FG-XX	40

**Description:**

- Color Code & Chip characteristics: (Test Condition: IF=20mA)

Emitting Color		Dice Material	Peak Wave Length (λ <sub>P</sub> )	Spectral Line halfwidth(λ <sub>1/2</sub> )	Forward Voltage(VF) Unit:V		Luminous Intensity (Iv) Unit:ucd
					Typ	Max	
H	Red	GaP/GaP	700nm	90nm	2.25	2.60	500
S	Hi Red	GaAlAs/GaAs,SH	660nm	20nm	1.85	2.20	3500
D	Super Red	GaAlAs/GaAs,DH	660nm	20nm	1.85	2.20	6000
UR	Ultra Red	GaAlAs/GaAs,DD H	660nm	20nm	1.85	2.20	7000
E	Orange	GaAsP/GaP	635nm	35nm	2.10	2.50	2500
Y	Yellow	GaAsP/GaP	585nm	35nm	2.10	2.50	2000
G	Green	GaP/GaP	570nm	30nm	2.20	2.50	2500

- -XX: Surface / Lens color :

Number	0	1	2	3	4	5
Ref Surface Color	White	Black	Gray	Red	Green	
Epoxy Color	Water clear	White diffused	Red Diffused	Green Diffused	Yellow Diffused	

Package configuration & Internal circuit diagram:

D-5021 Series

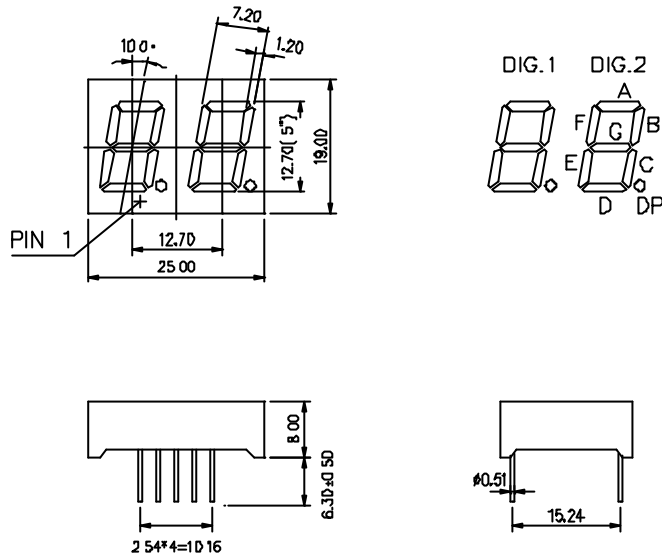

D-5021Ex

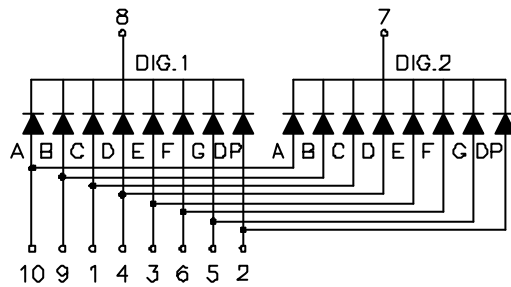

D-5021Fx

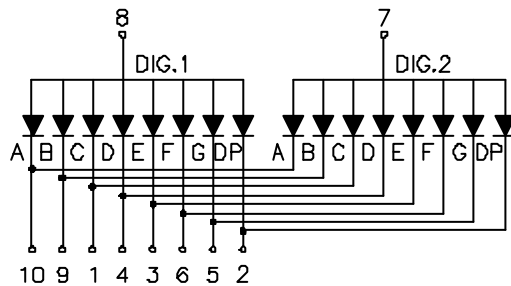

Notes:

- All dimensions are in millimeters (inches)
- Tolerance is  $\pm 0.25(0.01)$  unless otherwise noted.
- Specifications are subject to change without notice.

**Electrical-optical characteristics: (Ta=25 )**

Parameter	Symbol	GaP(Red)	AlGaAs	GaAsP	GaP(Green)	Unit
Power Dissipation	$P_{ad}$	40	60	80	80	mW
Peak Forward Current *	$I_{pf}$	50	150	150	150	mA
Continuous Forward Current	$I_{af}$	15	25	30	30	mA

Notes:

- \* Test Condition = Duty 0.1,10KHZ

**Absolute maximum ratings (Ta=25 )**

Reverse Voltage	5V
Reverse Current	20 $\mu$ A
Operating Temperature Range	-40 to+85
Storage Temperature Range	-40 to+85
Lead Solder Temperature (1.6mm(1/16")from body)	230 for 5 Seconds

**Typical electrical-optical characteristics curves:**

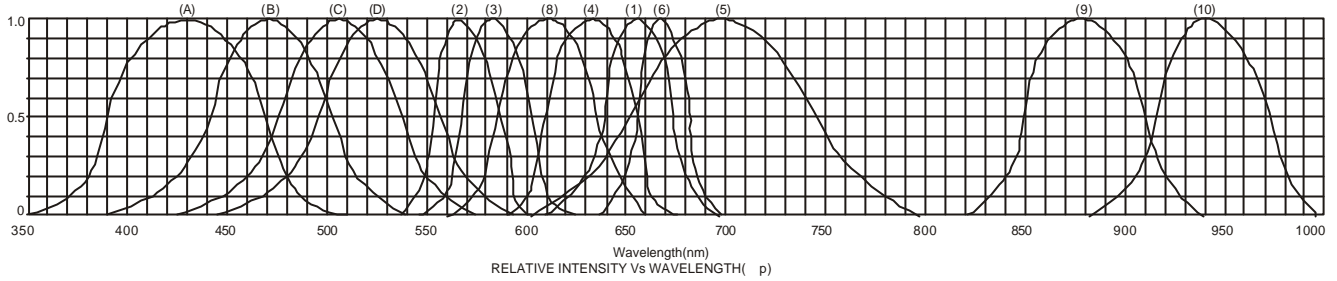

- (1) - GaAsP/GaAs 655nm/Red
- (2) - GaP 570nm/Yellow Green
- (3) - GaAsP/GaP 585nm/Yellow
- (4) - GaAsP/GaP 635nm/Orange & Hi-Eff Red
- (5) - GaP 700nm/Bright Red
- (6) - GaAlAs/GaAs 660nm/Super Red
- (8) - GaAsP/GaP 610nm/Super Red
- (9) - GaAlAs 880nm
- (10) - GaAs/GaAs & GaAlAs/GaAs 940nm
- (A) - GaN/SiC 430nm/Blue
- (B) - InGaN/SiC 470nm/Blue
- (C) - InGaN/SiC 505nm/Ultra Green
- (D) - InGaAl/SiC 525nm/Ultra Green

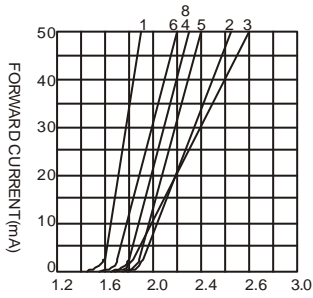

FORWARD VOLTAGE (Vf)  
FORWARD CURRENT VS.  
FORWARD VOLTAGE

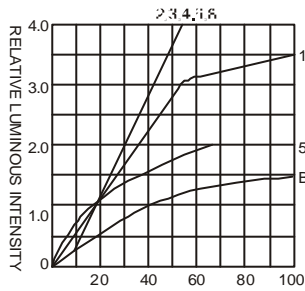

FORWARD CURRENT (mA)  
RELATIVE LUMINOUS  
INTENSITY VS. FORWARD  
CURRENT

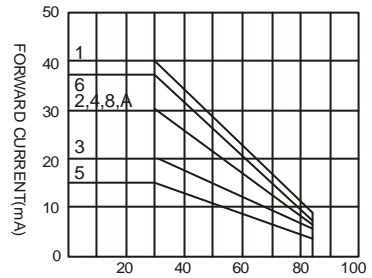

AMBIENT TEMPERATURE Ta( °C )  
FORWARD CURRENT VS. AMBIENT  
TEMPERATURE

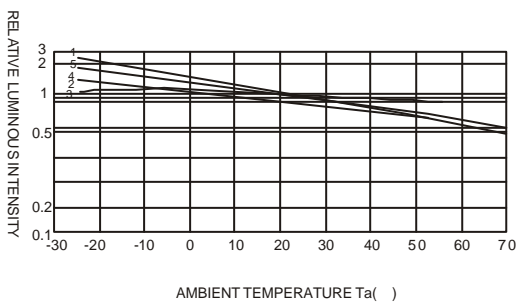

AMBIENT TEMPERATURE Ta( °C )

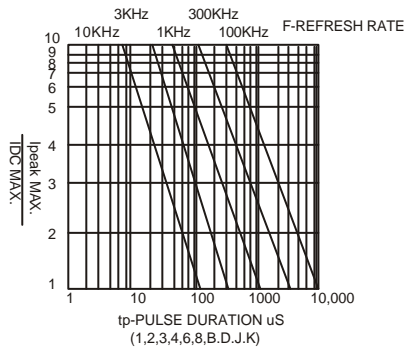

tp-PULSE DURATION  $\mu$ S  
(1,2,3,4,6,8,B,D,J,K)

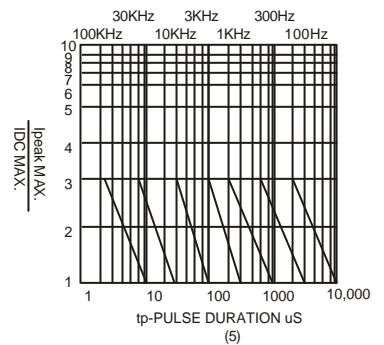

tp-PULSE DURATION  $\mu$ S  
(5)

NOTE:25 free air temperature unless otherwise specified