

Features:

- 10.2mm (0.40") Dual digit numeric display series.
- Ultra brightness.
- Low current operation.
- Excellent character appearance.
- Easy mounting on P.C.boards or sockets.
- I.C.compatible.

Part No.:

| Common Cathode | Iv TYP.(mcd) | Common Anode | Iv TYP.(mcd) |
|-----------------|--------------|-----------------|--------------|
| EYD-4021GUHR-XX | 112 | EYD-4021HUHR-XX | 112 |
| EYD-4021GUE-XX | 112 | EYD-4021HUE-XX | 112 |
| EYD-4021GYO-XX | 112 | EYD-4021HYO-XX | 112 |
| EYD-4021GUY-XX | 112 | EYD-4021HUY-XX | 112 |
| EYD-4021GUG-XX | 80 | EYD-4021HUG-XX | 80 |
| EYD-4021GPG-XX | 80 | EYD-4021HPG-XX | 80 |
| EYD-4021GB-XX | 80 | EYD-4021HB-XX | 80 |
| EYD-4021GW-XX | 80 | EYD-4021HW-XX | 80 |

Description:

- Color Code & Chip characteristics: (Test Condition: IF=20mA)

| Emitting Color | | Dice Material | Peak Wave Length(I_P) (nm) | Spectral Line halfwidth($I_{1/2}$) | Forward Voltage(VF) Unit:V | | Luminous Intensity (Iv) Unit:ucd |
|----------------|------------------|---------------|--------------------------------|--------------------------------------|----------------------------|------|----------------------------------|
| | | | | | Typ | Max | |
| UH | Ultra Hi Red | AlGaInP | 645nm | 20nm | 2.10 | 2.50 | 7000 |
| R | | | | | | | |
| UE | Ultra Orange | AlGaInP | 630nm | 20nm | 2.10 | 2.50 | 7000 |
| YO | Ultra Amber | AlGaInP | 610nm | 20nm | 2.10 | 2.50 | 7000 |
| UY | Ultra Yellow | AlGaInP | 590nm | 20nm | 2.10 | 2.50 | 7000 |
| UG | Ultra Green | AlGaInP | 574nm | 30nm | 2.20 | 2.50 | 5000 |
| PG | Ultra Pure Green | AlGaInP | 525nm | 36nm | 3.80 | 4.50 | 5000 |
| B | Blue | InGaN | 430nm | 30nm | 3.80 | 4.50 | 5000 |
| W | White | InGaN | - | - | 3.80 | 4.50 | 5000 |

- -XX: Surface / Lens color :

| Number | 0 | 1 | 2 | 3 | 4 | 5 |
|-------------------|-------------|----------------|--------------|----------------|-----------------|---|
| Ref Surface Color | White | Black | Gray | Red | Green | |
| Epoxy Color | Water clear | White diffused | Red Diffused | Green Diffused | Yellow Diffused | |

Package configuration & Internal circuit diagram:

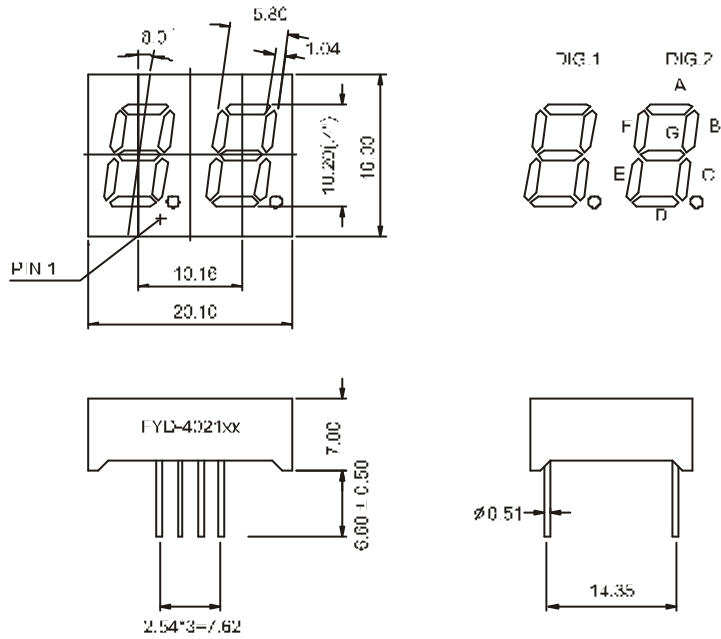

9

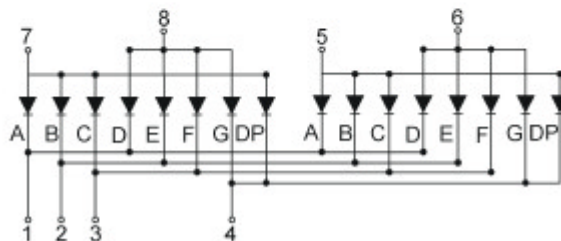
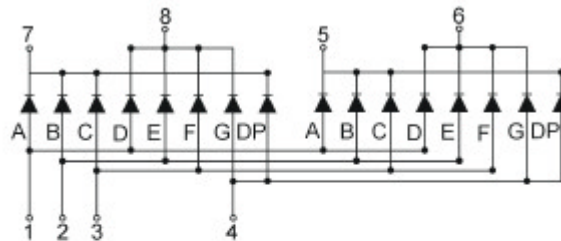

Notes:

- All dimensions are in millimeters (inches)
- Tolerance is $\pm 0.25(0.01)$ unless otherwise noted.
- Specifications are subject to change without notice.

Electrical-optical characteristics: (Ta=25)

| Parameter | Symbol | AlGaInP | InGaN | Unit |
|----------------------------|----------|---------|-------|------|
| Power Dissipation | P_{ad} | 75 | 120 | mW |
| Peak Forward Current * | I_{pf} | 150 | 100 | mA |
| Continuous Forward Current | I_{af} | 30 | 30 | mA |

Notes:

- * Test Condition = Duty 0.1,10KHZ

Absolute maximum ratings (Ta=25)

| | |
|---|-------------------|
| Reverse Voltage | 5V |
| Reverse Current | 20 μ A |
| Operating Temperature Range | -40 to+85 |
| Storage Temperature Range | -40 to+85 |
| Lead Solder Temperature (1.6mm(1/16")from body) | 230 for 5 Seconds |

Typical electrical-optical characteristics curves:



- (1) - GaAsP/GaAs 655nm/Red
- (2) - GaP 570nm/Yellow Green
- (3) - GaAsP/GaP 585nm/Yellow
- (4) - GaAsP/GaP 635nm/Orange & Hi-Eff Red
- (5) - GaP 700nm/Bright Red
- (6) - GaAlAs/GaAs 660nm/Super Red
- (8) - GaAsP/GaP 610nm/Super Red
- (9) - GaAlAs 880nm
- (10) - GaAs/GaAs & GaAlAs/GaAs 940nm
- (A) - GaN/SiC 430nm/Blue
- (B) - InGaN/SiC 470nm/Blue
- (C) - InGaN/SiC 505nm/Ultra Green
- (D) - InGaAl/SiC 525nm/Ultra Green

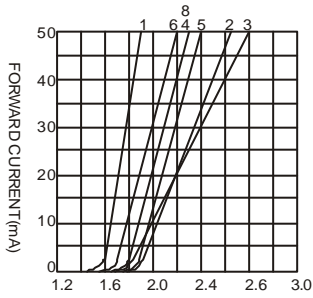

FORWARD VOLTAGE (Vf)
FORWARD CURRENT VS.
FORWARD VOLTAGE

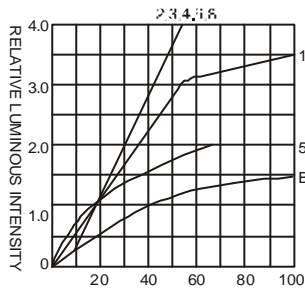

FORWARD CURRENT (mA)
RELATIVE LUMINOUS
INTENSITY VS. FORWARD
CURRENT

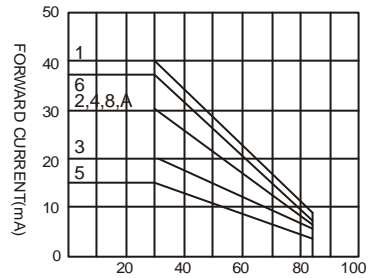

AMBIENT TEMPERATURE Ta(°C)
FORWARD CURRENT VS. AMBIENT
TEMPERATURE

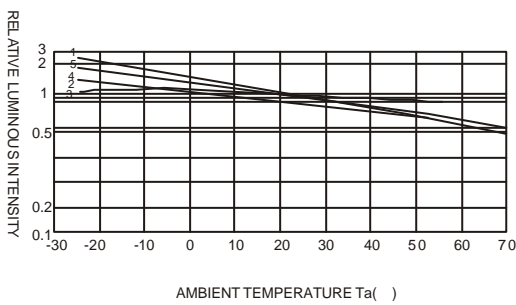

AMBIENT TEMPERATURE Ta(°C)

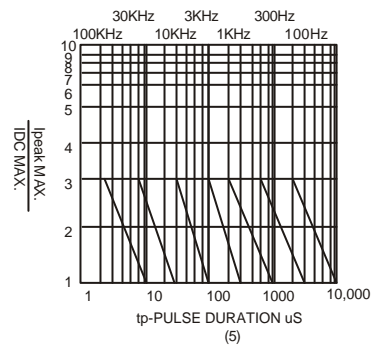
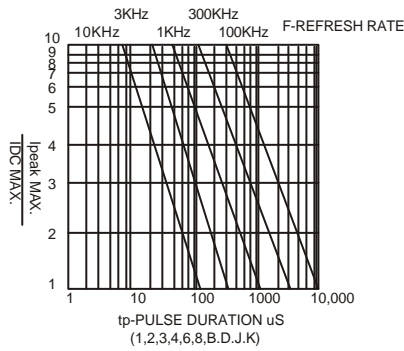

NOTE:25 free air temperature unless otherwise specified