



DATA SHEET

Super High Voltage Disc Ceramic Capacitor

Serie: I23002

Range 222= 2200pf

Tolerance K= $\pm 10\%$

Voltage 6000 Volt

Material Character. 5P

Body Diam. 16,0mm

Pitch 10mm

Body Thickn. 7,0mm

**Super High Voltage Disc
Ceramic Capacitor**

Serie No.: **I23002**

DRW:	Jason	CHKD	Wilson	MATL:	Wilson	TOLERANCE	Mason	DATE	30.04.2011	Customer:
APPD:	Schumi			FINISH	Jamy		Sheet No.	1 from 14		

EDCON-COMPONENTS



Features

- Wide rated Voltage range, wide nominal capacitance range
- Flame retardent, insulating coating applied
- Recommended Application
- Filter circuit of high voltage power
- High voltage circuit of television set and monitor
- High voltage circuit of various electronic equipment

Characteristics	Temp.Char. SL	Temp.Char. Y5P	Temp.Char. Y5U	Temp.Char. Y5V		
Operating Temperature	-30°C ~ +85°C					
Rated Voltage	4KVDC ~ 6KVDC	4KVDC ~ 15KVDC	4KVDC ~ 15KVDC	4KVDC ~ 15KVDC		
Withstanding Voltage	1,5 times related voltage					
Capacitance	Within the specified tolerance, testing at 25°C, 1Vrms and 1KHz (at 1MHz for SL products)					
	10 ~ 330pf	100 ~ 2200pf	470 ~ 3300pf	1000 ~ 10000pf		
Dissipation Factor	Cr<30pf, Q≥ 400+20Cr Cr≥30pf, Q≥1000	tg ≤ 2,5%	tg ≤ 3,5%			
Insulation Resistance	Charge at 500VDC for 60 seconds, Rj ≥ 1000MΩ					
Temperature Characteristics	Temperatur Chararcteristics Code		SL	Y5P	Y5U	Y5V
	Temperatur Coefficient (10-6 /°C)		. +100 ~ - 1000 10-6/°C	. ± 10%	.+22 ~ +56%	.+22 ~ +82%

Rated Capacitance

The first and second digits identify the first and second significant figures of the capacitance, the third digit identifies the multiplier. The capacitance unit is pf,

Capacitance Tolerance

Letter Symbol	Capacitance Tolerance	Letter Symbol	Capacitance Tolerance
C	±0,25pf	K	±10%
D	±0,5pf	M	±20%
J	±5%	Z	.+80 ~ -20%

**Super High Voltage Disc
Ceramic Capacitor**

Part No.: **I23002**

DRW:	Jason	CHKD	Wilson	MATL:	Wilson	TOLERANCE	Mason	DATE	30.04.2011	Customer:
APPD:	Schumi			FINISH	Jamy		Sheet No.	2 from 14		

EDCON-COMPONENTS



Standard atmospheric condition
 Temperature: 15~35°C
 Relative Humidity: 45~75%
 Atmospheric pressure: 86~106KPa (860~1060mbar)
 Operating and storage temperature range
 Operating Temperature:

Temperature Characteristics	Lowest Operating Temperature	Highest Operating Temperature
SL	. -25°C	.+85°C
COH	. -25°C	.+85°C
Y5P	. -25°C	.+85°C
Y5U	. -25°C	.+85°C
Y5U	. -25°C	.+85°C
Y5V	. -25°C	.+85°C
Z5U	10°C	.+85°C
Z5V	10°C	.+85°C
YR	. -25°C	.+125°C

Storage Temperature Range: -10 to + 40°C

Characteristics and test methods

Electrical characteristics and test methods

Capacitance & tolerance	The Capacitance shall be measured at 25°C with 1Mhz and 1Vrms (Class1), 1KHz and 1Vrms (class II), 1KHz and 0,1Vrms (for Calss III)	Refer to individual sheet
Quality factor or dissipation factor	The quality factor or dissipation factor shall be measured at the same conditions ab above	Q _{≥400} +20Cr (forCr<30pf) Q _{≥1000} (forCr<30pf) Cr-rated capacitance in unit of pf 2,5% max. (for Y5P,Y5U and Z5U) 0,5% max. (for YR) 3,5% max. (for Y5V and Z5U) 5%max. (for SBBLC Y5V and Y5U) 3,5%max. (for SBBLC Y5P)
Insulation Resistance	The insulation resistance shall be measured with rated voltage (for Vr≤500VDC); 500VDC (for Vr≥500VDC)within 50± 5seconds of charging	1000M Ω min 1000M Ω min (for SBBLC)
Voltage Proof	The Voltage of 300% rated voltage (for rated voltage 540V and 500V) 200% rated voltage (for rated voltage 1000V to 2000V), 175% rated voltage (for rated voltage 3000V), or 150% rated Voltage (for DCG or SBBLC) shall be applied between leads for 1 to 5seconds. The voltages of 250% rated voltage (for 50V capacitors) or 1300V (fort 500V, 1KV and over) shall be applied between leads connected together and metal foil wrapped on envelope for 1 to 5 seconds.	No breakdown or flashover
		Super High Voltage Disc Ceramic Capacitor
		Part No.: I23002

DRW:	Jason	CHKD	Wilson	MATL:	Wilson	TOLERANCE	Mason	DATE	30.04.2011
APPD:	Schumi			FINISH	Jamy		Sheet No.		3 from 14

Customer:

EDCON-COMPONENTS



Temperature Characteristics	<p>The capacitor shall be kept for enough time to reach thermal equilibrium at special temperature of each step in the following table. The capacitance measurement shall be made only at the thermal equilibrium of each step.</p> <table style="width: 100%; border-collapse: collapse;"> <tr> <td style="text-align: center;">Step</td> <td style="text-align: center;">Temperature</td> <td style="text-align: center;">Step</td> <td style="text-align: center;">Temperature</td> </tr> <tr> <td style="text-align: center;">1</td> <td style="text-align: center;">20 ± 2°C</td> <td style="text-align: center;">4</td> <td style="text-align: center;">85 ± 2°C (125 ± 2°C for YR)</td> </tr> <tr> <td style="text-align: center;">2</td> <td style="text-align: center;">-25 ± 2°C</td> <td style="text-align: center;">5</td> <td style="text-align: center;">20 ± 2°C</td> </tr> <tr> <td style="text-align: center;">3</td> <td style="text-align: center;">20 ± 2°C</td> <td></td> <td></td> </tr> </table> <p>For temperature characteristics SL the steps 1 and step 2 may be omitted. The temperature coefficient and the capacitance drift shall be calculated by the following formulas.</p> $\text{Temperature Coefficient (ppm/°C)} = \frac{C_m - C_o}{C_o (T - T_o)} \times 10^6$ $= \frac{C_o - C_1}{C_o} \quad \text{or} \quad \frac{C_5 - C_o}{C_o} \quad \text{or} \quad \frac{C_5 - C_1}{C_o}$ <p>Where</p> <ul style="list-style-type: none"> Co Capacitance at step 3 Cm Capacitance at step 2 and/or step 4 C1,C5 Capacitance at step 1 and step 5 To Measuring temperature at Step 3 T Measuring temperature at Step 2 and /or step 4 <p>Pre-treatment: The capacitor shall be stored at a temperature of 55 ± 2°C and a relative humidity of 20% or less for 16 to 24 hours. And then the capacitor shall be allowed immediately to cool in container using appropriate dryer such as activated carbon, silica gel</p>	Step	Temperature	Step	Temperature	1	20 ± 2°C	4	85 ± 2°C (125 ± 2°C for YR)	2	-25 ± 2°C	5	20 ± 2°C	3	20 ± 2°C			<p>Class I Temperature coefficient: Refer to specification sheet Capacitance drift: Within ±1% or ± 0,05pf (Whichever is greater)</p> <p>Class II & III Temperature Characteristics Permitting capacitance change</p> <table style="width: 100%;"> <tr> <td>Y5P</td> <td style="text-align: center;">± 10%</td> </tr> <tr> <td>YR</td> <td style="text-align: center;">± 15% to -30%</td> </tr> <tr> <td>Y5U</td> <td style="text-align: center;">± 22% to -56%</td> </tr> <tr> <td>Z5U</td> <td style="text-align: center;">± 22% to -56%</td> </tr> <tr> <td>Y5V</td> <td style="text-align: center;">± 22% to -82%</td> </tr> <tr> <td>Z5V</td> <td style="text-align: center;">± 22% to -82%</td> </tr> </table>	Y5P	± 10%	YR	± 15% to -30%	Y5U	± 22% to -56%	Z5U	± 22% to -56%	Y5V	± 22% to -82%	Z5V	± 22% to -82%
Step	Temperature	Step	Temperature																											
1	20 ± 2°C	4	85 ± 2°C (125 ± 2°C for YR)																											
2	-25 ± 2°C	5	20 ± 2°C																											
3	20 ± 2°C																													
Y5P	± 10%																													
YR	± 15% to -30%																													
Y5U	± 22% to -56%																													
Z5U	± 22% to -56%																													
Y5V	± 22% to -82%																													
Z5V	± 22% to -82%																													
Robustness of Termination	<p>The capacitor body shall be held in such a manner so that axis of the lead is vertical. The tensile force of 10N (for Ø 0,6mm lead) or 5N (for Ø 0,5mm lead) shall be applied to the lead in a direction of ist axis and acting in a direction away from the body of the capacitor for 10 ± 1 seconds.</p>	<p>The capacitor shall be no broken and the lead shall be no loosened or cut off.</p>																												

Super High Voltage Disc Ceramic Capacitor

Part No.: **I23002**

DRW:	Jason	CHKD	Wilson	MATL:	Wilson	TOLERANCE	Mason	DATE	30.04.2011
APPD:	Schumi			FINISH	Jamy		Sheet No.		4 from 14

Customer:

EDCON-COMPONENTS



Bending	The capacitor is held in such a manner so that axis of the lead is vertical. As mass applying a force of 5N (for Ø 0,6mm lead) or 2,5N (for Ø 0,5mm lead) is then suspended from the end of the lead. The body of the capacitor is then inclined within a period of 2 to 3 seconds, through an angle of approximately 90° in the vertical plane and then returned to its initial position over the same period of time. This operation constitutes one bend. The lead shall be subjected to a total of 2 alternating bends in to opposite directions.	The lead shall be no broken.	
Endurance characteristics and test methods.			
Solderability	Solder temperature: 235 ±5°C Immersion time; 2 ± 0,5 seconds Immersion speed: 25 ± 6mm/s	A new uniform coating of solder shall cover a minimum of 95% of the surface being immersed.	
Vibration	Frequency range: 10~55Hz. Amplitudte (total excursion); 1,5mm Total duration: 6hours. This motion shall be aplyed for 2 hours in aech of three mutually perpendicular directions.	Apperance	No visible damage
		Capacitance change	Within specified tolerance
		Quality factor or dissipation factor	Refer to clause 5.1.2
Resistance to Soldering Heat	Solder temperature and immersion time: 260 ± 5°C, 10 ± 0,5 seconds. The immersing depth shall be a position 1,27mm from the seating plane. Post treatment: The capacitor shall be preversed at the standard atmospheric condition for 24 ± 2hours.	Apperance	No visible damage
		Capacitance change	± 2,5% or ± 0,25pf (whichever is greater, for class I). ± 5% (for Y5P and YR). ±15% (for Y5U and Z5U). ±20% (for Y5V and Z5V).
		Voltage Proof (for between leads only)	
Solvent resistance	The capacitor shall be immersed into isopropylalcohol. For 30 ± seconds.	Apperance	No visible damage legible marking

Super High Voltage Disc Ceramic Capacitor

Part No.: **I23002**

DRW:	Jason	CHKD	Wilson	MATL:	Wilson	TOLERANCE	Mason	DATE	30.04.2011	Customer:
APPD:	Schumi			FINISH	Jamy		Sheet No.	5 from 14		

EDCON-COMPONENTS



Temperature Cycle	The capacitor shall be placed in the test chamber at temperature of $-25 \pm 2^{\circ}\text{C}$ for 30minutes then at room temperature for 3 minutes at $85 \pm 2^{\circ}\text{C}$ ($125 \pm 2^{\circ}\text{C}$ for YR) for 30minutes and at room temperature for 3 minutes. This operation constitutes one cycle. The capacitor shall be subjected to a total of 5 cycle. Post-treatment: The capacitor shall be preversed at the standard atmospheric condition for 24 ± 2 hours.	Apperance	No visible damage Legible marking	
		Capacitance Change	$\pm 5\%$ or $\pm 0,5\text{pf}$ (whichever is the greater for class 1) $\pm 10\%$ (Y5P and YR) $\pm 20\%$ (Y5U and Z5U) $\pm 30\%$ (Y5V and Z5V)	
		Quality factor or dissipation factor	$Q \geq 200 + 10\text{Cr}$ (for Cr <10pf $Q \geq 275 + 5/2\text{Cr}$ (for $10\text{pf} \leq \text{CR} < 30\text{pf}$ $Q \geq 350$ (for Cr $\geq 30\text{pf}$) 5% max. (Y5V & Z5V) 3% max. (Y5P, YR, Y5U & Z5U) 7,5% max. (SBBLC)	
		Insulation Resistance	1000M Ω min. 500M Ω min. (SBBLC)	
		Voltage proof	For between leads only.	
Damp Heat	The capacitor shall be stored for 500^{+24} hours at a temperature of $40 \pm 2^{\circ}\text{C}$ and a relative humidity of 90 to 95%. Post treatment: The capacitor shall be preversed for 1 to 2 hours at the standard atmospheric condition.	Apperance	No visible damage	
		Capacitance Change	As the same	
		Q or DF	As the same	
		Insulation Resistance	2500M Ω min (Class I) 1000M Ω min (Class II) 500M Ω min (Class III)	
		Voltage proof	For between leads only.	
Endurance	The voltage that is equal to 200% rated voltage (for 50V and 500V capacitors), or 125% rated voltage (for 1KV~3KV capacitors), or 125% rated voltage for over 4KV or SBBLC) shall be applied continuously to the capacitor at temperature of $85 \pm 3^{\circ}\text{C}$ ($125 \pm 3^{\circ}\text{C}$ for YR) for 1000^{+48} hours.	Apperance	The same us before	
		Capacitance Change		
		Quality factor or dissipation factor		
		Insulation Resistance		
		Voltage proof		

Super High Voltage Disc Ceramic Capacitor

Part No.: **I23002**

DRW:	Jason	CHKD	Wilson	MATL:	Wilson	TOLERANCE	Mason	DATE	30.04.2011	Customer:
APPD:	Schumi			FINISH	Jamy		Sheet No.		6 from 14	

EDCON-COMPONENTS



Structure and ROHs Materail request

The marking of class I temperature characteristics is the color block on top of the capacitor

Temperature Characteristics	C0 Δ	SL
	Black	None

The marking of class II & III temperature characteristics is symbols specified in following table:

Temperature Characteristics	Y5P	Y5U / Z5U	Y5V / Z5V	YR
	Black	E	F	HRR&R

Capacitance

When rated capacitance is under 100pf the capacitance marking is value being rated capacitance in unit pf. When rated capacitance is 100pf or over the capacitance marking is made in third digit method.

Tolerance:

The tolerance marking for Class I is the symbols specified in following table.

Tolerance:	± 0,25pf	±0,5pf	±5%	±10%	±20%
Symbol	C	D	J	K	M

The tolerance marking for Class II & III is the symbols specified in following table.

Tolerance:	± 10%	± 20%	+.50%, -20%	+.100%, 0%	+.80%, -20%
Symbol	K	M	SL	P	Z

Rated Voltage

When rated voltage is 50V the voltage marking is symbol "___" under capcitanace marking.

When rated voltage is 500V the voltage marking is symbol "___" over capcitanace marking.

When rated voltage is 1000V or over, the voltage marking is symbols 1KV, 2KV, 3KV, 6KV..... over capacitance marking.

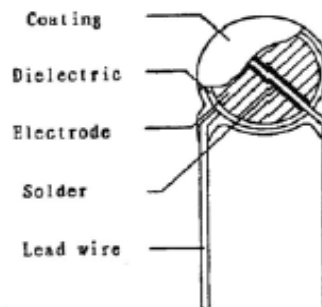

Coating :	Resin
Dielectric :	Ceramic
Electrode :	Silver
Solder :	Alloy Tin
Lead Wire :	Lead

Components	Material	ROHS request	Remark
Coating	Resin	Cd <100ppm;	Appendix 1; SGS report (Availbale as customer request or See Appendix 1
Dielectric	Ceramic	Pb <100ppm;	
Electrode	Silver	HG, Ctr PBBs, PBDEs, N,D	
Solder	Alloy tin		
Lead Wire	Lead		

Super High Voltage Disc Ceramic Capacitor

Part No.: **I23002**

DRW:	Jason	CHKD	Wilson	MATL:	Wilson	TOLERANCE	Mason	DATE	30.04.2011
APPD:	Schumi			FINISH	Jamy		Sheet No.		7 from 14

Customer:

EDCON-COMPONENTS



Example of marking (Class I)

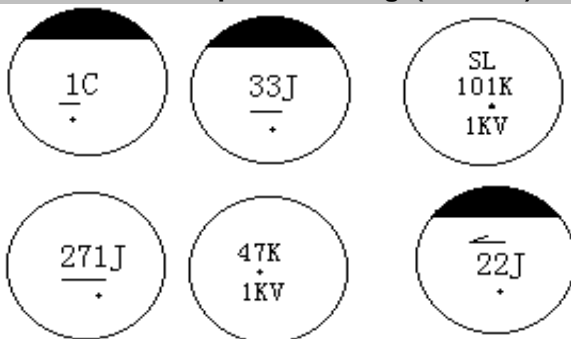

Example of marking (Class II & III) over 1000 Volt



Typical Characteristics Graph

II类温度特性曲线

Class II Temperature Characteristic

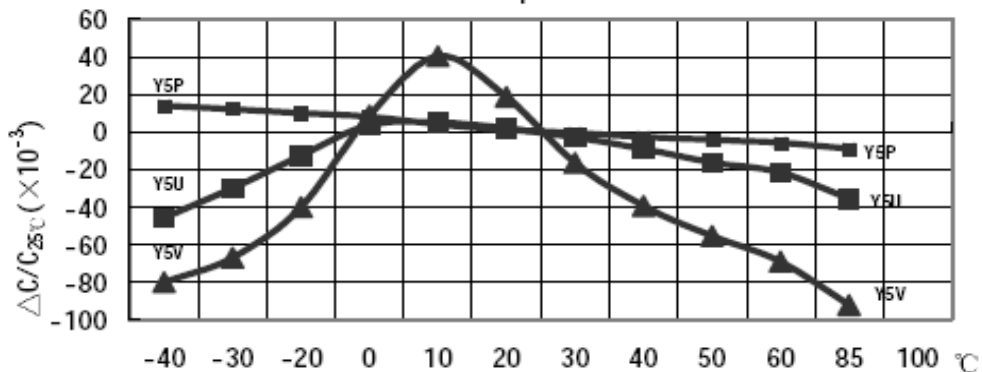

SL 温度特性

SL Temperature Characteristic
SL (+100~-1000ppm/°C)

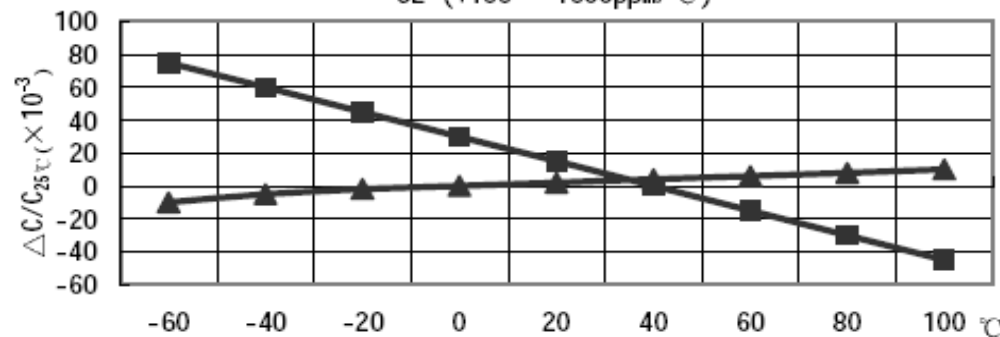

**Super High Voltage Disc
Ceramic Capacitor**

Part No.: I23002

DRW:	Jason	CHKD	Wilson	MATL:	Wilson	TOLERANCE	Mason	DATE	30.04.2011
APPD:	Schumi			FINISH	Jamy		Sheet No.	8 from 14	Customer:

EDCON-COMPONENTS



Lead Style



Lead Style W



Lead Style J



Lead Style L

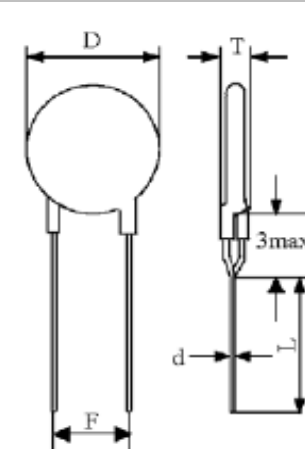

Lead Style P

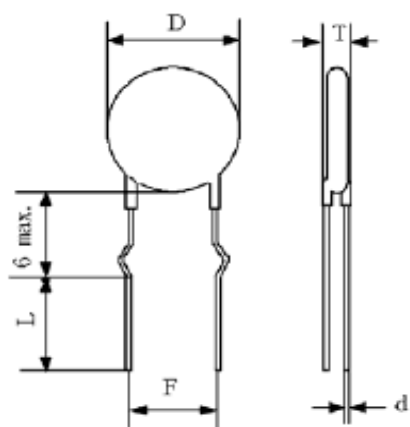

Lead Style K

**Super High Voltage Disc
Ceramic Capacitor**

Part No.: **I23002**

DRW:	Jason	CHKD	Wilson	MATL:	Wilson	TOLERANCE	Mason	DATE	30.04.2011
APPD:	Schumi			FINISH	Jamy		Sheet No.	9 from 14	Customer:

www.edcon-components.com

email: info@edcon-components.com

EDCON-COMPONENTS



Packing Style F



Symbol	Dimension (mm)
P0	12,7 ±0,2
P0	12,7 ±1,0
F	5,0 +0,5/-0,2
P1	3,85 ±0,4
P2	6,35 ±0,4
H0	16,0 ±0,5
H	20,0 ±0,5
W	18,0 ±0,5
W0	8,0 min
W1	9,0 ±0,3
W2	3,0max.
t	0,7 ±0,2
D	To comply with individual sheet
D0	4,0 ±0,2
d	To comply with individual sheet
l	2,0 max.
L	11 max.
T	To comply with individual sheet
Δ S	0,5 max
Δ H	0,5 max

**Super High Voltage Disc
Ceramic Capacitor**

Part No.: **I23002**

DRW:	Jason	CHKD	Wilson	MATL:	Wilson	TOLERANCE	Mason	DATE	30.04.2011
APPD:	Schumi			FINISH	Jamy		Sheet No.		10 from 14

Customer:
email: info@edcon-components.com

EDCON-COMPONENTS



Packing Style V

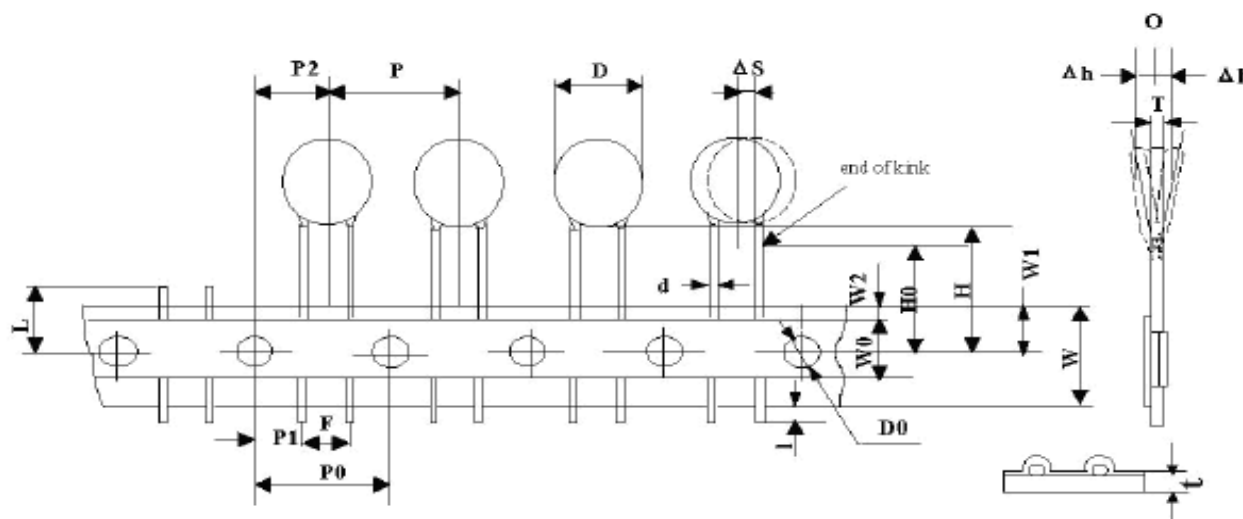

Symbol	Dimension (mm)
P0	15,0 ±0,2
P0	15,0 ±1,0
F	7,5 +0,5/-0,2
P1	3,75 ±0,4
P2	7,5 ±0,4
H0	16,0 ±0,5
H	20,0 ±0,5
W	18,0 ±0,5
W0	11,5 min
W1	9,0 ±0,3
W2	3,0max.
t	0,7 ±0,2
D	To comply with individual sheet
D0	4,0 ±0,2
d	To comply with individual sheet
l	2,0 max.
L	11 max.
T	To comply with individual sheet
Δ S	0,5 max
Δ H	0,5 max

**Super High Voltage Disc
Ceramic Capacitor**

Part No.: **I23002**

DRW:	Jason	CHKD	Wilson	MATL:	Wilson	TOLERANCE	Mason	DATE	30.04.2011	Customer:
APPD:	Schumi			FINISH	Jamy			Sheet No.	11 from 14	

EDCON-COMPONENTS



Packing Style U



Symbol	Dimension (mm)
P0	12,7 ±0,2
P0	25,4 ±1,0
F	10,0 +0,5/-0,2
P1	7,7 ±0,4
P2	
H0	16,0 ±0,5
H	20,0 ±0,5
W	18,0 ±0,5
W0	11,5 min
W1	9,0 ±0,3
W2	3,0max.
t	0,7 ±0,2
D	To comply with individual sheet
D0	4,0 ±0,2
d	To comply with individual sheet
l	2,0 max.
L	11 max.
T	To comply with individual sheet
Δ S	0,5 max
Δ H	0,5 max

**Super High Voltage Disc
Ceramic Capacitor**

Part No.: **I23002**

DRW:	Jason	CHKD	Wilson	MATL:	Wilson	TOLERANCE	Mason	DATE	30.04.2011	Customer:
APPD:	Schumi			FINISH	Jamy			Sheet No.	12 from 14	

www.edcon-components.com

email: info@edcon-components.com

EDCON-COMPONENTS



Ordering Informations

Serie	Range	Tolerance Code	Material Code	Voltage Code	Lead Length	Lead Style	Lead Pitch	Lead Diameter	ROHS	Packing Code
-------	-------	----------------	---------------	--------------	-------------	------------	------------	---------------	------	--------------

I23002	222	K	5P	V	11	L	D	8	R	BU
---------------	------------	----------	-----------	----------	-----------	----------	----------	----------	----------	-----------

222= 2200pf	K= ±10%	5P= Y5P	V= 6KV	11= 11mm	L= Style L	D= Pitch 10mm	8= 0,80mm	R= ROHS Conform	BU= Bulk Ware
				25= 25mm	P= Style P			N= NON ROHS Conform	TF= Tape Style F
					W= Style W				TV= Tape Style U
					J= Style J				TU= Tape Style U
					K= Style K				

**Super High Voltage Disc
Ceramic Capacitor**

Part No.: **I23002**

DRW:	Jason	CHKD	Wilson	MATL:	Wilson	TOLERANCE	Mason	DATE	30.04.2011
APPD:	Schumi			FINISH	Jamy		Sheet No.		13 from 14

Customer:



Soldering Profile Curve

Classification Reflow Profile (JEDEC J-STD-020C)



Super High Voltage Disc Ceramic Capacitor	
Part No.:	I23002
Customer:	

DRW:	Jason	CHKD	Wilson	MATL:	Wilson	TOLERANCE	Mason	DATE	30.04.2011
APPD:	Schumi			FINISH	Jamy		Sheet No.	14 from 14	