

EDCON-COMPONENTS

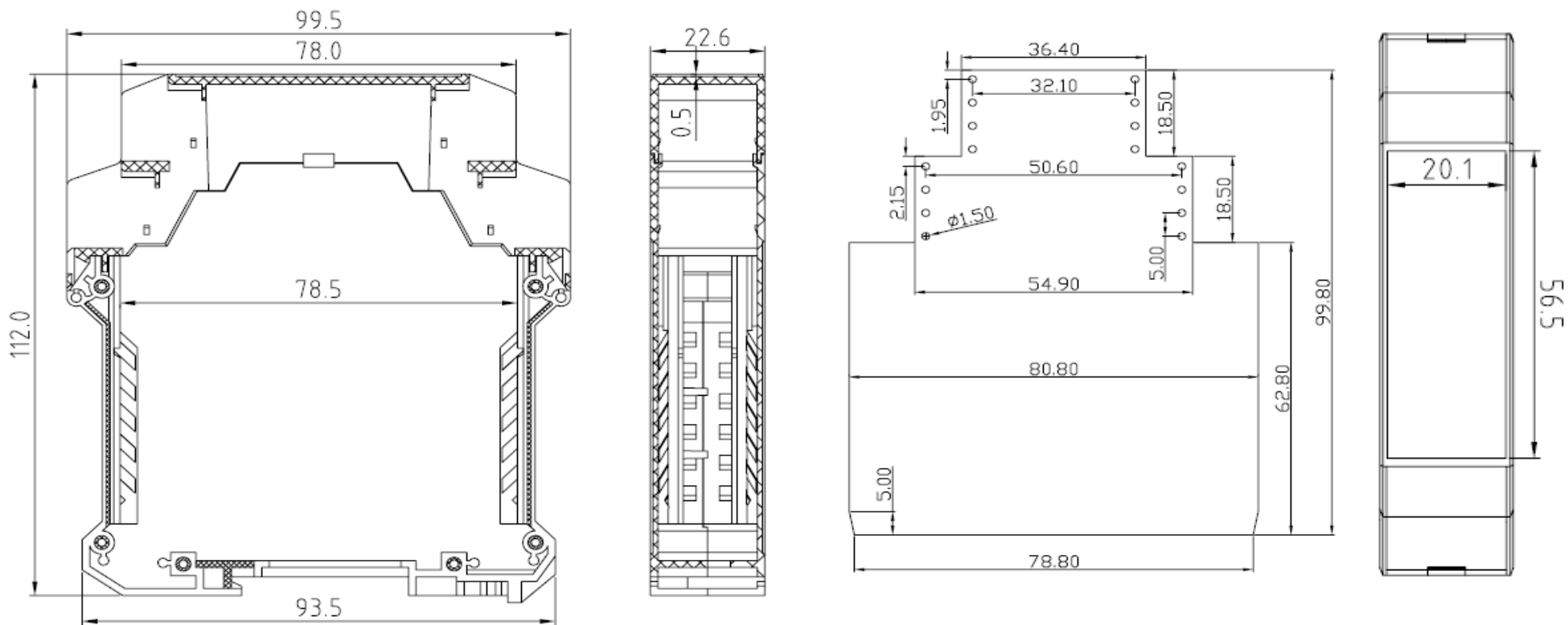

Technical Drawing



DIN RAIL-CASE

Part No.: **H36001**

Customer:

DRW:	Jason	CHKD	Wilson	MATL:	Wilson	TOLERANCE	Mason	DATE	10.04.2009
APPD:	Schumi			FINISH	Jamy		Sheet No.		1 from 2



Ordering Informations

Serie							
H36001							

DIN RAIL-CASE
Part No.: H36001
Customer:

DRW:	Jason	CHKD	Wilson	MATL:	Wilson	TOLERANCE	Mason	DATE	10.04.2009
APPD:	Schumi			FINISH	Jamy			Sheet No.	2 from 2