

# EDCON-COMPONENTS



## Specifications

Switch Rating:	2A/250VAC
Contact Configuration:	1NO/C
IP-Degree:	IP65
Crust Material:	Stainless Steel
Terminal Type:	Solder Lug Terminal
Switching:	ON / ON / ON-(ON)
Contact Resistance:	≤ 0,02Ω
Insulation Resistance:	≥ 1000MΩ
Dielectric Strength:	1500VAC / 50Hz / 1 min.
Operating Temperature:	. -40°C ~ +85°C
Mechanical Life:	50.000 cycles
Electrical Life:	10.000 cycles
Panel Thickness:	1 ~ 6mm
Torque:	5 ~ 14Nm
Operating Pressure:	About 4N
Operating Distance:	About 1,5Nm

## Material

Contact:	Silver Alloy
Button:	Stainless Steel
Body:	Stainless Steel
Base:	PBT
<b>ROHS:</b>	Made to Order-Code

## Switch Function

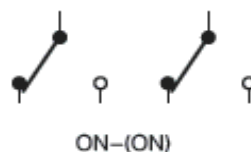

## Mounting Hole

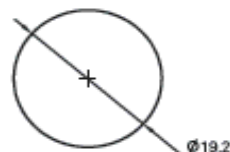

## Drawing

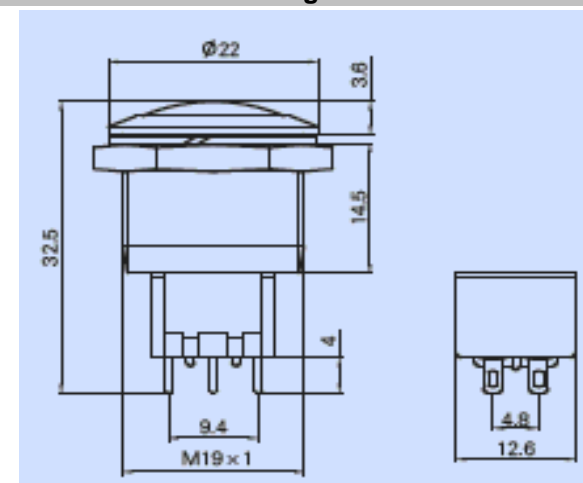

## Knob Style

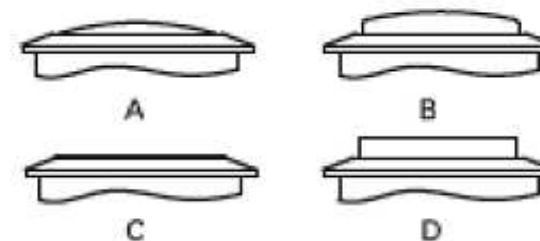

## 22MM Anti-Vandal-Switch

Part No.: **Q36002**

Customer:

DRW:	Jason	CHKD	Wilson	MATL:	Wilson	TOLERANCE	Mason	DATE	20.08.2009
APPD:	Schumi			FINISH	Jamy		Sheet No.	1 from 2	

# EDCON-COMPONENTS



## Ordering Informations

Serie	Knob Style	Contact Structure	Switch Function	Connect Type	Crust Material	ROHS	Packing Style
<b>Q36002</b>	<b>A</b>	<b>60</b>	<b>A</b>	<b>1</b>	<b>S</b>	<b>R</b>	<b>N</b>

<b>A=</b> Type A Ball	<b>60=</b> 2NO/C	<b>A=</b> ON-ON	<b>1=</b> Solder Lug	<b>S=</b> Stainless Steel	<b>R=</b> ROHS Conform	<b>N=</b> White Carton
<b>B=</b> Type B High Ball		<b>B=</b> ON-(ON)			<b>N=</b> NON ROHS Conform	<b>I=</b> Individual Packing
<b>C=</b> Type C Flat						
<b>D=</b> Type D High Flat						

**22MM Anti-Vandal-Switch**

Part No.: **Q36002**

DRW:	Jason	CHKD	Wilson	MATL:	Wilson	TOLERANCE	Mason	DATE	20.08.2009
APPD:	Schumi			FINISH	Jamy		Sheet No.		2 from 2

Customer: