

Data Sheet

Elevated Terminal Block

Pitch: 5,08 mm

Serie: A13M002

Customer Information for special Item

EDCON Customer : 0

Customer Version No. : 0

EDCON-COMPONENTS

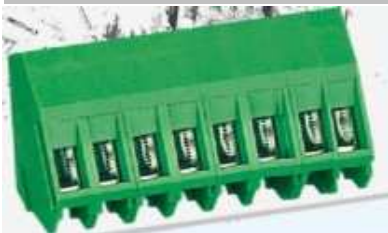

Technical Discription

Drawing (Dimension in mm)

Electrical

Rated Voltage	250 Volt
Rated Current	24A
Wire Range	
Solid Wire	AWG 12~24
Stranged Wire	AWG 12~24
Withstanding Voltage	2,0KV
Insulation Resistance	5000MΩ / 1000V

Mechanical

Operating Temperature	-40°C ~ +115°C
Wire Strip Length	7mm

Dimensions

Pitch (mm)	5,08
Poles	2 + 3Pos. ~ 24 Pos.

Materials

1 Terminal Housing	Thermoplastic (UL94V-0)
2 Clamp	Brass Ni, plated
3 Wire guard	Wire guard solder Pin
4 Terminal screw	Steel Zinc plating
5 Terminal Housing Cover	Thermoplastic (UL94V-0)

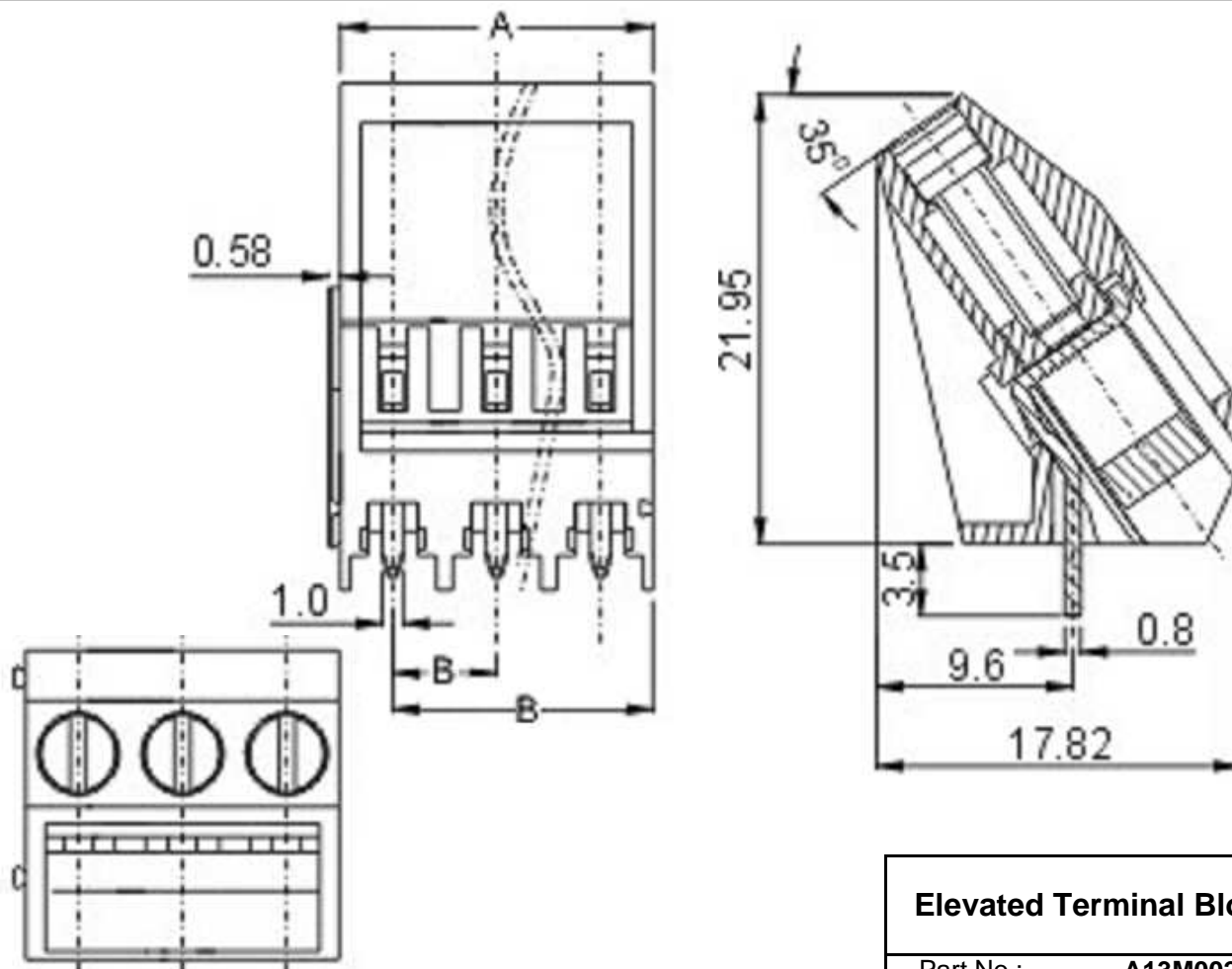

Elevated Terminal Block

Part No.: **A13M002**

Customer:

DRW:	Jason	CHKD	Wilson	MATL:	Wilson	TOLERANCE	Mason	DATE	12.02.2011
APPD:	Schumi			FINISH	Jamy		Sheet No.		1 from 4

EDCON-COMPONENTS

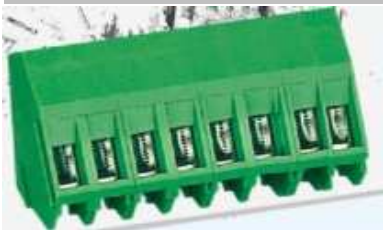

PCB Layout

Dimensions (mm)

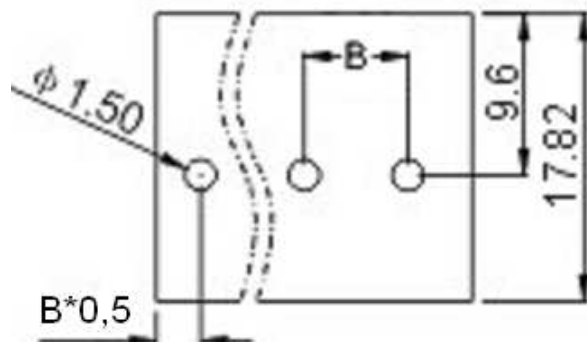

Customer Special Information (Picture, Drawing)

No. of Pos.	A	Tol. A	B	Tol. B
02	10,16	± 0,15	5,08	± 0,15
03	15,24	± 0,15	10,16	± 0,15
04	20,32	± 0,15	15,24	± 0,15
05	25,40	± 0,15	20,32	± 0,15
06	30,48	± 0,15	25,40	± 0,15
07	35,56	± 0,25	30,48	± 0,25
08	40,64	± 0,25	35,56	± 0,25
09	45,72	± 0,25	40,64	± 0,25
10	50,80	± 0,25	45,72	± 0,25
11	55,88	± 0,25	50,80	± 0,25
12	60,96	± 0,25	55,88	± 0,25
13	66,04	± 0,35	60,96	± 0,35
14	71,12	± 0,35	66,04	± 0,35
15	76,20	± 0,35	71,12	± 0,35
16	81,28	± 0,35	76,20	± 0,35
17	86,36	± 0,35	81,28	± 0,35
18	91,44	± 0,35	86,36	± 0,35
19	96,52	± 0,35	91,44	± 0,35
20	101,60	± 0,40	96,52	± 0,40
21	106,68	± 0,40	101,60	± 0,40
22	111,76	± 0,40	106,68	± 0,40
23	116,84	± 0,40	111,76	± 0,40
24	121,92	± 0,40	116,84	± 0,40

Elevated Terminal Block

Part No.: **A13M002**

Customer:

DRW:	Jason	CHKD	Wilson	MATL:	Wilson	TOLERANCE	Mason	DATE	12.02.2011
APPD:	Schumi			FINISH	Jamy		Sheet No.		2 from 4

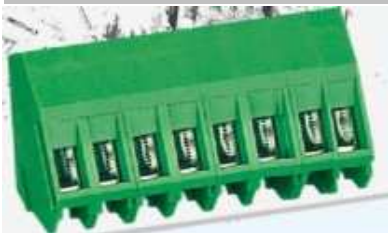

EDCON-COMPONENTS



Ordering Informations

Serie	No. of Pos.	Body Color	No Function	Approval Code	ROHS	Packing	EDCON Cust. No.	Customer Version		
-------	-------------	------------	-------------	---------------	------	---------	-----------------	------------------	--	--

A13M002	02	PG	A	N	R	B				
----------------	-----------	-----------	----------	----------	----------	----------	--	--	--	--

Pitch 5,08	02 = Number of Pos. Standard 2 + 3Pos- ~ 24Pos.	PG = Phoenix Green (Standard) WH = White GN = Green GY = Gray LG = Light Gray OR = Orange BL = Blue BK = Black	A = Slotted Screw Type (Standard)  B = Cross Slotted Screw Type 	N = NON Approval A = UL /UR Approval Please consult EDCON for available B = VDE Approval Please consult EDCON for available C = TÜV Approval Please consult EDCON for available	R = ROHS Conform N = NON ROHS Conform	B = Bulk-Ware I = Individual Package	xxxxxx = Customer Number	xxx = Customer Version ??(Printing)		
---------------	---	---	---	--	--	---	---------------------------------	--	--	--

Elevated Terminal Block	
Part No.:	A13M002
Customer:	

DRW:	Jason	CHKD	Wilson	MATL:	Wilson	TOLERANCE	Mason	DATE	12.02.2011
APPD:	Schumi			FINISH	Jamy		Sheet No.	3 from 4	

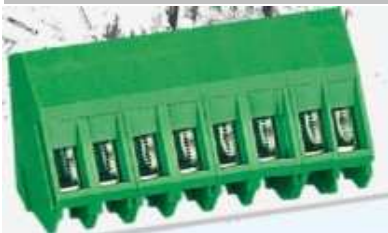

Soldering Profile Curve

Classification Reflow Profile (JEDEC J-STD-020C)



Elevated Terminal Block	
Part No.:	A13M002
Customer:	

DRW:	Jason	CHKD	Wilson	MATL:	Wilson	TOLERANCE	Mason	DATE	12.02.2011
APPD:	Schumi			FINISH	Jamy		Sheet No.	4 from 4	