

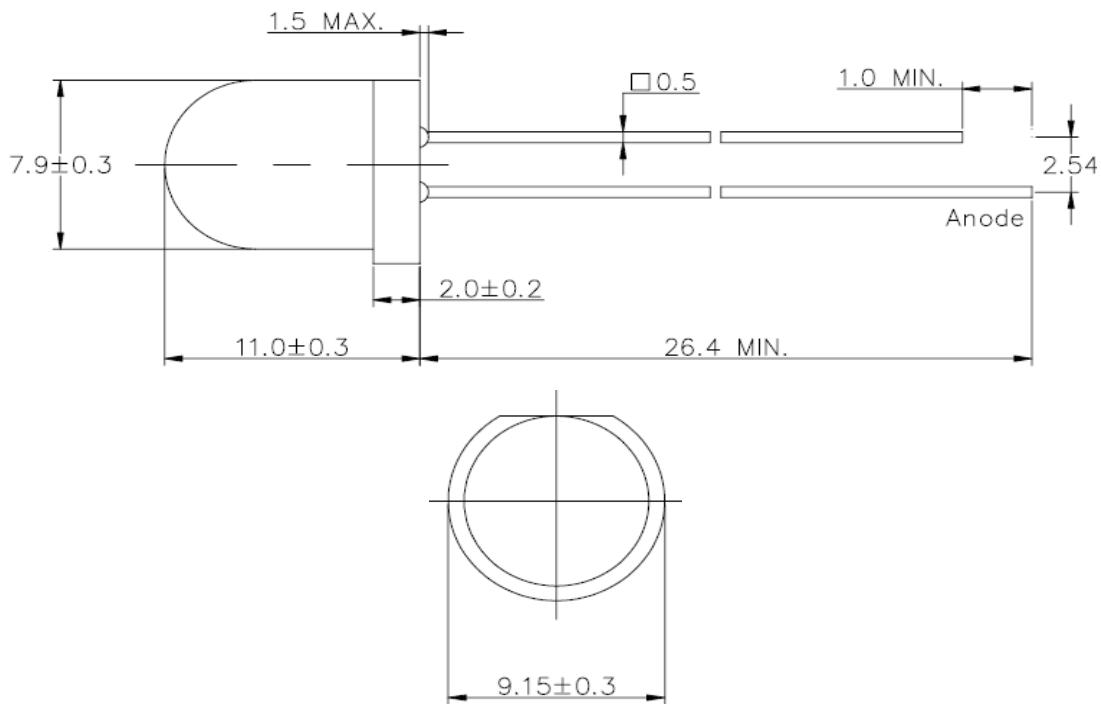

Applications

- Electronic Signs and Signals
- Small Area Illuminations
- Back Lighting
- Other Lighting

Technical Drawing



Notes :

All dimensions in mm tolerance is ± 0.1 mm unless otherwise noted.

Round LED Yellow	
Part No.:	M138006
Customer:	

DRW:	Dong	CHKD	Chang	MATL:	Chui	DATE	05.12.2009
APPD:	Ping			FINISH	Hui	Sheet	1 from 6



Absolute Maximum Ratings

Ta=25°C

Item	Symbol	AlGaInP	Unit
Power Dissipation	P _D	100	mW
DC Forward Current	I _F	20	mA
Pulsed Forward Current	I _{FP} *	160	mA
Reverse Voltage	V _R	5	V
Operating Temperature	T _{OP}	-40 to 85	°C
Storage Temperature	T _{ST}	-40 to 85	°C

* 0.1 msec pulse, 10% duty cycle

Electrical / Optical Characteristics

I_F=20mA Ta=25°C

Emitting Color	Yellow		
Material	AlGaInP		
Forward Voltage	typ.	2.0	V _F
	max.	2.4	V _F
Wavelength typ.	λ _D	595	nm
	λ _P	590	nm
	Δλ	30	nm
Color Temperature	min.	---	K
	max.	---	K
Luminous Intensity *	min.	8000	mcd
	typ.	10000	mcd
Reverse Current	max.	---	μA
Viewing Angle	2θ _{1/2}	30	

* Per NIST standards

**Round LED
Yellow**

Part No.: **M138006**

Customer:

DRW:	Dong	CHKD	Chang	MATL:	Chui	DATE	05.12.2009
APPD:	Ping			FINISH	Hui	Sheet	2 from 6



Curve

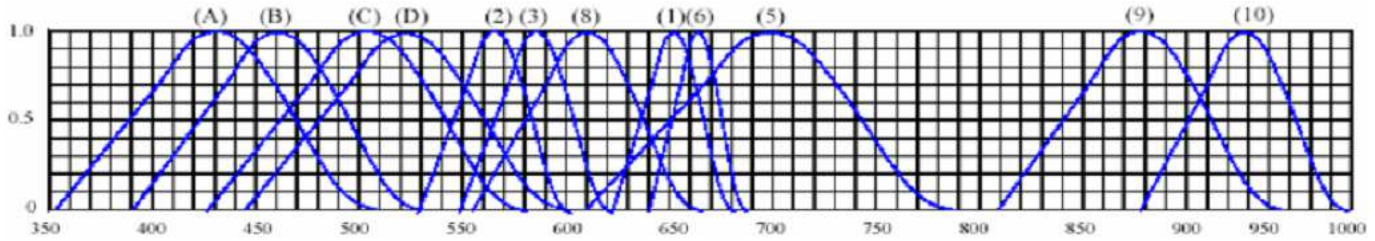

Wavelength (nm)

Relative Intensity vs Wavelength

(1)	GaAsP / GaAs 655nm Red	(9)	GaAlAs 880nm
(2)	GaP 568nm Yellow Green	(10)	GaAs & GaAlAs 940nm
(3)	GaAsP / GaP 585nm Yellow	(A)	GaN 430nm Blue
(4)	GaAsP / GaP 635nm Orange & Red	(B)	InGaN 470nm Blue
(5)	GaP 700nm Red	(C)	InGaN 502nm Green
(6)	GaAlAs / GaAs 660nm Red	(D)	InGaN 523nm Green
(8)	GaAsP / GaP 610nm Red		

**Round LED
Yellow**

Part No.: **M138006**

Customer:

DRW:	Dong	CHKD	Chang	MATL:	Chui	DATE	05.12.2009
APPD:	Ping			FINISH	Hui	Sheet	3 from 6



Curve

FORWARD CURRENT VS. FORWARD VOLTAGE

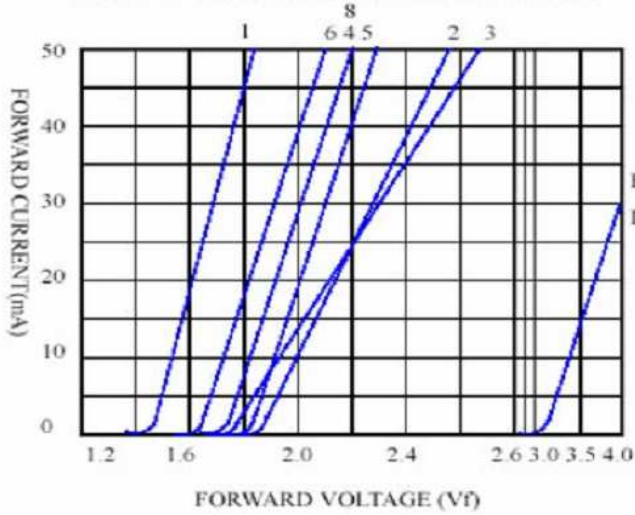

RELATIVE LUMINOUS INTENSITY VS. FORWARD CURRENT

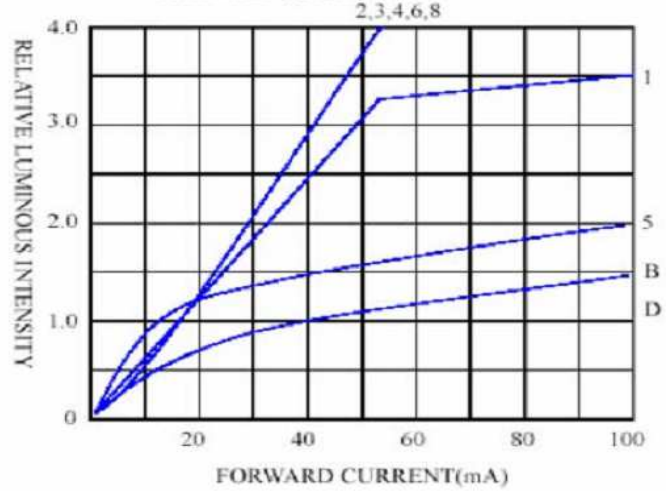

FORWARD CURRENT VS. AMBIENT TEMPERATURE

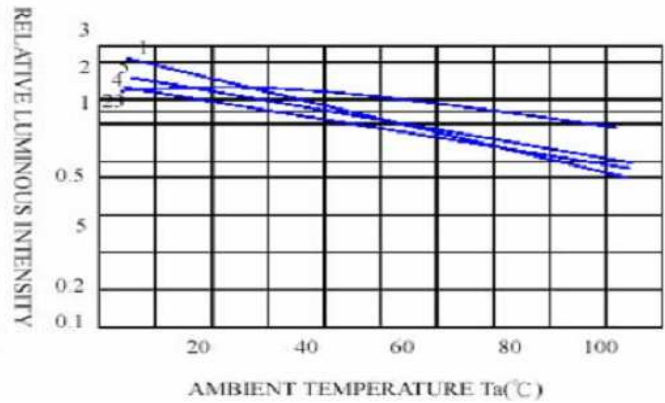
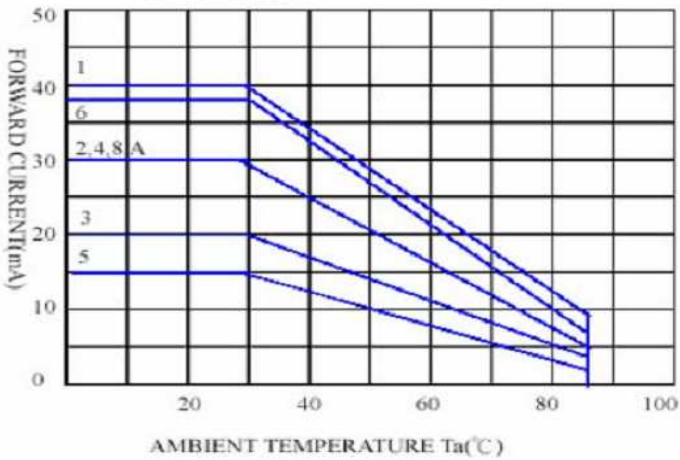

**Round LED
 Yellow**

Part No.: **M138006**

Customer:

DRW:	Dong	CHKD	Chang	MATL:	Chui	DATE	05.12.2009
APPD:	Ping			FINISH	Hui	Sheet	4 from 6



Solder Condition

Lead Free Solder



Round LED Yellow	
Part No.:	M138006
Customer:	

DRW:	Dong	CHKD	Chang	MATL:	Chui	DATE	05.12.2009
APPD:	Ping			FINISH	Hui	Sheet	5 from 6



Color table curve

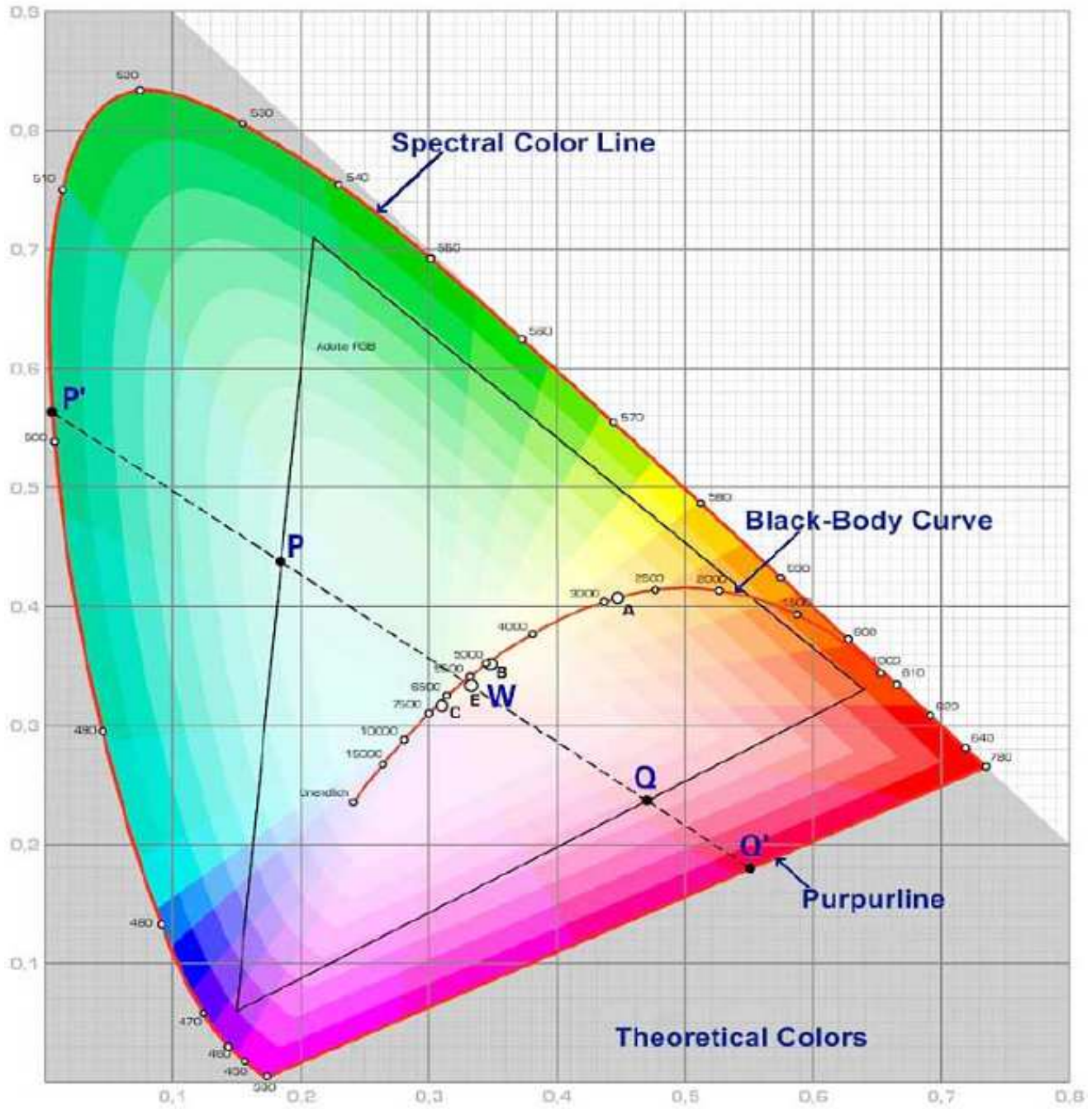

Round LED Yellow	
Part No.:	M138006
Customer:	

DRW:	Dong	CHKD	Chang	MATL:	Chui	DATE	05.12.2009
APPD:	Ping			FINISH	Hui	Sheet	6 from 6