

# EDCON-COMPONENTS



Ac-Socket: ESS301-4

## ■ SPECIFICATIONS

DIELECTRIC STRENGTH	AC3000V-60sec. BETWEEN POLES
INSULATION RESISTANCE	BETWEEN POLES BY DC500V MIN 1000M $\Omega$
CONTACT RESISTANCE	ATTACHED TO POWER CONNECTOR MAX 50 M $\Omega$ AT 10A
HEAT RESISTANCE	100 $\pm$ 5 $^{\circ}$ C FOR 1HR
FORMING STRENGTH OF CONTACT AND BODY	STATIC LOAD OF 10 POUNDS/60sec
STRENGTH OF SCREW MOUNTING	ROTATIONAL TORQUE OF 8KG/CM. 5sec
IMPACT TEST	0.5KG 1TIMES ACCORDING TO UI1950
RATING	250VAC 10A (2.5A)

## ■ DIMENSIONS

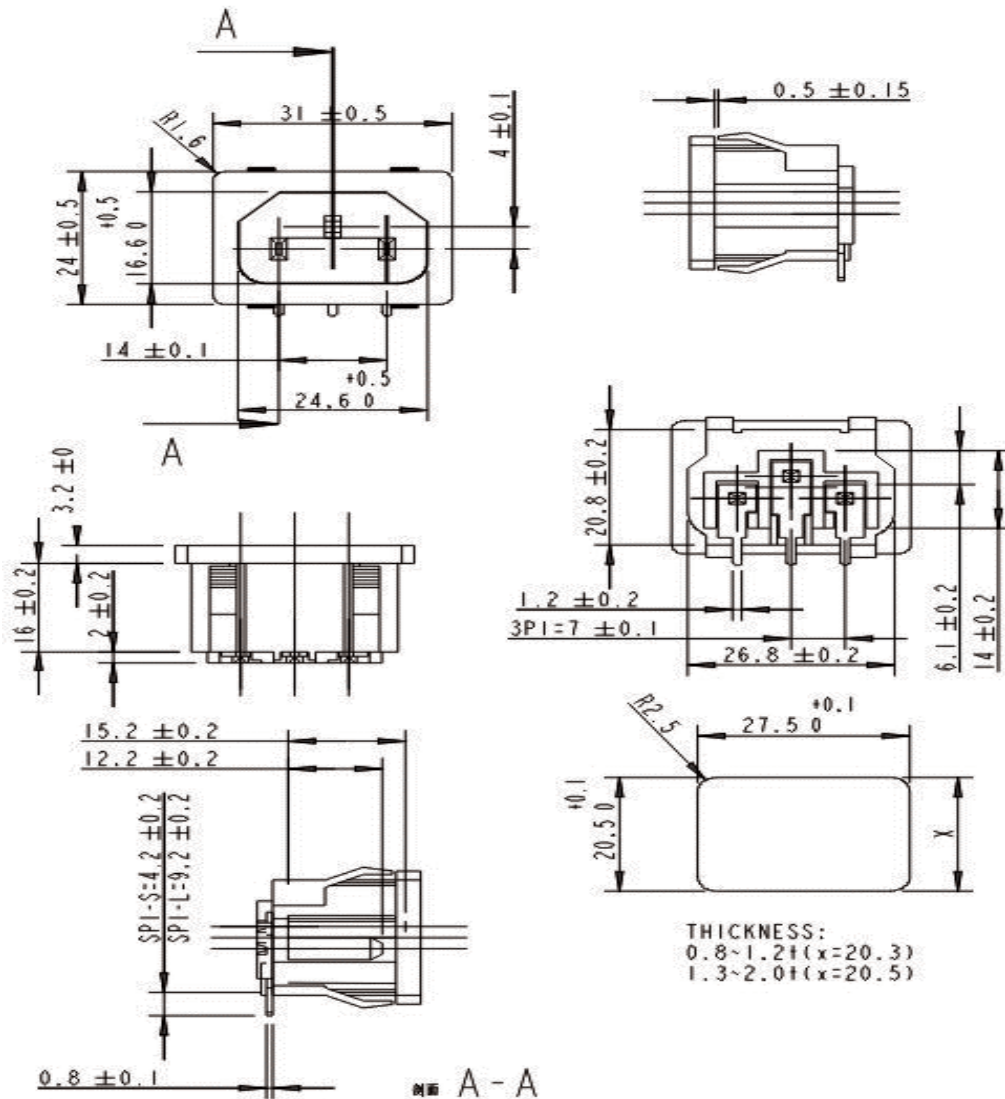

Copyright © by EDCON-COMPONENTS Marco Schmitz 28.09.2007