

EDCON-COMPONENTS

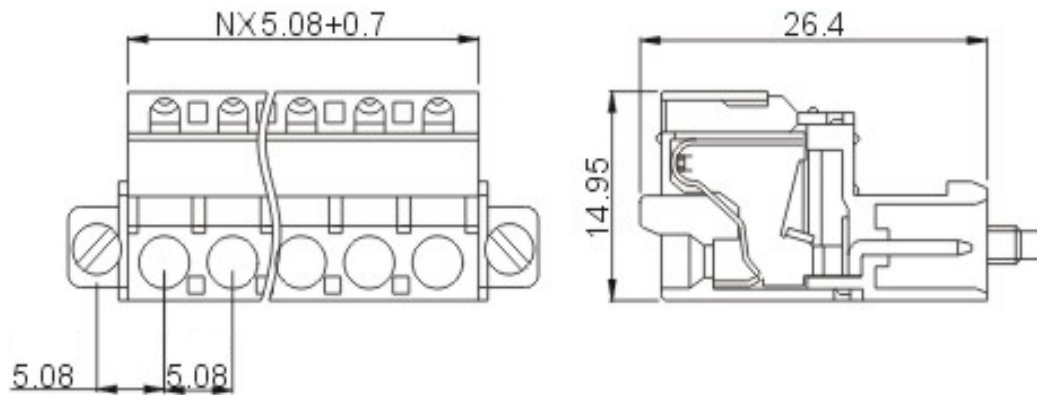

Drawing



P.C.B. Layout

Specification

APPROVAL



Electrical

Standard	UL	IEC
Rated voltage	300V	320V
Rated current	10A	20A
Wire range	26-12 AWG	2.5mm ²
Withstanding voltage	AC 2500V/1min	

Mechanical

Ambient temperature	-40°C ~ +105°C
Strip length	10mm

Dimensions

Pitch	5.08mm
Poles	2P - 16P

Material

Housing	PA66 (UL94V-0)
Contact	Phosphor Bronze
Wire guard	Stainless steel



Certification



Pluggable Terminal Block /
Pitch 5.08mm

Part No.: A14M015

Customer:

DRW:	Bill	CHKD	Lord	MATL:	Jimmy	TOLERANCE	Sam	DATE	14.3.2009
APPD:	Louis			FINISH	Georg			Sheet No.	1 from 3

www.edcon-components.com

email: info@edcon-components.com

EDCON-COMPONENTS



Ordering Informations

Serie	-	No. of Pole	Body-Color	-	Customer Request
A14M015	-	XX	XX	-	X

XX = total	WH - white
02	GN - green
...	GR - gray
16	LG - light gray
	PG - Phoenix Green
	OR - orange
	BL - blue
	BK - black



Certification



Pluggable Terminal Block /
Pitch 5.08mm

Part No.: A14M015

Customer:

DRW:	Bill	CHKD	Lord	MATL:	Jimmy	TOLERANCE	Sam	DATE	14.3.2009
APPD:	Louis			FINISH	Georg			Sheet No.	2 from 3

www.edcon-components.com

email: info@edcon-components.com

EDCON-COMPONENTS



Soldering - Profil

Classification Reflow Profile (JEDEC J-STD-020C)



Pluggable Terminal Block /
Pitch 5.08mm

Part No.: A14M015

Customer:

DRW:	Bill	CHKD	Lord	MATL:	Jimmy	TOLERANCE	Sam	DATE	14.3.2009
APPD:	Louis			FINISH	Georg		Sheet No.	3 from 3	

www.edcon-components.com

email: info@edcon-components.com