

# EDCON-COMPONENTS

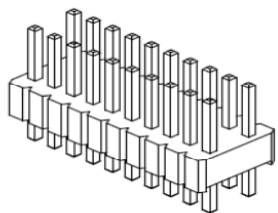

## Specifications

Current Rating:	1 Ampere
Insulator Resistance:	5000 Megaohm min.
Dielectric Withstanding:	AC 500V
Operating Temperature:	.-40°C to +105°C
Contact Material:	Copper, Alloy
Insulator Material:	Polyester, UL 94V-0
Standard:	P.B.T.
Contact Plating:	Tin, Gold or Selective Plated
Standard:	Gold Flash Overall
Selectiv Plating:	Gold flash plated on contact area / tin plated on solder area
Max. Processing Temp.	230°C for 60 seconds

## P.C.B Layout

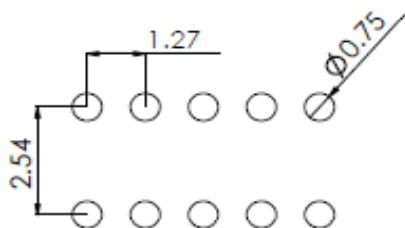

## Drawing ( dimensions all into mm)

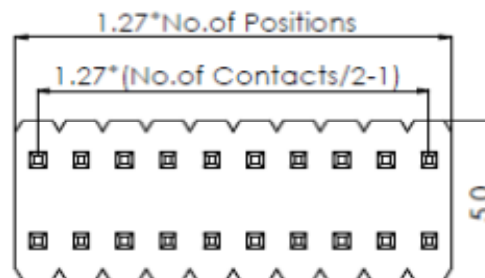
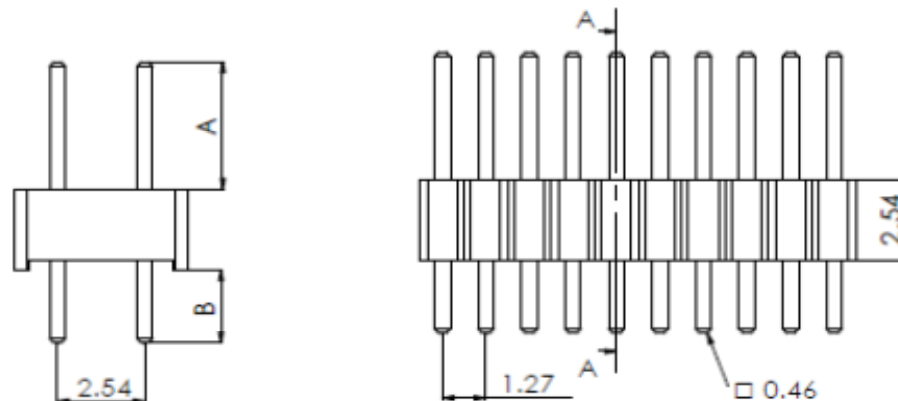

Tolerances unless otherwise specified (mm)									
x	x.x	x.xx	x.xxx	Angle					
±	±	±	±	±3°					
DRW:	Jason	CHKD	Wilson	MATL:	Wilson	TOLERANCE	Mason	DATE	06.09.2018
APPD:	Schumi			FINISH	Jamy			Sheet No.	1 from 4

PIN Header / Dual Row / Single Body / Pitch 1,27mm	
Part No.:	<b>T51C1031</b>
Customer:	

# EDCON-COMPONENTS

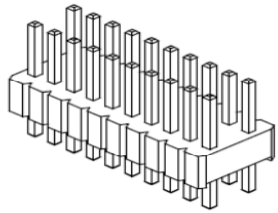

## Pin Code length table free configuration

Order Code	Dimension (mm)		
	A	B	TL
A01	3,00	2,30	7,84
A02	6,00	3,00	11,54
A03			
A04			
A05			
A06			
A07			
A08			
A09			
A10			
A11			
A12			
A13			
A14			
A15			
A16			
A17			
A18			
A19			
A20			
A21			
A22			

Order Code	Dimension (mm)		
	A	B	
A23			
A24			
A25			
A26			
A27			
A28			
A29			
A30			
A31			
A32			
A33			
A34			
A35			
A36			
A37			
A38			
A39			
A40			
A41			
A42			
A43			
A44			

Order Code	Dimension (mm)		
	A	B	
A45			
A46			
A47			
A48			
A49			
A50			
A51			
A52			
A53			
A54			
A55			
A56			
A57			
A58			
A59			
A60			
A61			
A62			
A63			
A64			
A65			
A66			

PIN Header / Dual Row / Single Body / Pitch 1,27mm

Part No.: **T51C1031**

Customer:

DRW:	Jason	CHKD	Wilson	MATL:	Wilson	TOLERANCE	Mason	DATE	06.09.2018
APPD:	Schumi			FINISH	Jamy		Sheet No.		2 from 4

# EDCON-COMPONENTS

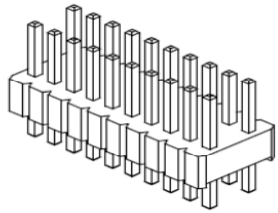

## Ordering Informations

Serie	No. of Pos.	Construction	Contact Plating	Material	Polarisation Peg	Pin Length Code	ROHS	Packing		
<b>T51C1031</b>	<b>XX</b>	<b>ST</b>	<b>G0</b>	<b>PB</b>	<b>N</b>	<b>A01</b>	<b>R</b>	<b>BU</b>		

<b>XX</b> = total pin of header	<b>ST</b> = straight THT	<b>G0</b> = Gold Flash (Standard)	<b>PB</b> =P.B.T (Standard)	<b>N</b> = No	look table page 2	<b>N</b> =NO ROHS	<b>BU</b> = Bulk (Standard)
		<b>T0</b> = Tin plated	<b>PY</b> = Polyester UL94V-0			<b>R</b> =ROHS conform	<b>TU</b> = Tube w/o Cap
		<b>GA</b> = 10µ Gold Plating	<b>NY</b> = Nylon-6T				<b>TC</b> = Tube w. pic and Place Cap
		<b>GB</b> = 15µ Gold Plating					<b>TY</b> = Tray packing w/o Cap
		<b>GC</b> = 20µ Gold Plating					<b>TR</b> = Tape/Reel w. pic and Place Cap
		<b>S0</b> = Selectiv Plating Gold Flash / Tin					
		<b>TN</b> = Tin Plated					

PIN Header / Dual Row / Single Body / Pitch 1,27mm
Part No.: <b>T51C1031</b>
Customer:

DRW:	Jason	CHKD	Wilson	MATL:	Wilson	TOLERANCE	Mason	DATE	06.09.2018
APPD:	Schumi			FINISH	Jamy		Sheet No.		3 from 4

[www.edcon-components.com](http://www.edcon-components.com)

email: [info@edcon-components.com](mailto:info@edcon-components.com)

# EDCON-COMPONENTS

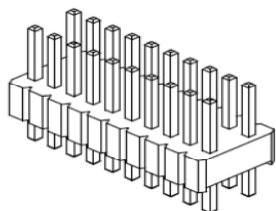

## Soldering Profile for Lead Soldering ( P.B.T. )

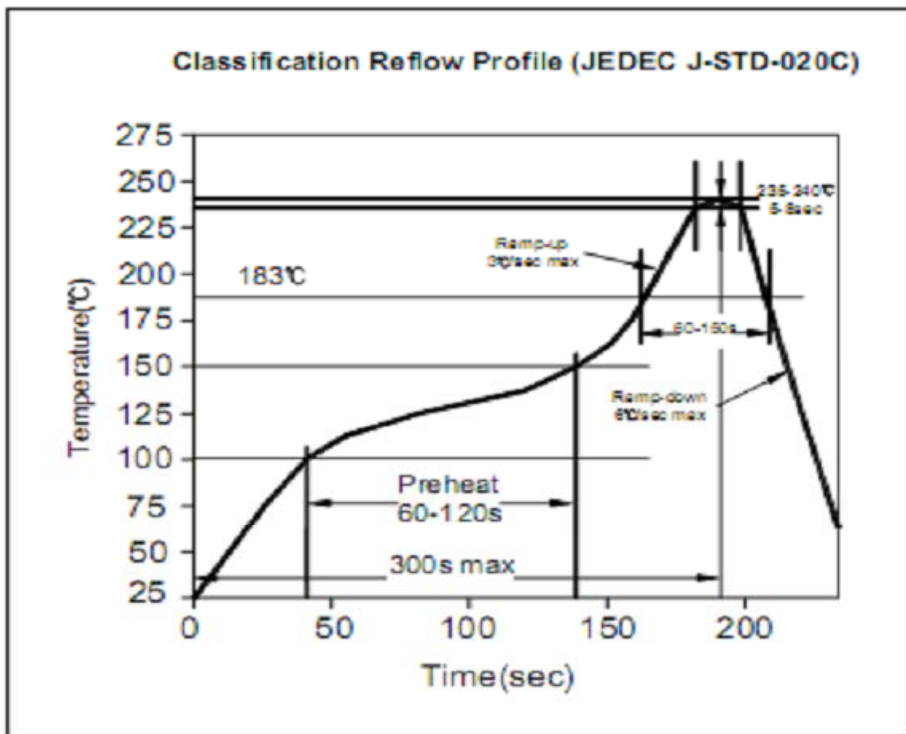

## Soldering Profile for Lead Free Soldering ( Nylon 6T )

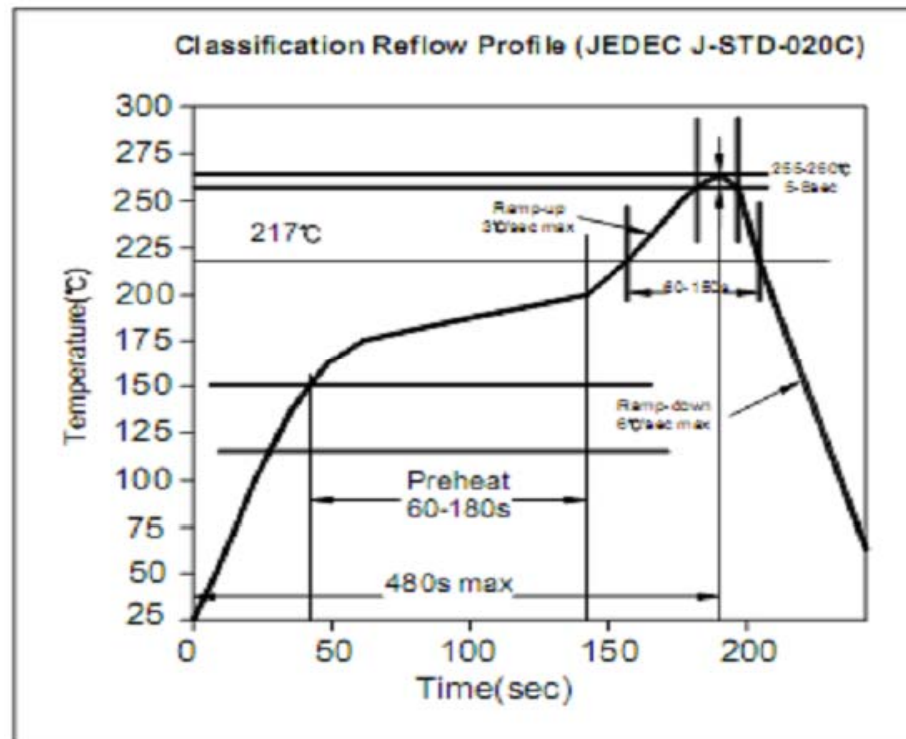

PIN Header / Dual Row / Single Body / Pitch 1,27mm	
Part No.:	<b>T51C1031</b>
Customer:	

DRW:	Jason	CHKD	Wilson	MATL:	Wilson	TOLERANCE	Mason	DATE	06.09.2018
APPD:	Schumi			FINISH	Jamy		Sheet No.		4 from 4