

EDCON-COMPONENTS

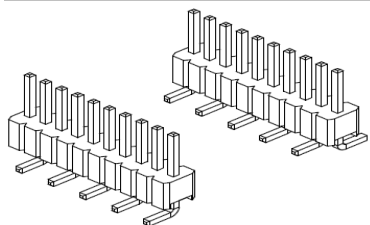

Specifications

Current Rating:	1 Ampere
Insulator Resistance:	5000 Megaohm min.
Dielectric Withstanding:	AC 500V
Operating Temperature:	.-40°C to +105°C
Contact Material:	Copper, Alloy
Insulator Material:	Polyester, UL 94V-0
Standard:	P.B.T.
Contact Plating:	Tin, Gold or Selective Plated
Standard:	Gold Flash Overall
Selectiv Plating:	Gold flash plated on contact area / tin plated on solder area
Max. Processing Temp.	230°C for 60 seconds

P.C.B Layout

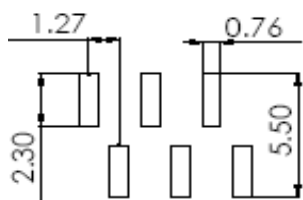

A TYPE

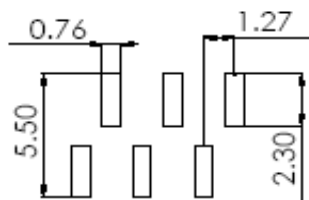

B TYPE

Drawing (dimensions all into mm)

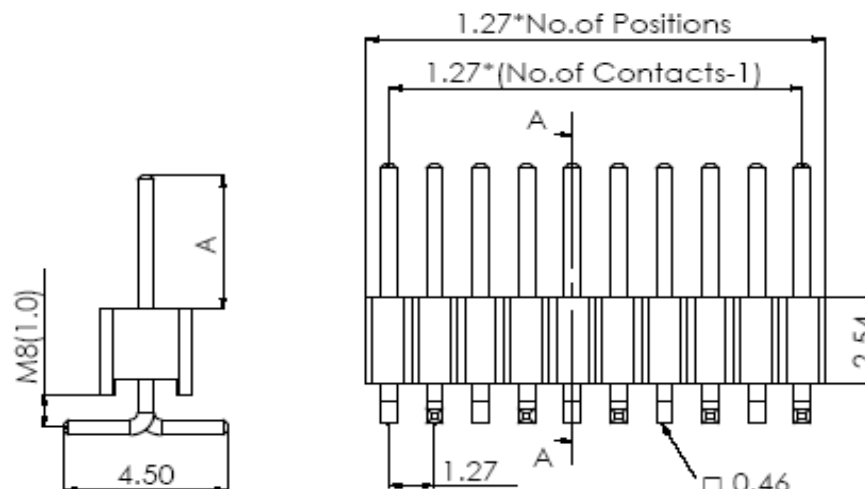

A TYPE

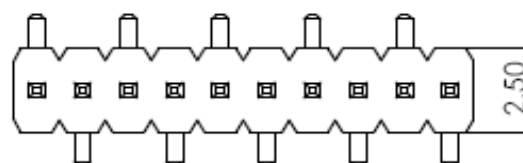

B TYPE

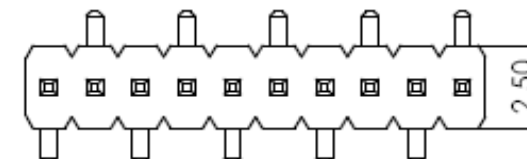

PIN Header / Single Row / Single Body / Pitch 1,27mm

Part No.: **T51C1010**

Customer:

DRW:	Jason	CHKD	Wilson	MATL:	Wilson	TOLERANCE	Mason	DATE	06.01.2009
APPD:	Schumi			FINISH	Jamy		Sheet No.		1 from 4

EDCON-COMPONENTS

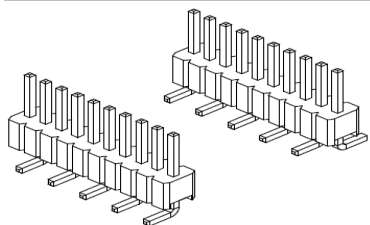

Pin Code length table free configuration

Order Code	Dimension (mm)		
	A	M8	
A01	4,00	1,00	
A02			
A03			
A04			
A05			
A06			
A07			
A08			
A09			
A10			
A11			
A12			
A13			
A14			
A15			
A16			
A17			
A18			
A19			
A20			
A21			
A22			

Order Code	Dimension (mm)		
	A	M8	
A23			
A24			
A25			
A26			
A27			
A28			
A29			
A30			
A31			
A32			
A33			
A34			
A35			
A36			
A37			
A38			
A39			
A40			
A41			
A42			
A43			
A44			

Order Code	Dimension (mm)		
	A	M8	
A45			
A46			
A47			
A48			
A49			
A50			
A51			
A52			
A53			
A54			
A55			
A56			
A57			
A58			
A59			
A60			
A61			
A62			
A63			
A64			
A65			
A66			

PIN Header / Single Row / Single Body / Pitch 1,27mm

Part No.: **T51C1010**

DRW:	Jason	CHKD	Wilson	MATL:	Wilson	TOLERANCE	Mason	DATE	06.01.2009
APPD:	Schumi			FINISH	Jamy		Sheet No.		2 from 4

Customer:

EDCON-COMPONENTS

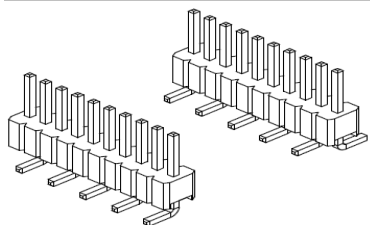

Ordering Informations

Serie	No. of Pos.	Construction	Contact Plating	Material	Circuit	Pin Length Code	ROHS	Packing		
T51C1010	XX	SS	G0	PB	A	A01	R	BU		

XX = total pin of header	SS = straight SMT	G0 = Gold Flash (Standard)	PB =P.B.T (Standard)	A = Type A	look table page 2	N =NO ROHS conform	BU = Bulk (Standard)
		T0 = Tin plated	PY = Polyester UL94V-0	B = Type B		R =ROHS conform	TU = Tube w/o Cap
		GA = 10µ Gold Plating	NY = Nylon-6T				TC = Tube w. pic and Place Cap
		GB = 15µ Gold Plating					TY = Tray packing w/o Cap
		GC = 20µ Gold Plating					TR = Tape/Reel w. pic and Place Cap
		S0 = Selectiv Plating Gold Flash / Tin					
		TN = Tin Plated					

PIN Header / Single Row / Single Body / Pitch 1,27mm

Part No.: **T51C1010**

DRW:	Jason	CHKD	Wilson	MATL:	Wilson	TOLERANCE	Mason	DATE	06.01.2009
APPD:	Schumi			FINISH	Jamy		Sheet No.		3 from 4

Customer:

EDCON-COMPONENTS

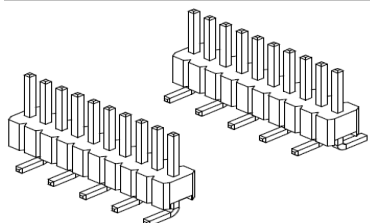

Soldering Profile for Lead Soldering (P.B.T.)



Soldering Profile for Lead Free Soldering (Nylon 6T)



PIN Header / Single Row / Single Body / Pitch 1,27mm

Part No.: **T51C1010**

DRW:	Jason	CHKD	Wilson	MATL:	Wilson	TOLERANCE	Mason	DATE	06.01.2009
APPD:	Schumi			FINISH	Jamy		Sheet No.	4 from 4	Customer:

www.edcon-components.com

email: info@edcon-components.com