

EDCON-COMPONENTS

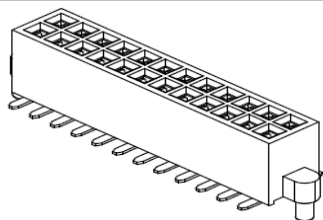

Specifications

Current Rating:	1 Ampere
Insulator Resistance:	5000 Megaohm min.
Contact Resistance:	20m Ohm max.
Dielectric Withstanding:	AC 500V
Operating Temperature:	.-40°C to +105°C
Contact Material:	Phosphor Bronze
Insulator Material:	Polyester, UL 94V-0
Standard:	Nylon 6T
Contact Plating:	Tin, Gold or Selective Plated
Standard:	Gold Flash Overall

P.C.B Layout

Drawing

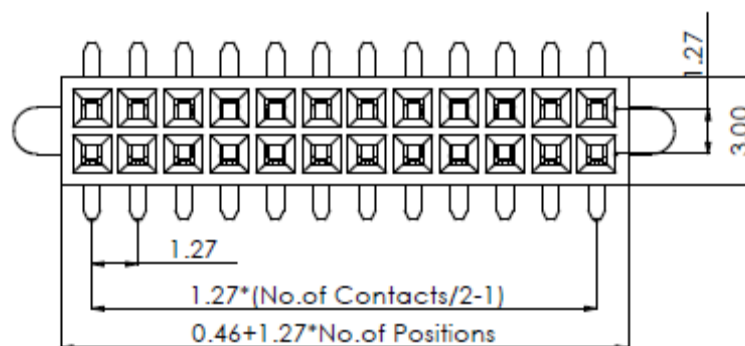
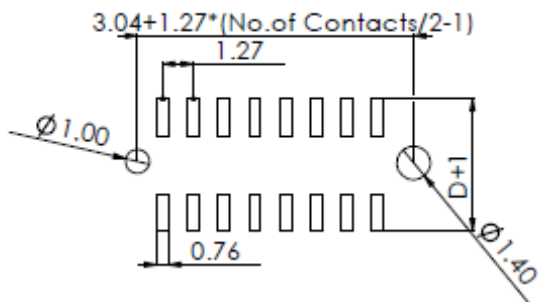
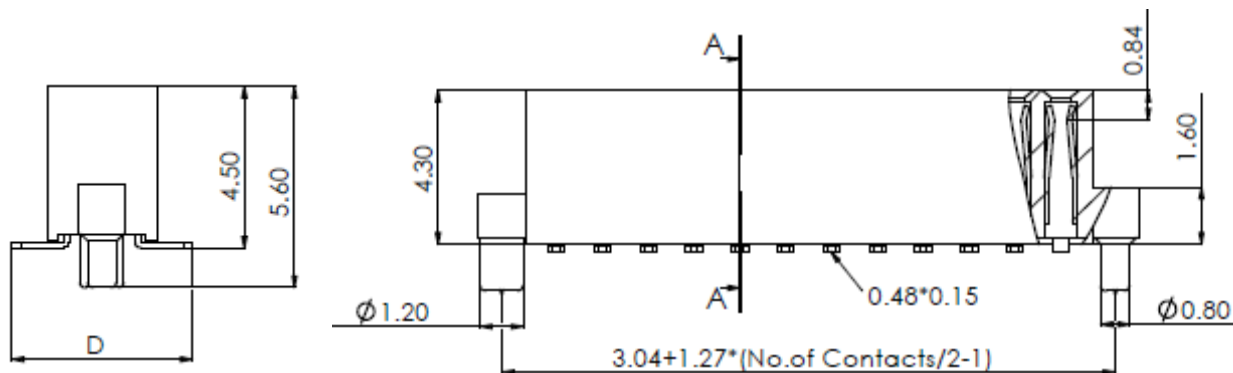

Female Header Pitch 1,27mm
Part No.: T27C1008
Customer:

DRW:	Jason	CHKD	Wilson	MATL:	Wilson	TOLERANCE	Mason	DATE	04.07.2009
APPD:	Schumi			FINISH	Jamy		Sheet No.	1 from 4	

EDCON-COMPONENTS

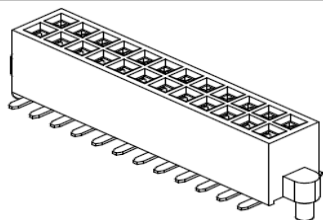

Pin Code length table free configuration

Order Code	Dimension (mm)			
	D			
A01	4,80			
A02				
A03				
A04				
A05				
A06				
A07				
A08				
A09				
A10				
A11				
A12				
A13				
A14				
A15				
A16				
A17				
A18				
A19				
A20				
A21				
A22				

Order Code	Dimension (mm)			
	D			
A23				
A24				
A25				
A26				
A27				
A28				
A29				
A30				
A31				
A32				
A33				
A34				
A35				
A36				
A37				
A38				
A39				
A40				
A41				
A42				
A43				
A44				

Order Code	Dimension (mm)			
	D			
A45				
A46				
A47				
A48				
A49				
A50				
A51				
A52				
A53				
A54				
A55				
A56				
A57				
A58				
A59				
A60				
A61				
A62				
A63				
A64				
A65				
A66				

Female Header Pitch 1,27mm	
Part No.:	T27C1008
Customer:	

DRW:	Jason	CHKD	Wilson	MATL:	Wilson	TOLERANCE	Mason	DATE	04.07.2009
APPD:	Schumi			FINISH	Jamy		Sheet No.		2 from 4

EDCON-COMPONENTS

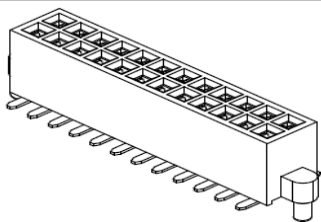

Ordering Informations

Serie	No. of Pos.	Construction	Contact Plating	Material	Special function	Pin Length Code	ROHS	Packing		
T27C1008	XX	SS	G0	PB	N	A01	R	BU		

04 ~ 80Pos.	SS= Straight SMT	G0= Gold Flash (Standard)	PB= P.B.T	N= No	look Table No. 1	N= NO ROHS conform	BU= Bulk (Standard)
		T0= Tin plated					NY= Nylon-6T
		GA= 10µ Gold Plating	PA= PA-46			TC= Tube w. pic and Place Cap	
		GB= 15µ Gold Plating				TY= Tray packing w/o Cap	
		GC= 20µ Gold Plating				TR= Tape/Reel w. pic and Place Cap	
		S0= Selectiv Plating Gold Flash / Tin					

Female Header Pitch 1,27mm	
Part No.:	T27C1008
Customer:	

DRW:	Jason	CHKD	Wilson	MATL:	Wilson	TOLERANCE	Mason	DATE	04.07.2009
APPD:	Schumi			FINISH	Jamy		Sheet No.		3 from 4

EDCON-COMPONENTS

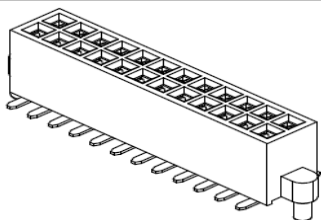

Soldering Profile for Lead Soldering (P.B.T.)



Soldering Profile for Lead Free Soldering (Nylon 6T)



**Female Header Pitch
1,27mm**

Part No.: **T27C1008**

DRW:	Jason	CHKD	Wilson	MATL:	Wilson	TOLERANCE	Mason	DATE	04.07.2009	Customer:
APPD:	Schumi			FINISH	Jamy		Sheet No.	4 from 4		

www.edcon-components.com

email: info@edcon-components.com