

# EDCON-COMPONENTS

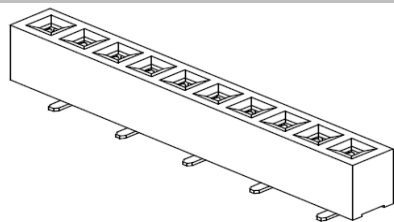

## Specifications

Current Rating:	1 Ampere
Insulator Resistance:	5000 Megaohm min.
Contact Resistance:	20m Ohm max.
Dielectric Withstanding:	AC 500V
Operating Temperature:	-.40°C to +105°C
Contact Material:	Phosphor Bronze
Insulator Material:	Polyester, UL 94V-0
Standard:	Nylon 6T
Contact Plating:	Tin, Gold or Selective Plated
Standard:	Gold Flash Overall

## P.C.B Layout

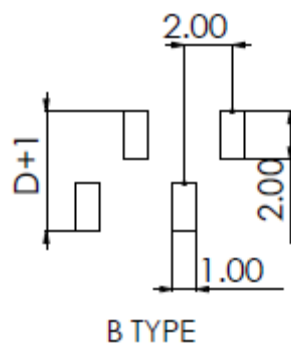
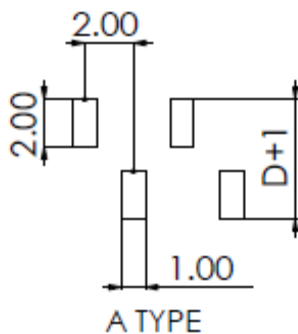

## Drawing

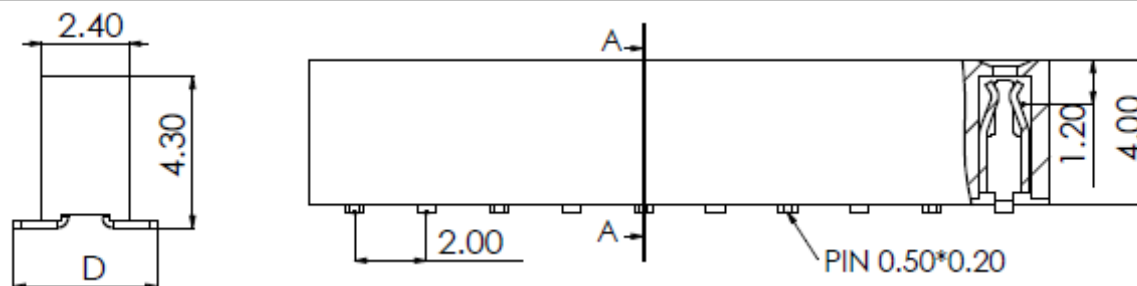

A TYPE

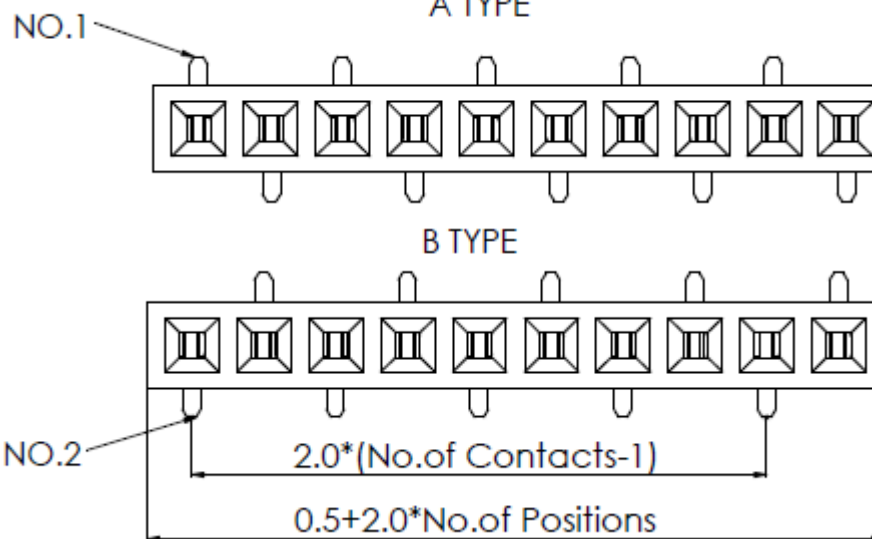

**Female Header Pitch  
2,00mm**

Part No.: **T27B1021**

Customer:

DRW:	Jason	CHKD	Wilson	MATL:	Wilson	TOLERANCE	Mason	DATE	04.06.2009
APPD:	Schumi			FINISH	Jamy		Sheet No.		1 from 4

# EDCON-COMPONENTS

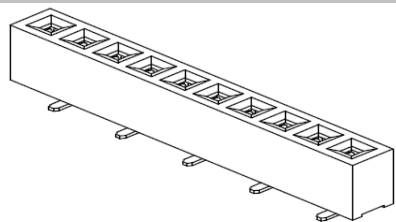

## Pin Code length table free configuration

Order Code	Dimension (mm)			
	D			
A01	4,00			
A02				
A03				
A04				
A05				
A06				
A07				
A08				
A09				
A10				
A11				
A12				
A13				
A14				
A15				
A16				
A17				
A18				
A19				
A20				
A21				
A22				

Order Code	Dimension (mm)			
	D			
A23				
A24				
A25				
A26				
A27				
A28				
A29				
A30				
A31				
A32				
A33				
A34				
A35				
A36				
A37				
A38				
A39				
A40				
A41				
A42				
A43				
A44				

Order Code	Dimension (mm)			
	D			
A45				
A46				
A47				
A48				
A49				
A50				
A51				
A52				
A53				
A54				
A55				
A56				
A57				
A58				
A59				
A60				
A61				
A62				
A63				
A64				
A65				
A66				

<b>Female Header Pitch 2,00mm</b>	
Part No.:	<b>T27B1021</b>
Customer:	

DRW:	Jason	CHKD	Wilson	MATL:	Wilson	TOLERANCE	Mason	DATE	04.06.2009
APPD:	Schumi			FINISH	Jamy		Sheet No.		2 from 4

# EDCON-COMPONENTS

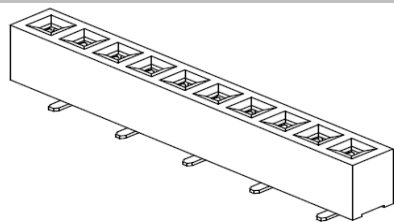

## Ordering Informations

Serie	No. of Pos.	Construction	Contact Plating	Material	Layout Type	Pin Length Code	ROHS	Packing		
<b>T27B1021</b>	<b>XX</b>	<b>SS</b>	<b>G0</b>	<b>PB</b>	<b>A</b>	<b>A01</b>	<b>R</b>	<b>BU</b>		

<b>03 ~ 40Pos.</b>	<b>SS=</b> Straight SMT	<b>G0=</b> Gold Flash (Standard)	<b>PB=</b> P.B.T	<b>A=</b> Type A	look Table No. 1	<b>N=</b> NO ROHS conform	<b>BU=</b> Bulk (Standard)
		<b>T0=</b> Tin plated	<b>NY=</b> Nylon-6T	<b>B=</b> Type B		<b>R=</b> ROHS conform	<b>TU=</b> Tube w/o Cap
		<b>GA=</b> 10µ Gold Plating	<b>PA=</b> PA-46				<b>TC=</b> Tube w. pic and Place Cap
		<b>GB=</b> 15µ Gold Plating					<b>TY=</b> Tray packing w/o Cap
		<b>GC=</b> 20µ Gold Plating					<b>TR=</b> Tape/Reel w. pic and Place Cap
		<b>S0=</b> Selectiv Plating Gold Flash / Tin					

<b>Female Header Pitch 2,00mm</b>	
Part No.:	<b>T27B1021</b>
Customer:	

DRW:	Jason	CHKD	Wilson	MATL:	Wilson	TOLERANCE	Mason	DATE	04.06.2009
APPD:	Schumi			FINISH	Jamy		Sheet No.		3 from 4

# EDCON-COMPONENTS

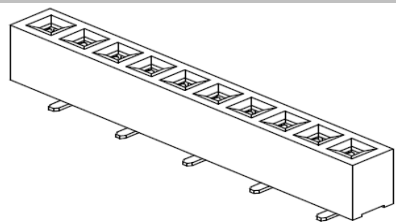

## Soldering Profile for Lead Soldering ( P.B.T. )



## Soldering Profile for Lead Free Soldering ( Nylon 6T )



**Female Header Pitch  
2,00mm**

Part No.: **T27B1021**

DRW:	Jason	CHKD	Wilson	MATL:	Wilson	TOLERANCE	Mason	DATE	04.06.2009
APPD:	Schumi			FINISH	Jamy		Sheet No.	4 from 4	Customer:

[www.edcon-components.com](http://www.edcon-components.com)

email: [info@edcon-components.com](mailto:info@edcon-components.com)