

EDCON-COMPONENTS

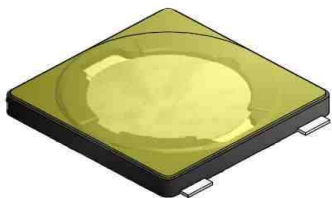

SPECIFICATION:

Current Rating: DC12V / 50mA
 Insulator Resistance: 100 Mega Ω min.
 Contact Resistance: 100 m Ω max.
 Travel: 0,2 / +/- 0,1mm
 Operating Temperature: -40°C to +105°C
 Lifetime: look order code
 Operating Force: look order code

Common Specifications

Life Test	50/80 Cycles / Min with 5VDC 5mA Resistive load Cycles of Operation: As per individual Specifications
Dry Heat Proof	80°C +/- 2°C for 96hours after Test Kept in Normal Condition for 30Min.
Moisture Resistance	60°C +/- 2°C 90~95% RH for 96 Hours After Test, Kept in Normal Condition for 30 Minutes
Cold Proof	-30°C for 96 Hours After Test Kept in Normal Condition for 30 Minutes.
Operating Force	If refers to the maximum load at the time of switching over of the contacts. (Point A in the figure)
Travel	This refers to the state of repeating the contact opening or closing momentarily at the time of the changeover of the switch to ON or OFF. Longer duration of this state

Drawing

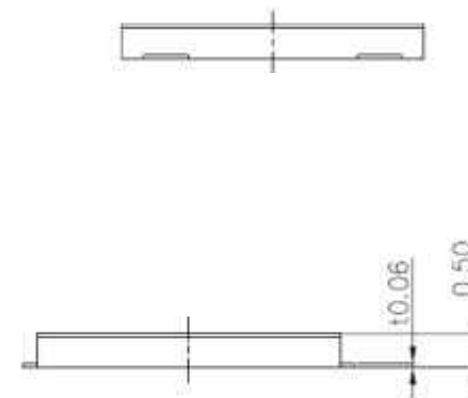
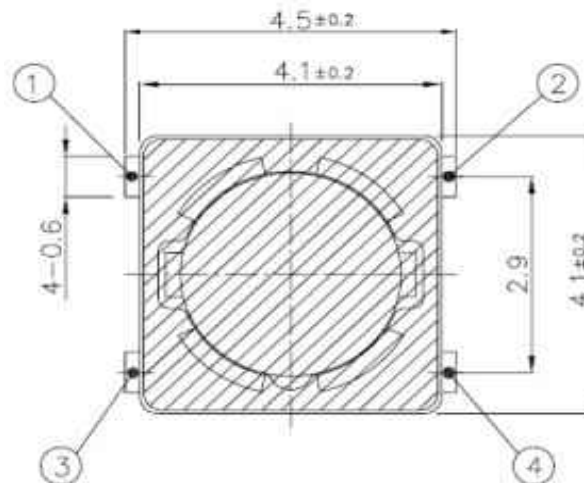

PCB Layout

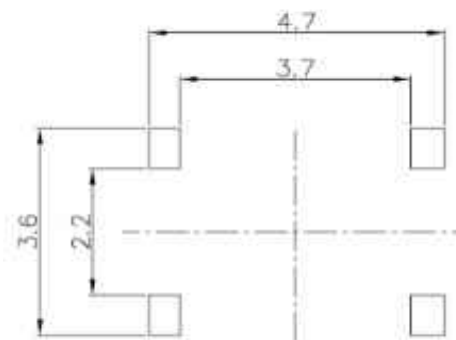

Circuit Diagram

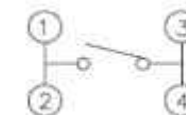

SMT TACT SWITCH

Part No.: **Q12075**

Customer:

DRW:	Jason	CHKD	Wilson	MATL:	Wilson	TOLERANCE	Mason	DATE	02.07.2009
APPD:	Schumi			FINISH	Jamy		Sheet No.		1 from 3

EDCON-COMPONENTS

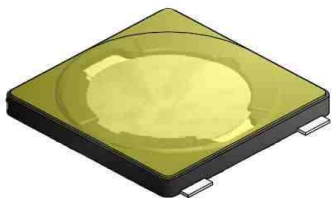

Ordering Informations

Serie	Total height (H)	Function	Operating Force	Function	Electrical life	Function	ROHS	Packing		
Q12075	005	N	161	N	104	N	R	BU102		
	005= 0,50mm	N= No function	161 = 160gr	N= No function	104= 100000 cycles by 160gr. O-Force	N= No function	N= non ROHS	BU102= Bulk 1000PCS		
			251 = 250gr		503= 50000 cycles by 250gr. O-Force		R= ROHS conform	TR= Tape Reel		
			351 = 350gr		303= 30000 cycles by 350gr. O-Force					

SMT TACT SWITCH

Part No.: **Q12075**

Customer:

DRW:	Jason	CHKD	Wilson	MATL:	Wilson	TOLERANCE	Mason	DATE	02.07.2009
APPD:	Schumi			FINISH	Jamy		Sheet No.	2 from 3	

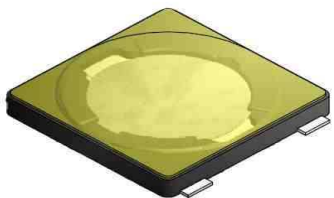

Soldering Profile for Lead Free Soldering

Classification Reflow Profile (JEDEC J-STD-020C)

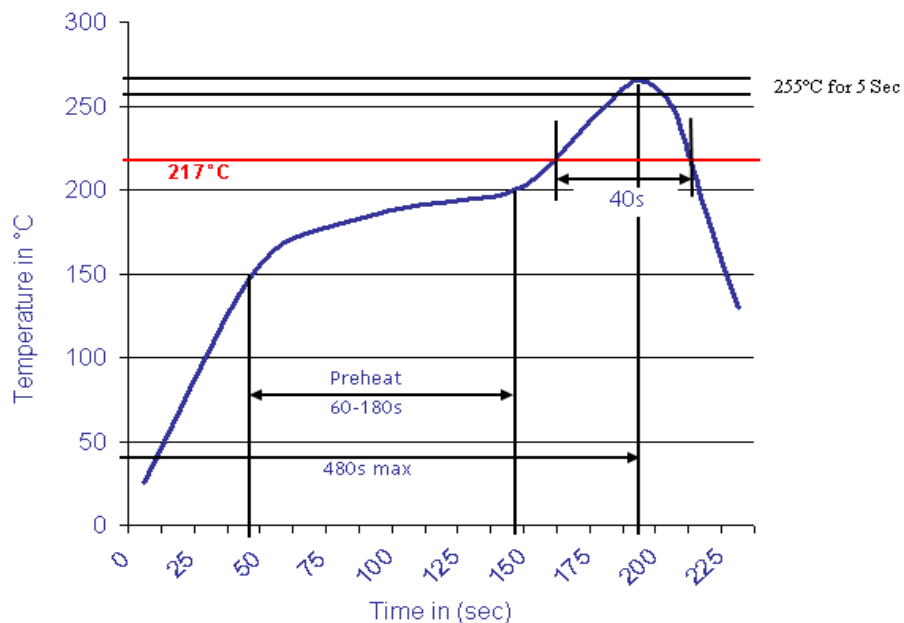

SMT TACT SWITCH

Part No.: **Q12075**

Customer:

DRW:	Jason	CHKD	Wilson	MATL:	Wilson	TOLERANCE	Mason	DATE	02.07.2009
APPD:	Schumi			FINISH	Jamy		Sheet No.	3 from 3	