

SM05 Thru SM12

Features

- For sensitive ESD protection
- Excellent clamping capability
- Low leakage
- ESD rating of class 3(>16KV)per Human Body Mode
- For space saving application
- Fast response ,response time less than 1ns.
- Case Material: Molded Plastic. UL Flammability Classification Rating 94V-0 and MSL rating 1

Maximum Ratings

- Operating Junction & Storage Temperature: -55°C to +150°C
- Maximum Thermal Resistance: 556°C/W Junction To Ambient

Parameter	Symbol	Limits	unit
IEC61000-4-2(ESD) Air Contact		± 15 ± 8	KV
ESD Voltage per human body mode		16	KV
Power Dissipation	Pd	225	mw

Pin Configuration-Top View

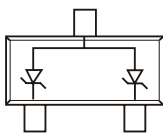

5V~12Volts ESD Protection Devices

SOT-23

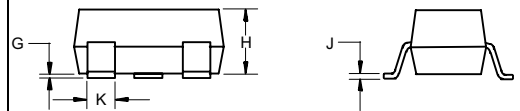
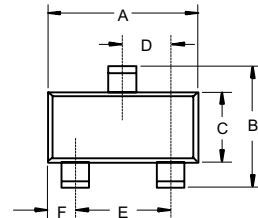

DIM	INCHES		MM		NOTE
	MIN	MAX	MIN	MAX	
A	.110	.120	2.80	3.04	
B	.083	.098	2.10	2.64	
C	.047	.055	1.20	1.40	
D	.035	.041	.89	1.03	
E	.070	.081	1.78	2.05	
F	.018	.024	.45	.60	
G	.0005	.0039	.013	.100	
H	.035	.044	.89	1.12	
J	.003	.007	.085	.180	
K	.015	.020	.37	.51	

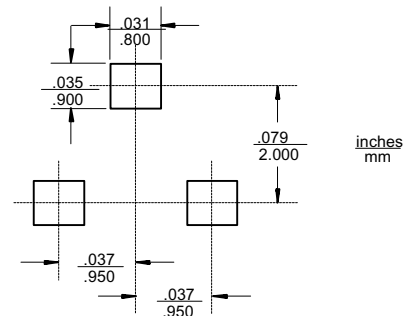

ELECTRICAL CHARACTERISTICS ($T_A = 25^\circ\text{C}$ unless otherwise noted)

UNIDIRECTIONAL (Circuit tied to Pins 1 and 3 or 2 and 3)

Symbol	Parameter
I_{PP}	Maximum Reverse Peak Pulse Current
V_C	Clamping Voltage @ I_{PP}
V_{RWM}	Working Peak Reverse Voltage
I_R	Maximum Reverse Leakage Current @ V_{RWM}
V_{BR}	Breakdown Voltage @ I_T
I_T	Test Current
I_F	Forward Current
V_F	Forward Voltage @ I_F
P_{pk}	Peak Power Dissipation
C	Capacitance @ $V_R=0$ and $f=1\text{MHz}$

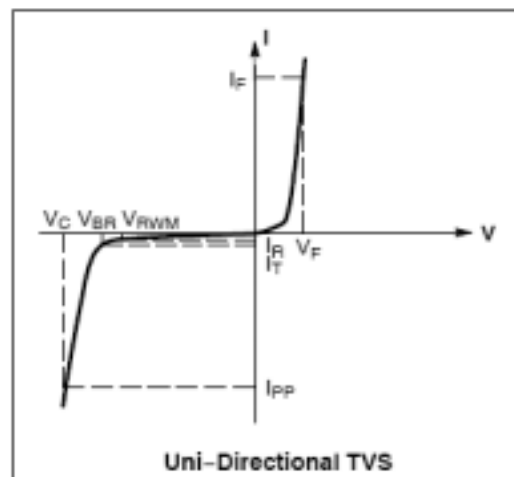

ELECTRICAL CHARACTERISTICS ($T_A = 25^\circ\text{C}$ unless otherwise noted, $V_F = 0.9\text{ V Max. @ } I_F = 10\text{mA}$ for all types)

Device	Device Marking	V_{RWM} (V)	I_R (ζ A) @ V_{RWM}	V_{BR} (V) @ I_T (Note 2)		I_T	V_C @ $I_{PP}=1\text{ A}$	Max I_{PP}^+	P_{pk}^+ (W)	C (pF) Pin 1 to 3
		Max	Max	Min	Max	mA	V	A	Max	Typ
SM05	5M	5	10	6.2	7.3	1.0	9.8	12	300	225
SM12	12M	12	1.0	13.3	15.75	1.0	19	11.2	300	95

+Surge current waveform per Figure 3

2. V_{BR} is measured with a pulse test current I_T at an ambient temperature of 25°C .

TYPICAL CHARACTERISTICS

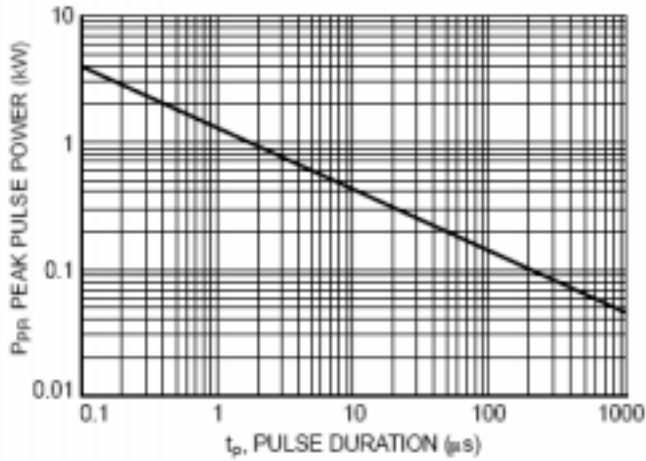

Figure 1. Non-Repetitive Peak Pulse Power versus Pulse Time

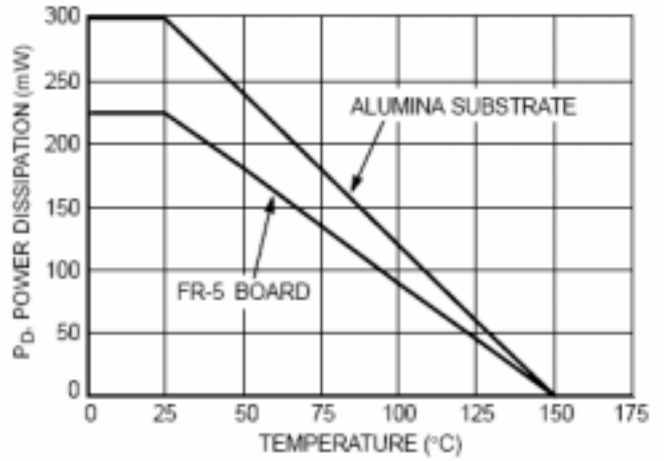

Figure 2. Steady State Power Derating Curve

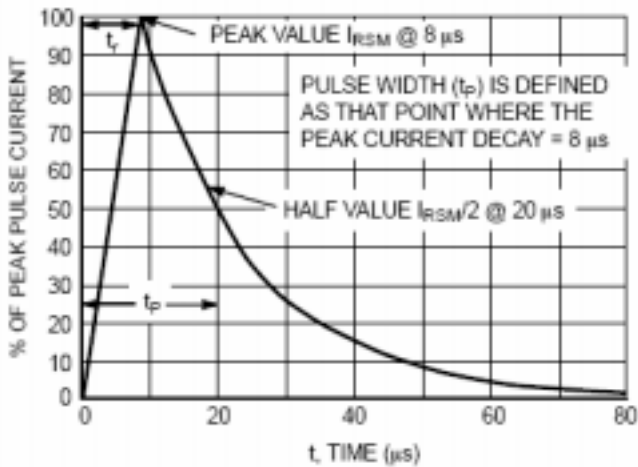

Figure 3. 8 x 20 μs Pulse Waveform

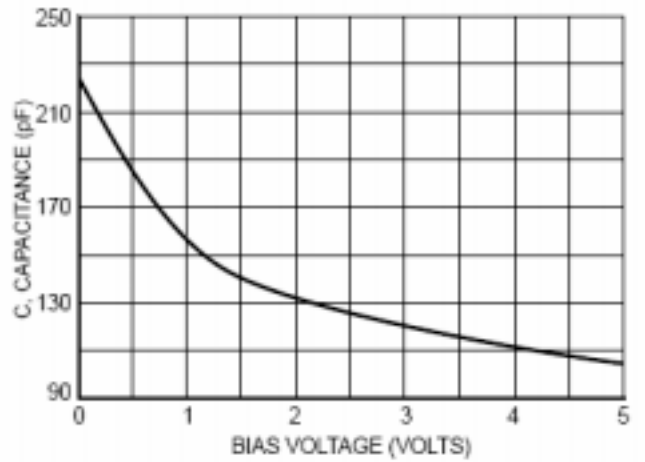

Figure 4. Typical Diode Capacitance

Ordering Information

Device	Packing
(Part Number)-TP	Tape&Reel;3Kpcs/Reel