

TM

SK52 THRU SK510

5 Amp Schottky Rectifier 20 to 100 Volts

Features

- Lead Free Finish/Rohs Compliant (Note1) ("P" Suffix designates Compliant. See ordering information)
- For Surface Mount Applications
- High Current Capability With Low Forward Voltage
- Easy Pick And Place
- High Temp Soldering: 260°C for 10 Seconds At Terminals
- Case Material: Molded Plastic. UL Flammability Classification Rating 94V-0 and MSL rating 1

Maximum Ratings

- Operating Temperature: -55°C to +150°C
- Storage Temperature: -55°C to +150°C
- Maximum Thermal Resistance; 18°C/W Junction To Lead

MCC Part Number	Device Marking	Maximum Recurrent Peak Reverse Voltage	Maximum RMS Voltage	Maximum DC Blocking Voltage
SK52	SK52	20V	14V	20V
SK53	SK53	30V	21V	30V
SK54	SK54	40V	28V	40V
SK545	SK545	45V	31.5V	45V
SK55	SK55	50V	35V	50V
SK56	SK56	60V	42V	60V
SK58	SK58	80V	56V	80V
SK510	SK510	100V	70V	100V

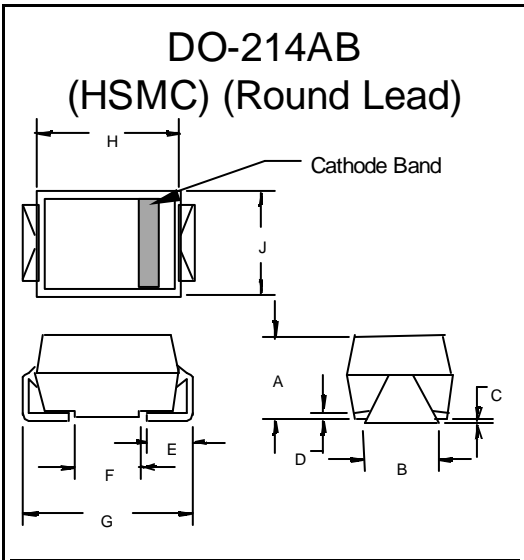

DIM	INCHES		MM		NOTE
	MIN	MAX	MIN	MAX	
A	.200	.214	5.08	5.43	
B	.177	.203	4.70	5.30	
C	.002	.005	.05	.13	
D	---	.02	---	.51	
E	.047	.056	1.20	1.42	
F	.168	.179	4.27	4.55	
G	.309	.322	7.85	8.18	
H	.239	.243	6.08	6.18	
J	.234	.240	5.95	6.10	

Electrical Characteristics @ 25°C Unless Otherwise Specified

Average Forward Current	$I_{F(AV)}$	5.0A	$T_J = 120^\circ\text{C}$
Peak Forward Surge Current	I_{FSM}	150A	8.3ms, half sine
Maximum Instantaneous Forward Voltage	V_F	.55V .75V .85V	$I_{FM} = 5.0A;$ $T_J = 25^\circ\text{C}^*$
Maximum DC Reverse Current At Rated DC Blocking Voltage	I_R	1.0mA 20mA	$T_J = 25^\circ\text{C}$ $T_J = 100^\circ\text{C}$
Typical Junction Capacitance	C_J	200pF	Measured at 1.0MHz, $V_R=4.0V$

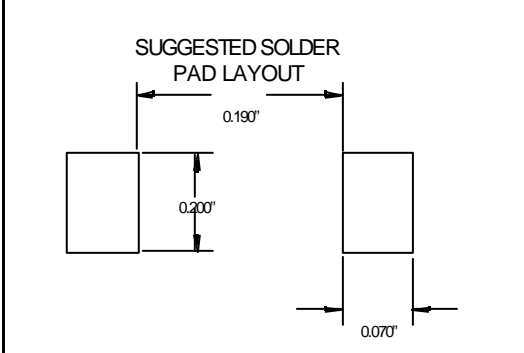

*Pulse test: Pulse width 200 usec, Duty cycle 2%
Note: 1. High Temperature Solder Exemptions Applied, see EU Directive Annex 7.

SK52 thru SK510

Figure 1
Typical Forward Characteristics

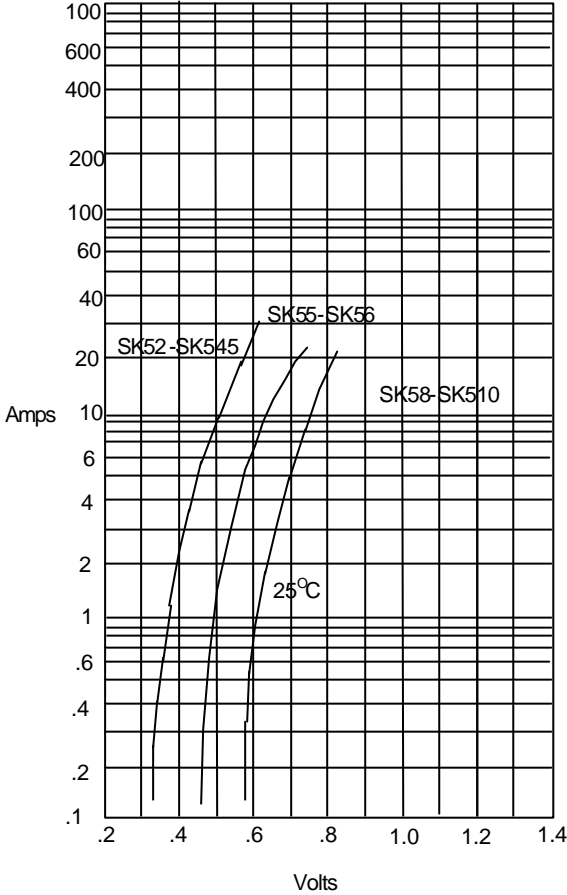

Instantaneous Forward Current - Amperes versus
Instantaneous Forward Voltage - Volts

Figure 2
Forward Derating Curve

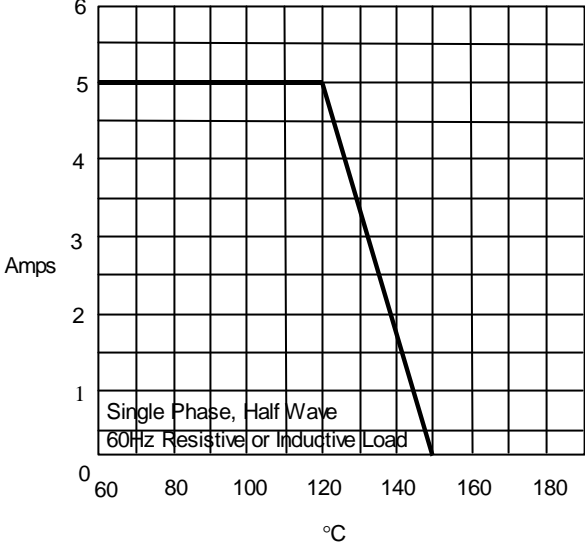

Average Forward Rectified Current - Amperes versus
Ambient Temperature - °C

Figure 3
Junction Capacitance

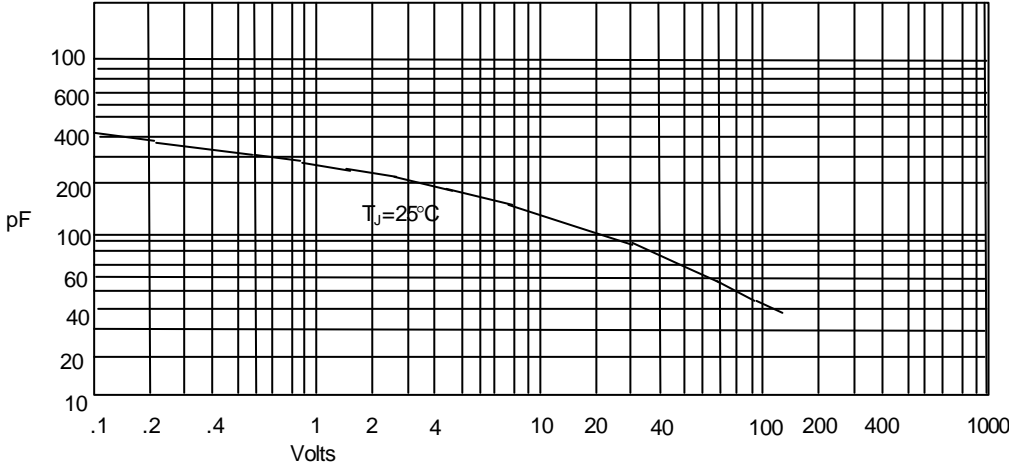

Junction Capacitance - pF versus
Reverse Voltage - Volts

Figure 4
Typical Reverse Characteristics

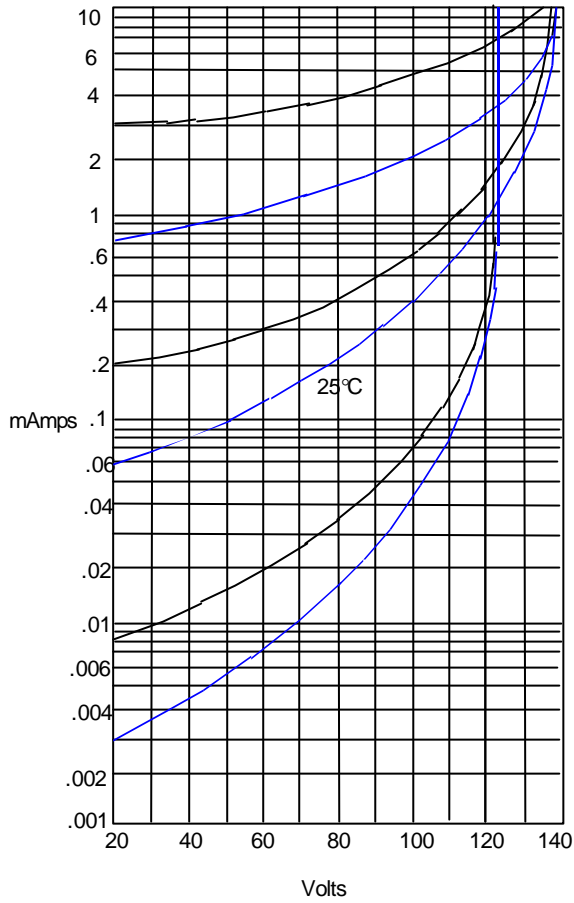

Instantaneous Reverse Leakage Current - MicroAmperes *versus*
Percent Of Rated Peak Reverse Voltage - Volts

Figure 5
Peak Forward Surge Current

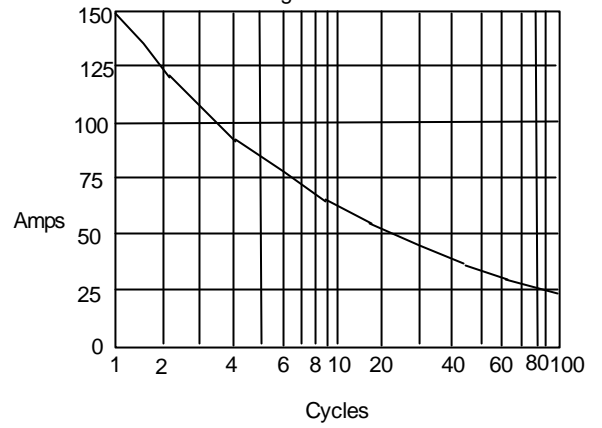

Peak Forward Surge Current - Amperes *versus*
Number Of Cycles At 60Hz - Cycles

SK52-SK545	—
SK55-SK510	—

Ordering Information

Device	Packing
(Part Number)-TP	Tape&Reel;1.5Kpcs/Reel