

™

BAT54T THRU BAT54ST

Features

- Ultra-Small Surface Mount Package
- Low Forward Voltage Drop
- Fast Switching
- PN Junction Guard Ring for Transient and ESD Protection
- Case Material: Molded Plastic. UL Flammability Classification Rating 94V-0 and MSL Rating 1

MCC Part Number	Device Marking	Type	Pin Configuration
BAT54T	L1	Single	Figure 1
BAT54AT	L2	Dual	Figure 2
BAT54CT	L3	Dual	Figure 3
BAT54ST	L4	Dual	Figure 4

Maximum Ratings

DC Blocking Voltage	V_R	30V
Average Rectified Output Current	I_O	200mA
Repetitive Peak Forward Current	I_{FRM}	300mA
Non-Repetitive Peak Forward Current $t < 1s$	I_{FSM}	600mA
Total Power Dissipation @ $T_A = 25^\circ C$	P_D	150mW
Storage Temperature Range	T_{stg}	$-65^\circ C$ to $125^\circ C$
Junction Temperature	T_j	$-65^\circ C$ to $125^\circ C$
Thermal Resistance Junction to Ambient	$R_{\theta JA}$	667°C/W

Electrical Characteristics @ 25°C Unless Otherwise Specified

Ratings	Symbol	Max.	Notes
Forward Voltage	V_F	240mV	$I_F = 0.1mA$
		320mV	$I_F = 1mA$
		400mV	$I_F = 10mA$
		500mV	$I_F = 30mA$
		1000mV	$I_F = 100mA$
Reverse Current	I_R	2 μA	$V_R = 25V$
Reverse Breakdown Voltage	$V_{(BR)}$	>30V	$I_R = 100\mu A$
Total Capacitance	C_T	10pF	Measured at 1.0MHz, $V_R = 1.0V$
Reverse Recovery Time	t_{rr}	5nS	$I_F = 10mA$; $I_R = 10mA \sim 1.0mA$, $R_L = 100 \Omega$

150mWatt, 30Volt
Schottky Barrier Diode

SOT-523

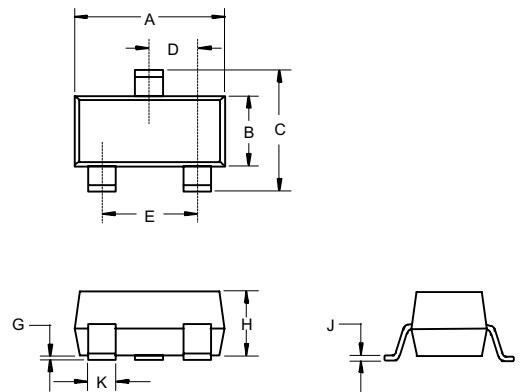

DIM	INCHES		MM		NOTE
	MIN	MAX	MIN	MAX	
A	.059	.067	1.50	1.70	
B	.030	.033	0.75	0.85	
C	.057	.069	1.45	1.75	
D	.020 Nominal		0.50 Nominal		
E	.035	.043	0.90	1.10	
G	.000	.004	.000	.100	
H	.028	.031	.70	0.80	
J	.004	.008	.100	.200	
K	.010	.014	.25	.35	

BAT54T thru BAT54ST

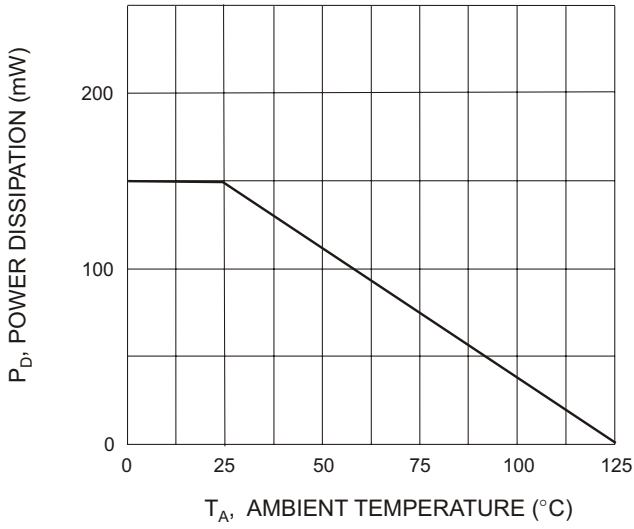

Fig. 1 Power Derating Curve

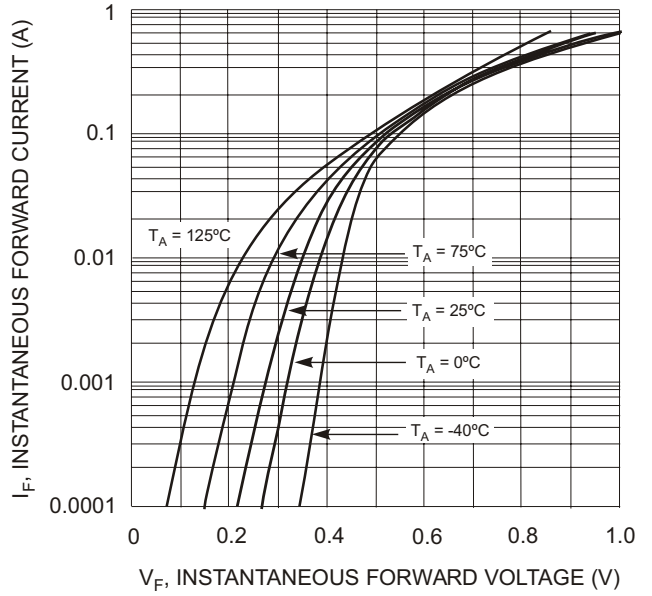

Fig. 2 Forward Characteristics

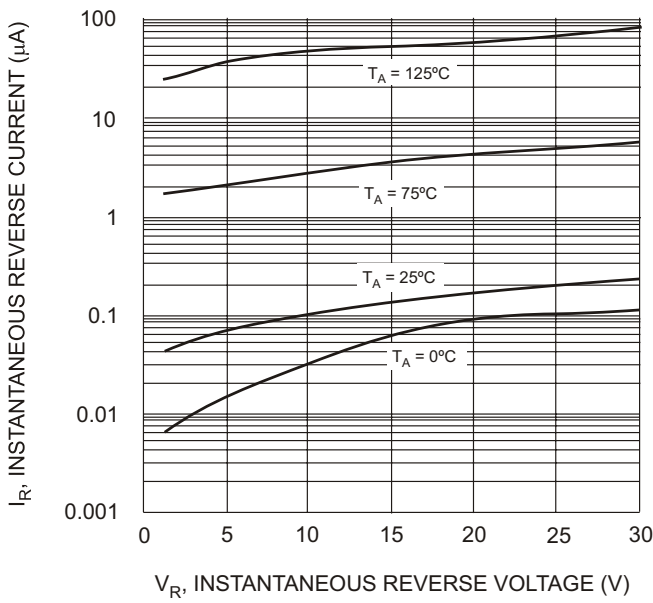

Fig. 3 Typical Reverse Characteristics

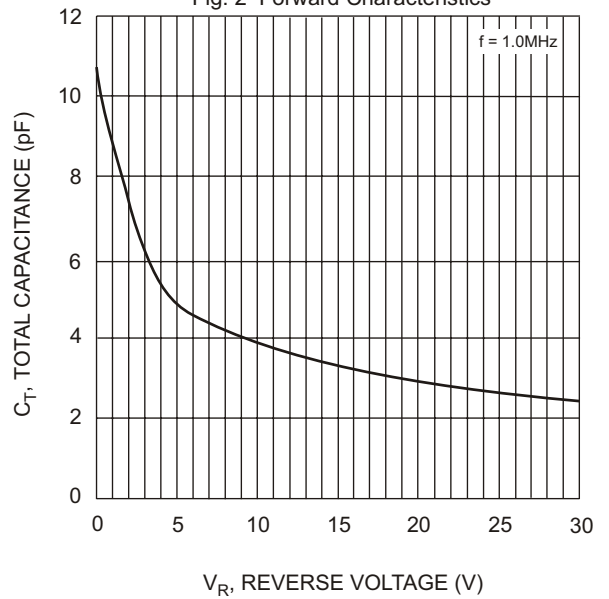

Fig. 4 Typical Capacitance vs. Reverse Voltage

Pin Configuration - Top View

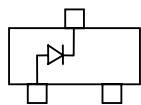

Figure 1

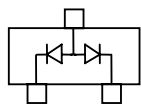

Figure 2

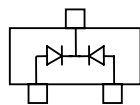

Figure 3

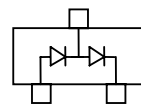

Figure 4

Ordering Information

Device	Packing
(Part Number)-TP	Tape&Reel;3Kpcs/Reel
