

FR3AB THRU FR3MB

Features

- Easy Pick And Place
- High Temp Soldering: 260°C for 10 Seconds At Terminals
- Fast Recovery Times For High Efficiency

Maximum Ratings

- Operating Temperature: -55°C to +150°C
- Storage Temperature: -55°C to +150°C
- Maximum Thermal Resistance; 10°C/W Junction To Lead

MCC Catalog Number	Device Marking	Maximum Recurrent Peak Reverse Voltage	Maximum RMS Voltage	Maximum DC Blocking Voltage
FR3AB	FR3AB	50V	35V	50V
FR3BB	FR3BB	100V	70V	100V
FR3DB	FR3DB	200V	140V	200V
FR3GB	FR3GB	400V	280V	400V
FR3JB	FR3JB	600V	420V	600V
FR3KB	FR3KB	800V	560V	800V
FR3MB	FR3MB	1000V	700V	1000V

Electrical Characteristics @ 25°C Unless Otherwise Specified

Average Forward Current	$I_{F(AV)}$	3.0A	$T_J = 120^\circ\text{C}$
Peak Forward Surge Current	I_{FSM}	100A	8.3ms, half sine
Maximum Instantaneous Forward Voltage	V_F	1.30V	$I_{FM} = 3.0\text{A}; T_J = 25^\circ\text{C}^*$
Maximum DC Reverse Current At Rated DC Blocking Voltage	I_R	10 μA 250 μA	$T_J = 25^\circ\text{C}$ $T_J = 100^\circ\text{C}$
Maximum Reverse Recovery Time	T_{rr}	150ns 250ns 500ns	$I_F=0.5\text{A}, I_R=1.0\text{A}, I_{rr}=0.25\text{A}$
Typical Junction Capacitance	C_J	80pF	Measured at 1.0MHz, $V_R=4.0\text{V}$

*Pulse test: Pulse width 200 μsec , Duty cycle 2%

3 Amp Fast Recovery Silicon Rectifier 50 to 1000 Volts

DO-214AA (SMB) (LEAD FRAME)

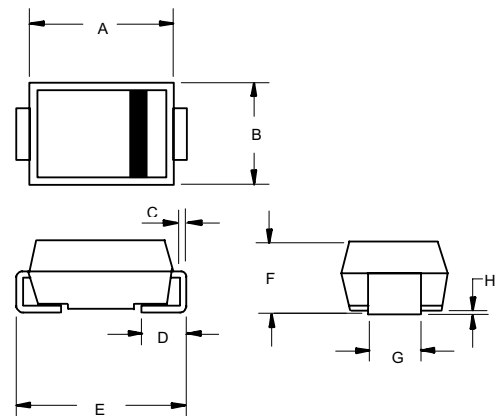

DIM	DIMENSIONS				NOTE
	INCHES		MM		
	MIN	MAX	MIN	MAX	
A	.160	.185	4.06	4.70	
B	.130	.155	3.30	3.94	
C	.006	.012	0.15	0.31	
D	.030	.060	0.76	1.52	
E	.200	.220	5.08	5.59	
F	.079	.103	2.01	2.62	
G	.075	.087	1.91	2.21	
H	.002	.008	0.05	0.203	

SUGGESTED SOLDER PAD LAYOUT

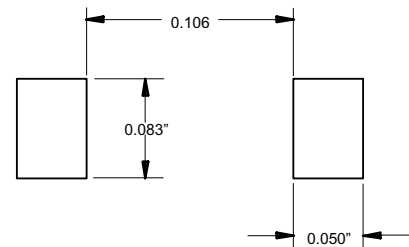

FR3AB thru FR3MB

Figure 1
Typical Forward Characteristics

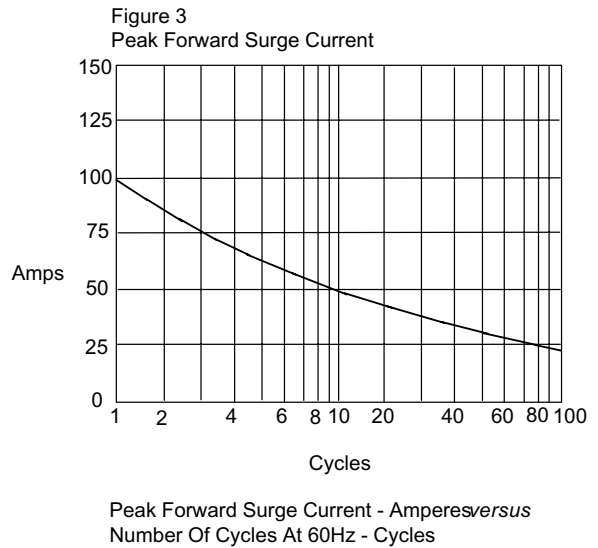
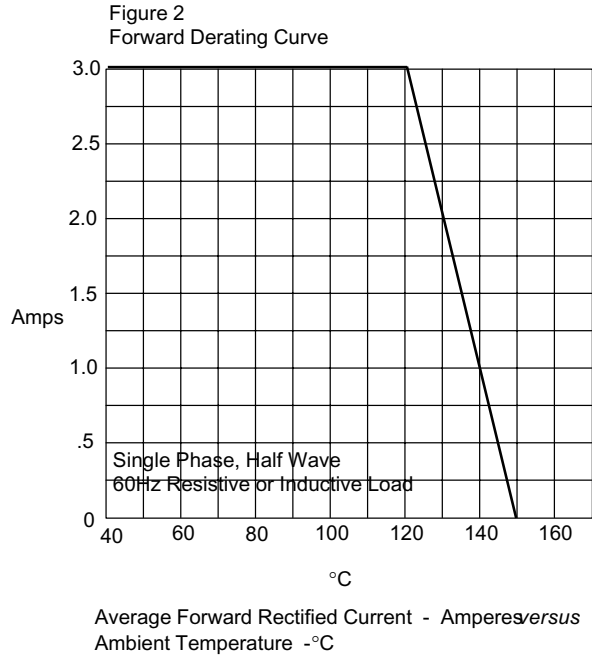
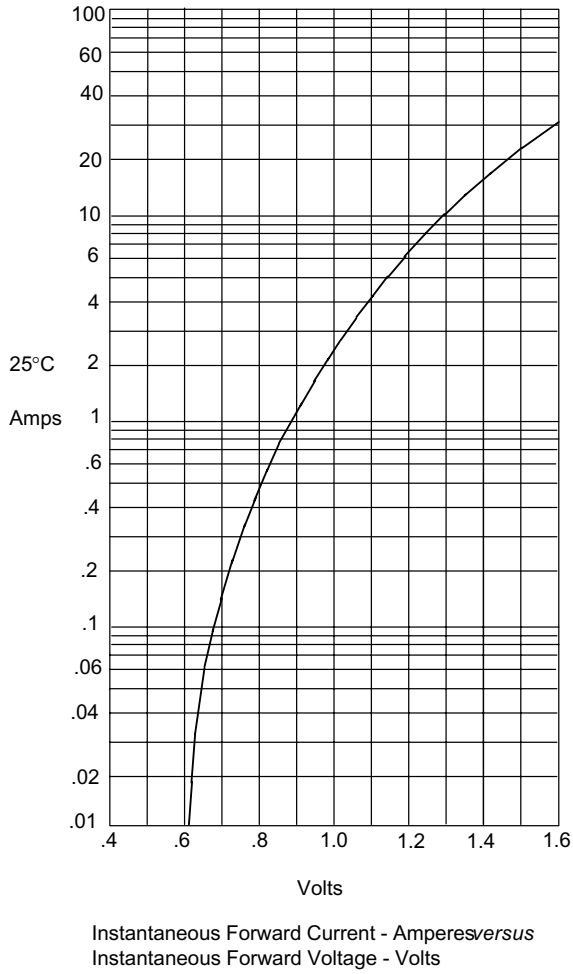

FR3AB thru FR3MB

Figure 4
Typical Reverse Characteristics

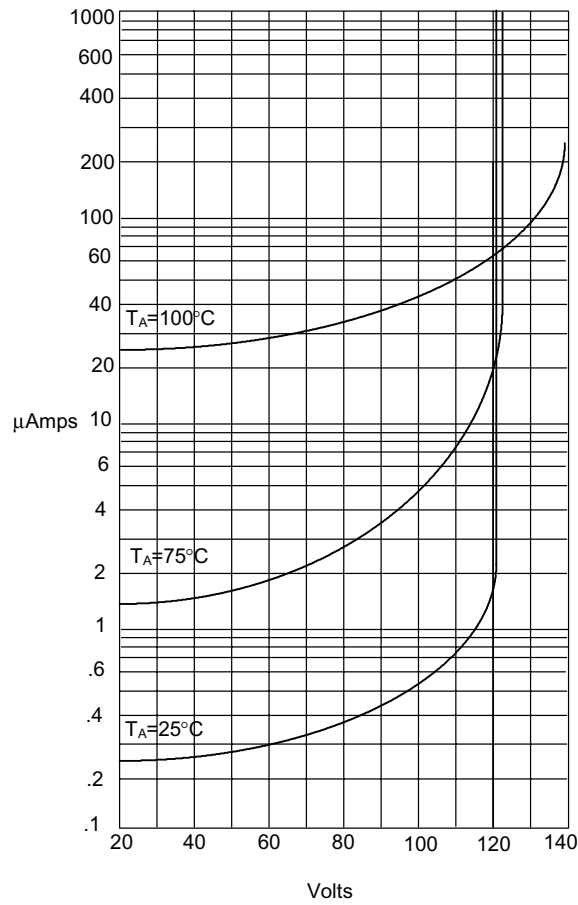

Instantaneous Reverse Leakage Current - MicroAmperes versus Percent Of Rated Peak Reverse Voltage - Volts

Figure 5
Reverse Recovery Time Characteristic And Test Circuit Diagram

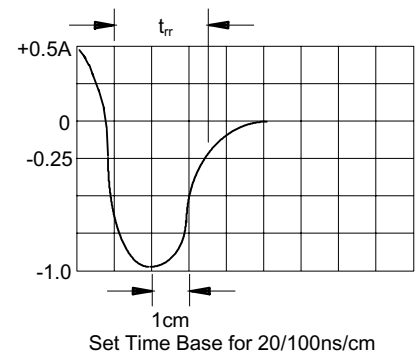
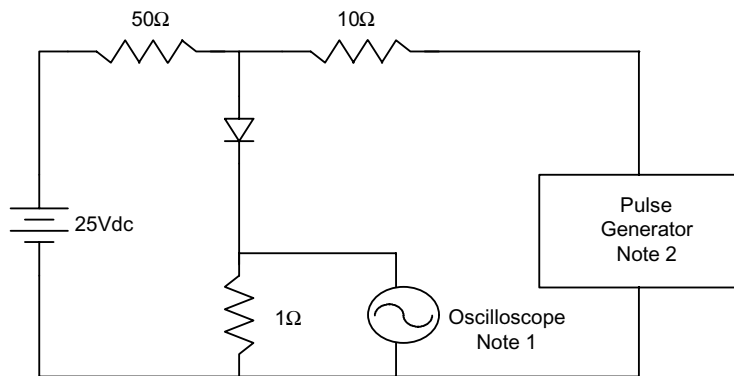

- Notes:
1. Rise Time = 7ns max.
Input impedance = 1 megohm, 22pF
 2. Rise Time = 10ns max.
Source impedance = 50 ohms
 3. Resistors are non-inductive

Ordering Information

Device	Packing
(Part Number)-TP	Tape&Reel;3Kpcs/Reel

▪

▪