

EDCON-COMPONENTS

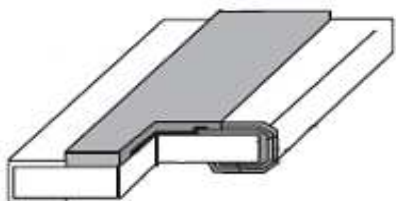

Thick Film Chip Resistor

Performance Specifications

Temperature Coefficient	1Ω ~ 10Ω +/-200PPM/°C 11Ω ~ 100Ω +/-100PPM/°C >100Ω +/-100PPM/°C
Short Time Overload	5% +/-2,0% +0,1Ωmax.
Insulation Resistance:	Min 1000Mega Ω
Dielectric Withstanding Voltage	No evidence of Flashover, mechanical damage, arcing or insulation breakdown
Terminal Bending	./-(1,0% +0,05Ω) max.
Soldering Heat	Resistance change rate is +/--(1% + 0,05Ω)max.
Solderability	Min. 95% coverage
Temperature Cycling	./-5% : +/--(1,0% + 0,05Ω) max.
Humidity (Steady State)	./-5% : +/--(3,0% + 0,01Ω) max.
Load Life in Humidity	./-5% : +/--(3,0% + 0,01Ω) max.
Load Life	./-5% : +/--(3,0% + 0,01Ω) max.
Standard Operating Temperature	. -55°C ~ +155°C
Tolerance Informations	E24 Series 2% / 5% / 10%

Features

Small Size and light weight
Suitable for both flow and reflow soldering
Reduction of assembly costs

Dearting Curve

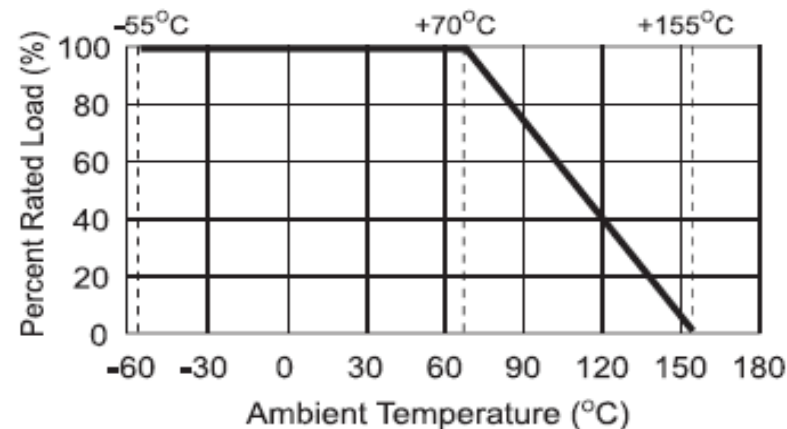

Test Methods of JIS 5201-1

Flame Retardant: (JIS 5201-1 7.12)	Resistor shall resist flaming or arcing when overloaded up to 16 times RCWV or max. RCWV whichever is lesser. Lit burner and adjust to procedure a blue flame 38mm in height & a max. 127mm flame from the burner tube. Resistor is supported from ist lead at 45°C from the horizontal so that the lower end of resistor is on the top of blue flame. The resistor is placed on this test flame for 15sec. Keep cool for 15sec. Repeat this procedure for 5 times.
------------------------------------	---------------------------------------------------------------------------------------------------------------------------------------------------------------------------------------------------------------------------------------------------------------------------------------------------------------------------------------------------------------------------------------------------------------------------------------------------------------------

**CHIP Resistor Size 0612
Tol. 1%**

Part No.: **X30031**

DRW:	Jason	CHKD	Wilson	MATL:	Wilson	TOLERANCE	Mason	DATE	10.04.2009	Customer:
APPD:	Schumi			FINISH	Jamy		Sheet No.	1 from 6		

EDCON-COMPONENTS

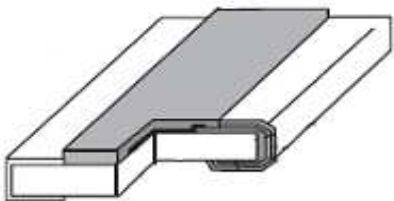

Test Method of JIS C 5201-1 Thick Film Chip Resistor

Temperature Coefficient (JIS C 5201-1 4.8)	Natural Resistance change per temperature degree centigrade R1: Resistance value at room temperature (t1) R2: Resistance value at room temperature plus 100°C (t2) Test pattern: Room temperature (t1), Room temperature +100°C (t2)
Short time overload (JIS C5201-1 4.13)	Permanent resistance change after application of a potential of 2,5 times RCWV for 5sec.
Insulation resistance (JIS-C 5201-1 4.6)	Apply 500VDC between protective coating and termination for 1min. Then measure 100V DC specially for resistor network.
Dielectric Withstanding Voltage (Voltage proof) (JIS-C 5201-1 4.7)	Resistors shall be clamped in the method use a metal foil shall be wrapped closely around the body of the resistor. After that shall be tested at AC potential respectively specified in the given list of each product type for 60 +10/0 secs. For cement fixed resistors, the testing voltage is 1000Volts. For Chip resistors, testing voltage is 500 Volts.
Pulse Overload (JIS-5202 5.8)	Resistance change after 10.000 cycles (1sec "ON", 25sec "OFF") at 4times of RCWV or maximum overload:
Terminal Strength (JIS-5201-1 4.16)	Direct Load: Resistance to a 2,5Kgs.. Direct load for 10sec in a direction of the longitudinal axis of terminals leads. Twist Test. Terminal leads shall be bent trough 90° at the point of about 6mm grom the body of the resistor and shall be rotated trough 360° about the original axis of the bent terminal in alternating direction for a total of 3 rotations.
Terminal Strength (JIS-5201-1 4.16)	(Applicable for Resistor Network) Tensile: 1KG., 30sec., Bending: 500g, 2 times
Terminal Strength (JIS-5201-1 4.33)	(Applicable for CHIP Resistors) Twist of the test board: X/Y = 3/90mm for 10sec.
Vibration (JIS-5201-1 4.22)	X, Y, Z, each direction 2 hours, 10~55 ~ 10Hz / min. All amplitude 1,5mm
Soldering Heat (JISC 5201-1 4.18)	(Applicable for Chip Resistors) Dip the resistor into a solder bath having a temper. of 260 +/-5°C and hold it for 10 +/-1sec. Lead(Pb) free temp.: 260 +/-3°C, 5 + 1/-0sec.
Resistance to Soldering Heat (JISC 5201-1 4.18)	Permanent Resistance change when leads immersed to a point 2.0 ~ 2,5mm from the body in 350 +/-10°C solder for 3-4 sec. Lead (Pb) free temper.: 260 +/-3°C, 5 + 1/-0sec.
Solderability (JISC 5201-1 4.17)	The area covered with a new, smooth clean , shiny and continious surface free from concentrated pinholes. Test temperature of solder: 235 +/-5°C; Dwell time in solder: 3~5sec. Lead (PB) free temper.: 245 +/-3°C; Dwell time in solder: 2~3sec.
Resistance to solvent (JIS5201-1 4.29 /4.30)	Specimens shall be immersed in a bath of alcohol completely for 3min. Using ultrasonic test equipment.
Thermal Shock (JIOS 5201-1 4.21)	(Applicable fir Resistor Network) Load V, rom temperature, 30min. Unload, -55°C, 15min. Over 2 hours in room temp. Before measuring.
Rapid Change Temperature: (JIS 5201-1 4.19)	Resistance change after continious 5cycles for duty cycle specified below: Step1: 30min.at -55 +/-3°C / Step2: 10~15min. At room tempeprature. Step3: 30min. At 155 +/-2°C. Step4: 10~15min. At room tempeprature.
Humidity (Steady Style) (JIS 5201-1 4.24)	Temporary resistance change after 240hours exposure in a humidity test chamber controlled at 40 +/-2°C and 50-95% relative humidity.
Load Life in Humidity (JIS 5201-1 7.9)	Resistance change after 1000hrs. (1,5hrs "ON", 0,5hrs "OFF" at RCWV or max. RCWV whichever is lesser in a humidity test chamber controlled at 40 +/-2°C and 90 ~ 95% relative humidity.
Load Life (JIS 5201-1 25.1)	Permanent Resistance change after 1000hours operating at RCWV or max. RCWV whichever is lesser, with duty cycles of 1,5hours "ON" 0,5hours "OFF" at 70 +/-2°C ambient.

**CHIP Resistor Size 0612
Tol. 1%**

Part No.: **X30031**

DRW:	Jason	CHKD	Wilson	MATL:	Wilson	TOLERANCE	Mason	DATE	10.04.2009	Customer:
APPD:	Schumi			FINISH	Jamy		Sheet No.	2 from 6		

EDCON-COMPONENTS

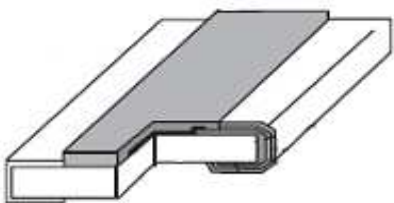

Thick Film Chip Resistor

Technical Dimensions

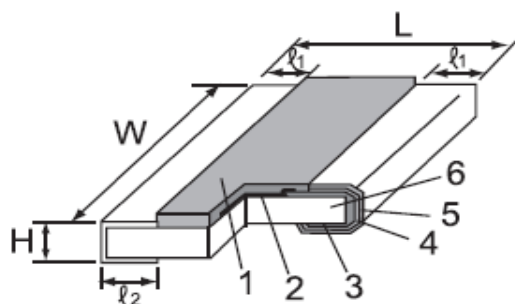

1. Protective Layer
2. Resistive element
3. Termination (Inner) Ni/Cr
4. Termination (Middle) Ni/Cr
5. Termination (Outer) Ni/Cr
6. High Pur Alumina Subst.

Physical Structure

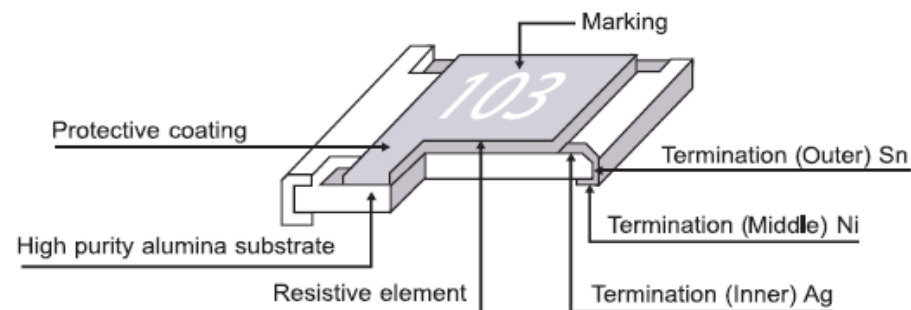

Size	Power Rating at 70°C	Max. Working Voltage	Max. Overload Voltage	Dielectric Withstanding Voltage	Tolerance %	Resistance Range	Dimensions (mm)				
							L	W	H	l1	l2
0612 (1632)	1/2W	200V	400V	500V	±1%	10Ω ~ 1MΩ	1,60 ±0,15	3,20 ±0,15	0,55 ±0,10	0,45 ±0,20	0,30 ±0,20

Range Table Row E24

Ω	10	11	12	13	15	16	18	20	22	24	27	30	33	36	39	43	47	51	56	62	68	75	82	91
Ω	100	110	120	130	150	160	180	200	220	240	270	300	330	360	390	430	470	510	560	620	680	750	820	910
KΩ	1,0	1,1	1,2	1,3	1,5	1,6	1,8	2,0	2,2	2,4	2,7	3,0	3,3	3,6	3,9	4,3	4,7	5,1	5,6	6,2	6,8	7,5	8,2	9,1
KΩ	10	11	12	13	15	16	18	20	22	24	27	30	33	36	39	43	47	51	56	62	68	75	82	91
KΩ	100	110	120	130	150	160	180	200	220	240	270	300	330	360	390	430	470	510	560	620	680	750	820	910
MΩ	1,0																							

**CHIP Resistor Size 0612
Tol. 1%**

Part No.: **X30031**

DRW:	Jason	CHKD	Wilson	MATL:	Wilson	TOLERANCE	Mason	DATE	10.04.2009
APPD:	Schumi			FINISH	Jamy		Sheet No.		3 from 6

Customer:

EDCON-COMPONENTS

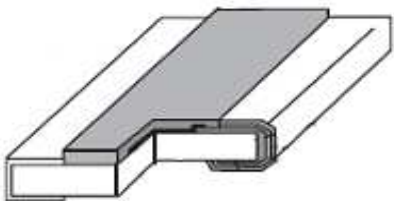

Thick Film Chip Resistor Body Marking

1 digit & 2 & 3 digit are significant figures of the resistance
4 digit indicates number of zeros

Tol. 1%
1Ω ~ 9,9Ω
3R30 = 3,30Ω

Tol. 1%
10Ω ~ 1MΩ
2432 = 24,3KΩ

CHIP Resistor Size 0612	
Tol. 1%	
Part No.:	X30031
Customer:	

DRW:	Jason	CHKD	Wilson	MATL:	Wilson	TOLERANCE	Mason	DATE	10.04.2009
APPD:	Schumi			FINISH	Jamy		Sheet No.	4 from 6	

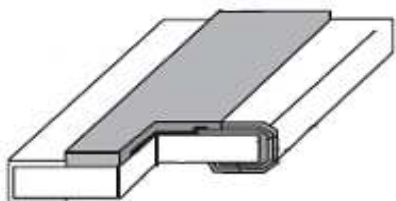

Thick Film Chip Resistor Soldering Profile Curve

Classification Reflow Profile (JEDEC J-STD-020C)



CHIP Resistor Size 0612	
Tol. 1%	
Part No.:	X30031
Customer:	

DRW:	Jason	CHKD	Wilson	MATL:	Wilson	TOLERANCE	Mason	DATE	10.04.2009
APPD:	Schumi			FINISH	Jamy		Sheet No.		5 from 6

EDCON-COMPONENTS

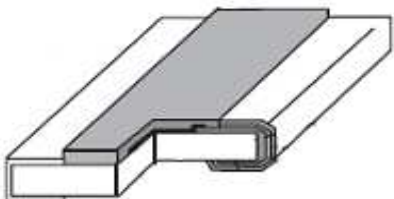

Thick Film Chip Resistor Ordering Information Table

Ordering Informations

Serie	Range Table	Tolerance	T.C.R	ROHS	P-Quantity					
X30031	100	F	A0	R	T502					

xxx= look Range Table	F= 1%	A0= +/- 100ppm	R= ROHS Conform
			N= NON ROHS

T502= Tape
Reel 5000PCS

T103= Tape
Reel 10000PCS

**CHIP Resistor Size 0612
Tol. 1%**

Part No.: **X30031**

DRW:	Jason	CHKD	Wilson	MATL:	Wilson	TOLERANCE	Mason	DATE	10.04.2009
APPD:	Schumi			FINISH	Jamy		Sheet No.		6 from 6

Customer: