

EDCON-COMPONENTS

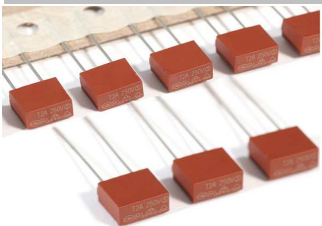

Technical Description

Standard: IEC 60127, GB 9364
Operating Temperature: . -55°C ~ + 125°C
Storage Temperature: . -55°C ~ + 85°C
Solderability: 245°C ± 5°C 5sec ± 0,5sec
Resistance to Soldering Head: 260°C, 10s. Max.

Electrical Characteristics:
 2,1In Max. 2 minutes
 2,75In Min 400ms
 4In Max. 10 seconds
 Min. 150ms
 10In Max. 3 seconds
 Min. 20ms
 Max. 150ms

Interrupting Capacity
 CCC/ CQC /SEMKO / VDE / UR / BSI 35A or 10In 250VAC whichever is greater
 TÜV 130A 250VAC (315mA ~ 10A)

Range Code: 4A00

Range: 4A00= 4,00A

TAPE-Box-Packing

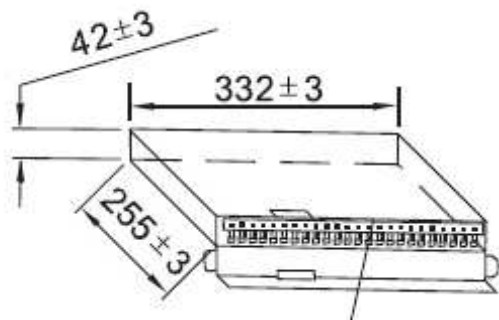

Approvals 250VAC

CCC	
CQC	YES
SEMKO	YES
VDE	YES
URus	YES
BSI	YES
PSE	YES
KC	YES
TÜV	YES

Drawing (mm)

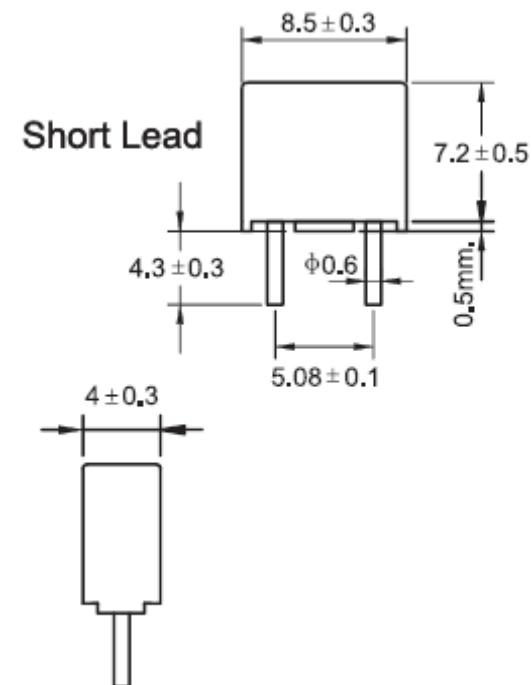

8,5mm Rectangular Fuse Time Lag

Part No.: R23004

DRW:	Jason	CHKD	Wilson	MATL:	Wilson	TOLERANCE	Mason	DATE	11.05.2014
APPD:	Schumi			FINISH	Jamy		Sheet No.		1 from 4

Customer:

EDCON-COMPONENTS

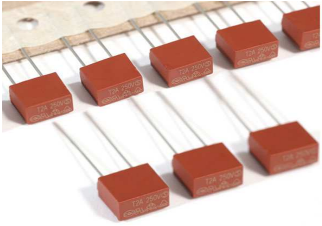

Current Characteristics Curve

Tape/Box Packing

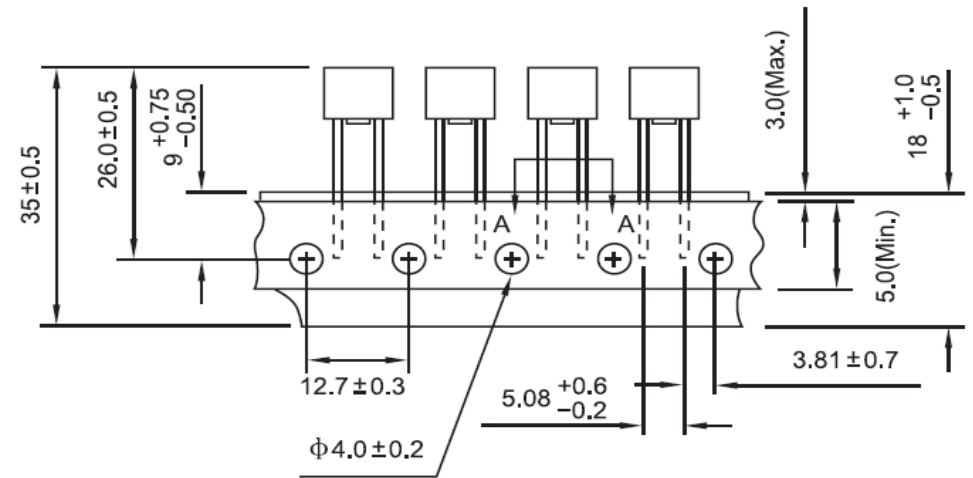
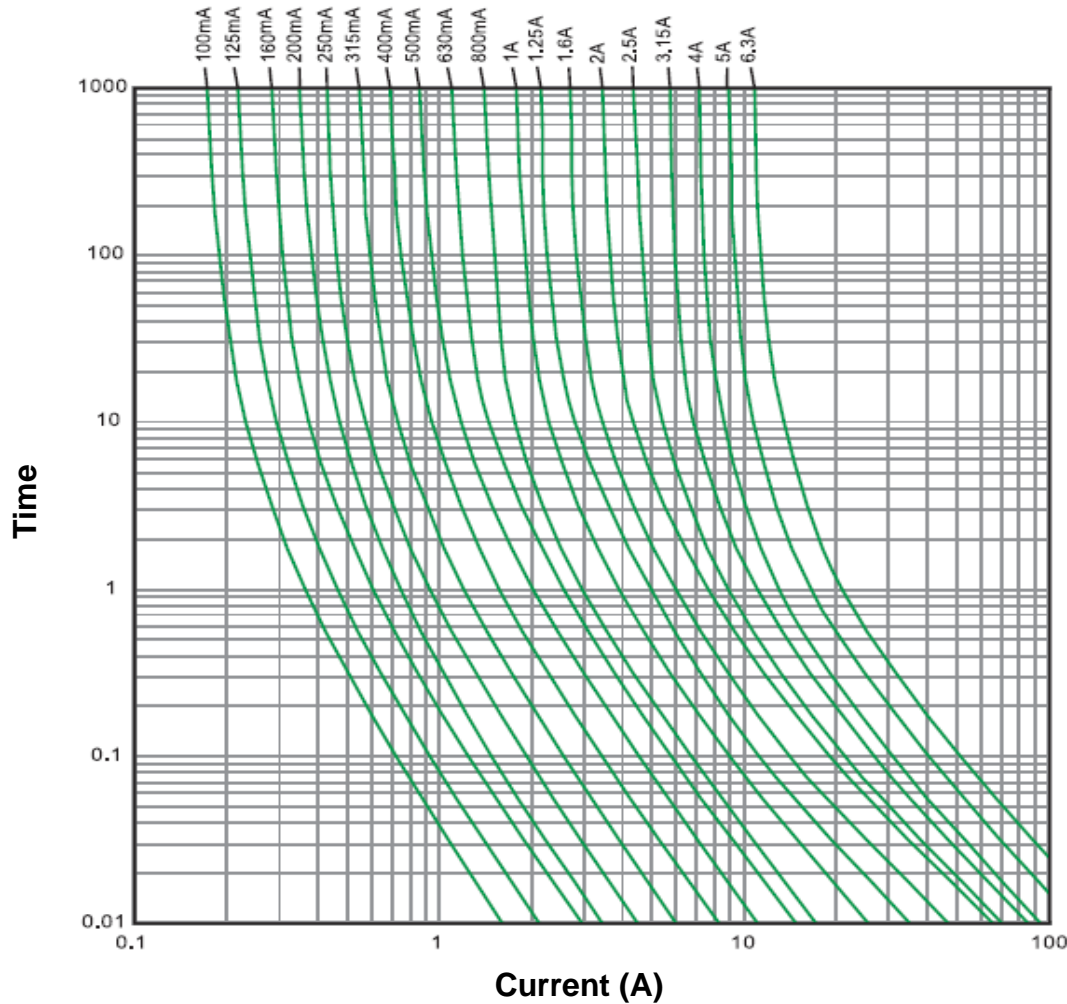

8,5mm Rectangular Fuse Time Lag

Part No.: **R23004**

DRW:	Jason	CHKD	Wilson	MATL:	Wilson	TOLERANCE	Mason	DATE	11.05.2014
APPD:	Schumi			FINISH	Jamy		Sheet No.	2 from 4	Customer:

www.edcon-components.com

email: info@edcon-components.com

EDCON-COMPONENTS

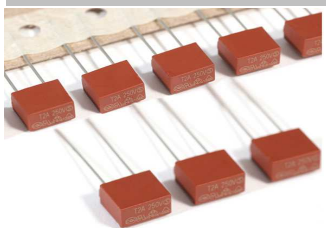

Ordering Informations

Serie	Range Code	Voltage	ROHS	Packing						
-------	------------	---------	------	---------	--	--	--	--	--	--

R23004	-	4A00	A	R	BL					
---------------	---	-------------	----------	----------	-----------	--	--	--	--	--

4A00= 4,00A	A= 250VAC	R= ROHS Conform	BL Bulk-Ware long Lead
			B4= Bulk-Ware lead length 4mm
			TR= Tape Reel 1000PCS standard

8,5mm Rectangular Fuse Time Lag
Part No.: R23004
Customer:

DRW:	Jason	CHKD	Wilson	MATL:	Wilson	TOLERANCE	Mason	DATE	11.05.2014
APPD:	Schumi			FINISH	Jamy		Sheet No.		3 from 4

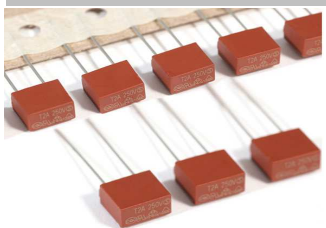

Soldering Profile Curve

Classification Reflow Profile (JEDEC J-STD-020C)



8,5mm Rectangular Fuse Time Lag

Part No.: **R23004**

DRW:	Jason	CHKD	Wilson	MATL:	Wilson	TOLERANCE	Mason	DATE	11.05.2014
APPD:	Schumi			FINISH	Jamy		Sheet No.	4 from 4	Customer: