

# EDCON-COMPONENTS

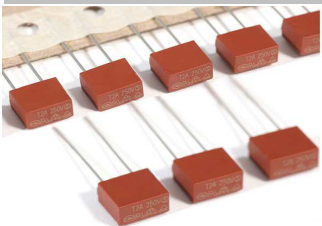

## Technical Discription

**Standard:** IEC 60127, GB 9364  
**Operating Temperature:** . -55°C ~ + 125°C  
**Storage Temperature:** . -55°C ~ + 85°C  
**Solderability:** 245°C ± 5°C 5sec ± 0,5sec  
**Resistance to Soldering Head:** 260°C, 10s. Max.

**Electrical Characteristics:**  
 2,1In Max. 2 minutes  
 2,75In Min 400ms  
 4In Max. 10 seconds  
 Min. 150ms  
 Max. 3 seconds  
 10In Min. 20ms  
 Max. 150ms

**Interrupting Capacity**  
 CCC/ CQC /SEMKO / VDE / UR / BSI 35A or 10In 250VAC whichever is greater  
 TÜV 130A 250VAC (315mA ~ 10A)

**Range Code:** 2A00

**Range:** 2A00= 2,00A

### TAPE-Box-Packing

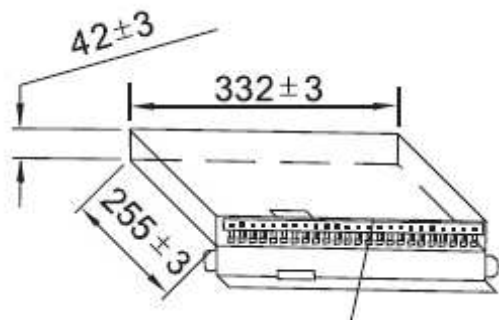

## Drawing (mm)

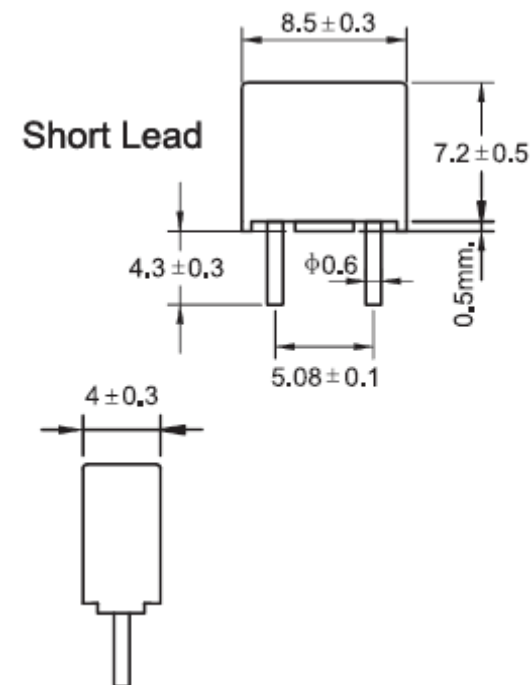

### Approvals 250VAC

CCC	
CQC	YES
SEMKO	YES
VDE	YES
URus	YES
BSI	YES
PSE	YES
KC	YES
TÜV	YES

**8,5mm Rectangular Fuse Time Lag**

Part No.: R23004

DRW:	Jason	CHKD	Wilson	MATL:	Wilson	TOLERANCE	Mason	DATE	11.05.2014
APPD:	Schumi			FINISH	Jamy		Sheet No.		1 from 4

Customer:

# EDCON-COMPONENTS

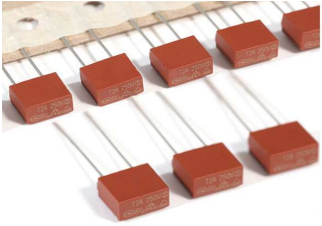

**Current Characteristics Curve**

**Tape/Box Packing**

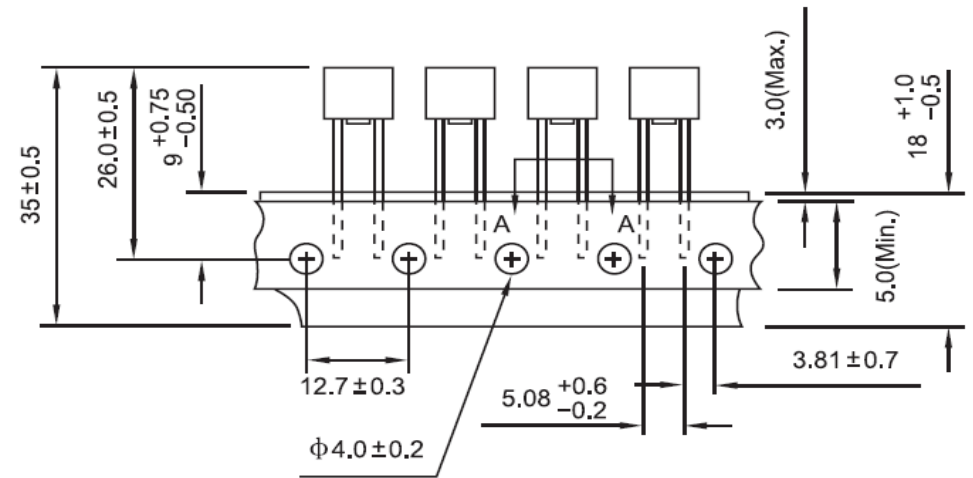
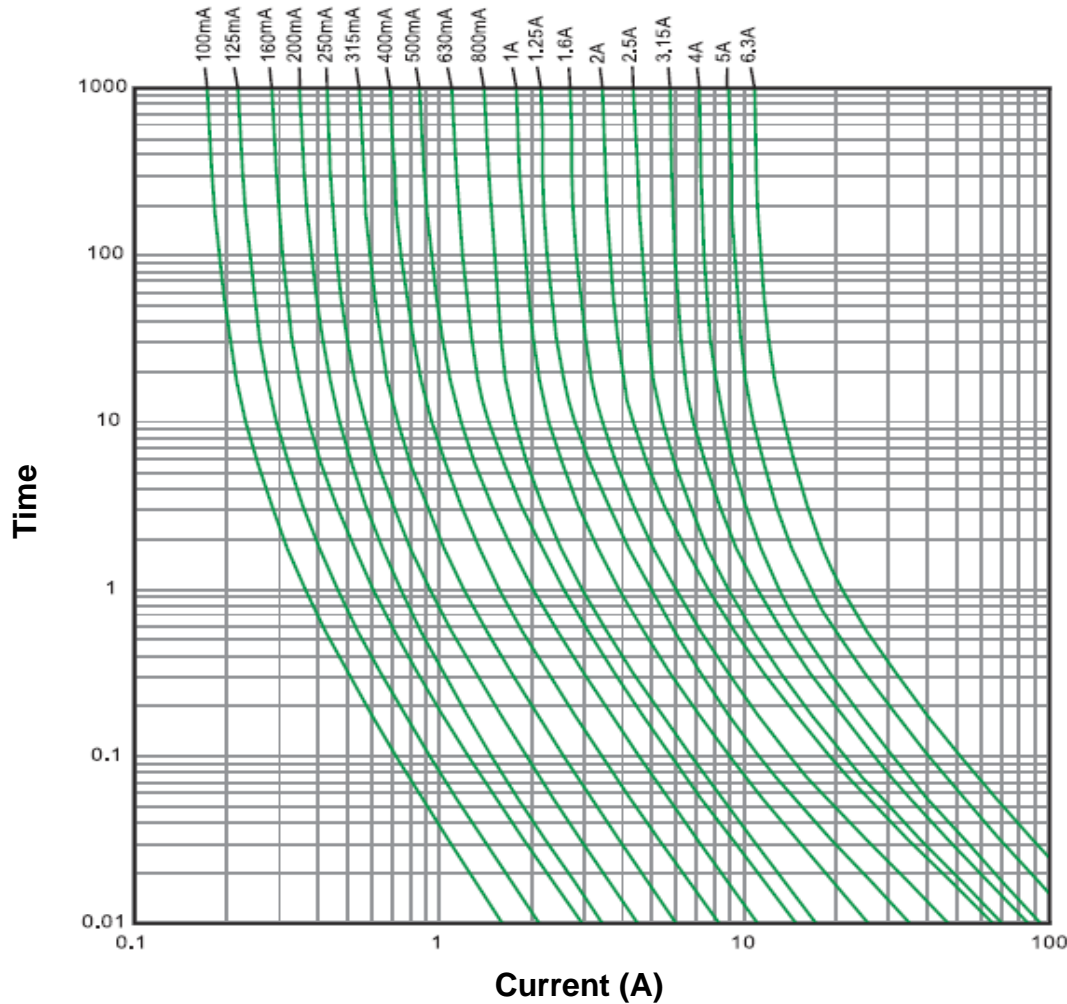

<b>8,5mm Rectangular Fuse Time Lag</b>	
Part No.:	<b>R23004</b>
Customer:	

DRW:	Jason	CHKD	Wilson	MATL:	Wilson	TOLERANCE	Mason	DATE	11.05.2014
APPD:	Schumi			FINISH	Jamy		Sheet No.	2 from 4	

# EDCON-COMPONENTS

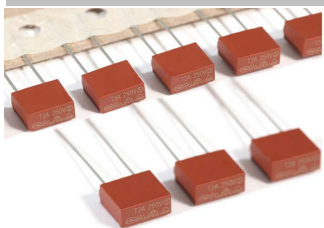

## Ordering Informations

Serie	Range Code	Voltage	ROHS	Packing						
-------	------------	---------	------	---------	--	--	--	--	--	--

<b>R23004</b>	-	<b>2A00</b>	<b>A</b>	<b>R</b>	<b>BL</b>					
---------------	---	-------------	----------	----------	-----------	--	--	--	--	--

<b>2A00= 2,00A</b>	<b>A= 250VAC</b>	<b>R= ROHS Conform</b>	<b>BL Bulk-Ware long Lead</b>
			<b>B4= Bulk-Ware lead length 4mm</b>
			<b>TR= Tape Reel 1000PCS standard</b>

<b>8,5mm Rectangular Fuse Time Lag</b>	
Part No.:	<b>R23004</b>
Customer:	

DRW:	Jason	CHKD	Wilson	MATL:	Wilson	TOLERANCE	Mason	DATE	11.05.2014
APPD:	Schumi			FINISH	Jamy		Sheet No.		3 from 4

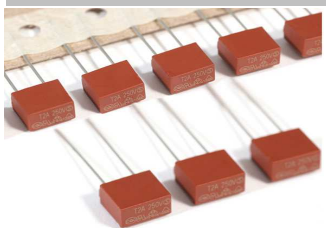

Soldering Profile Curve

Classification Reflow Profile (JEDEC J-STD-020C)

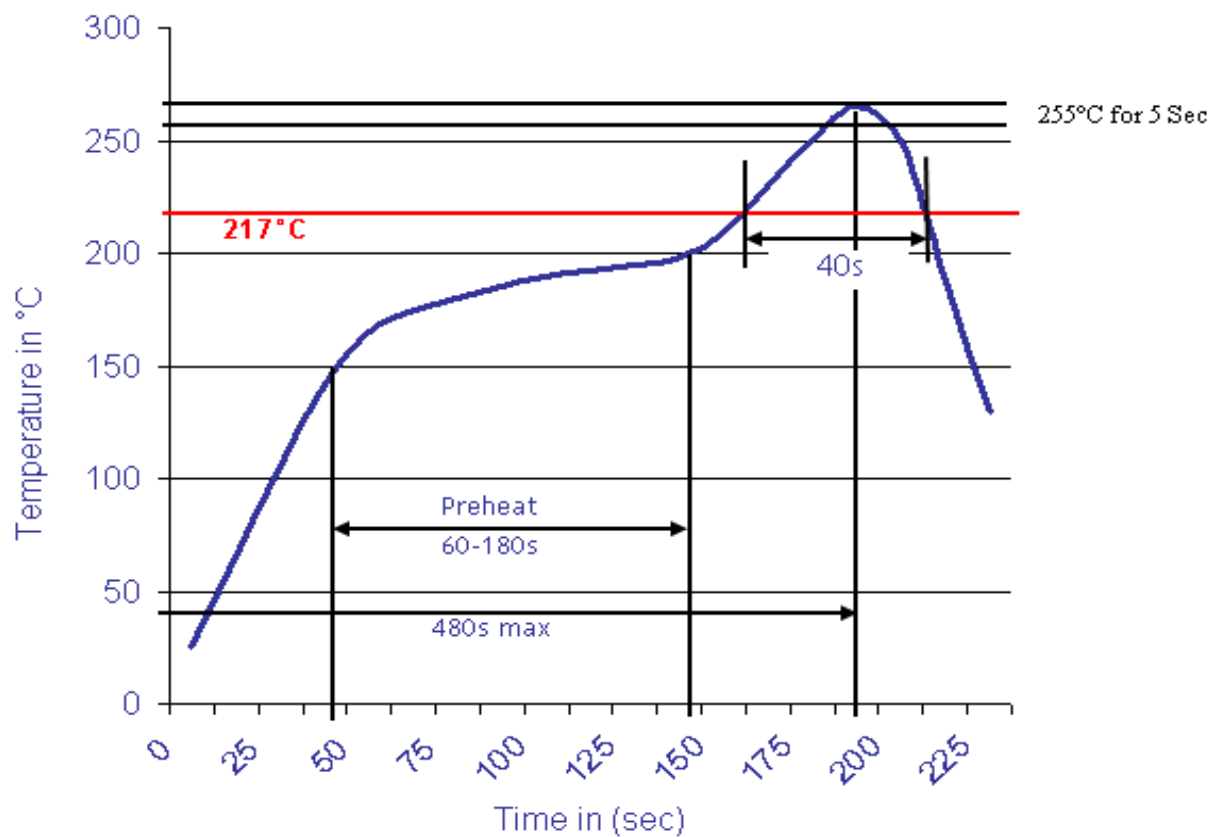

**8,5mm Rectangular Fuse Time Lag**

Part No.: **R23004**

DRW:	Jason	CHKD	Wilson	MATL:	Wilson	TOLERANCE	Mason	DATE	11.05.2014
APPD:	Schumi			FINISH	Jamy		Sheet No.	4 from 4	Customer: