

# EDCON-COMPONENTS

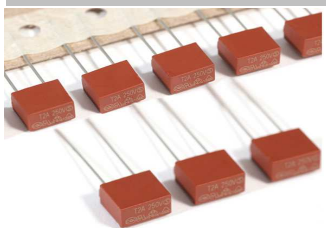

## Technical Description

**Standard:** IEC 60127, GB 9364  
**Operating Temperature:** . -55°C ~ + 125°C  
**Storage Temperature:** . -55°C ~ + 85°C  
**Solderability:** 245°C ± 5°C 5sec ± 0,5sec  
**Resistance to Soldering Head:** 260°C, 10s. Max.

### Electrical Characteristics:

2,1In Max. 2 minutes  
 2,75In Min 400ms  
 4In Max. 10 seconds  
 Min. 150ms  
 Max. 3 seconds  
 10In Min. 20ms  
 Max. 150ms

### Interrupting Capacity

CCC/ CQC /SEMKO / VDE / UR / BSI 35A or 10In 250VAC whichever is greater  
 TÜV 130A 250VAC (315mA ~ 10A)

**Range Code:** **0A500**

**Range:** **0A500= 500mA**

### TAPE-Box-Packing

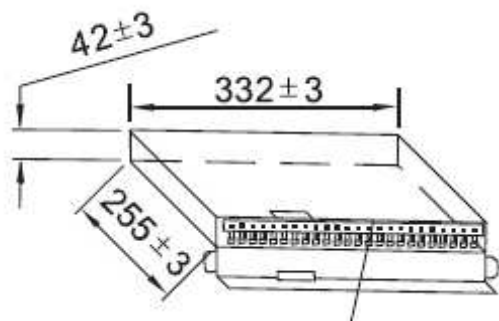

## Drawing (mm)

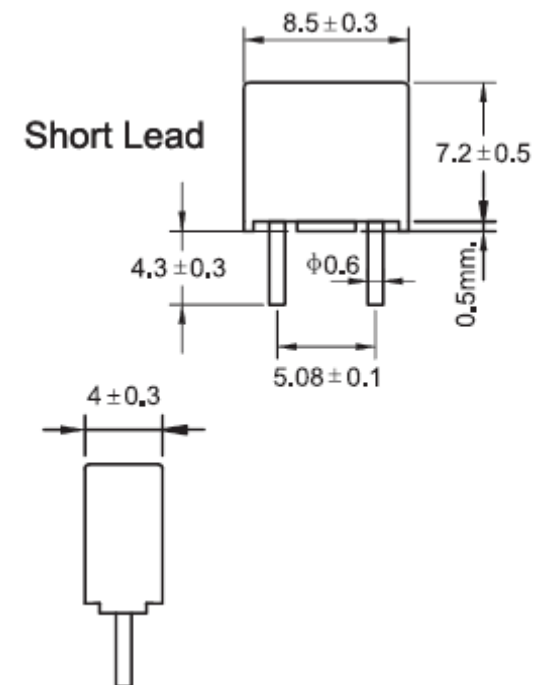

### Approvals 250VAC

CCC	
CQC	YES
SEMKO	YES
VDE	YES
URus	YES
BSI	YES
PSE	
KC	YES
TÜV	YES

**8,5mm Rectangular Fuse Time Lag**

Part No.: **R23004**

DRW:	Jason	CHKD	Wilson	MATL:	Wilson	TOLERANCE	Mason	DATE	11.05.2014
APPD:	Schumi			FINISH	Jamy		Sheet No.		1 from 4

Customer:

# EDCON-COMPONENTS

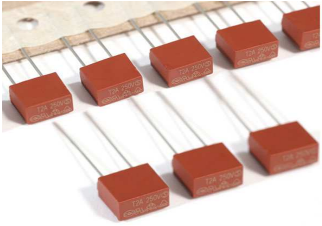

**Current Characteristics Curve**

**Tape/Box Packing**

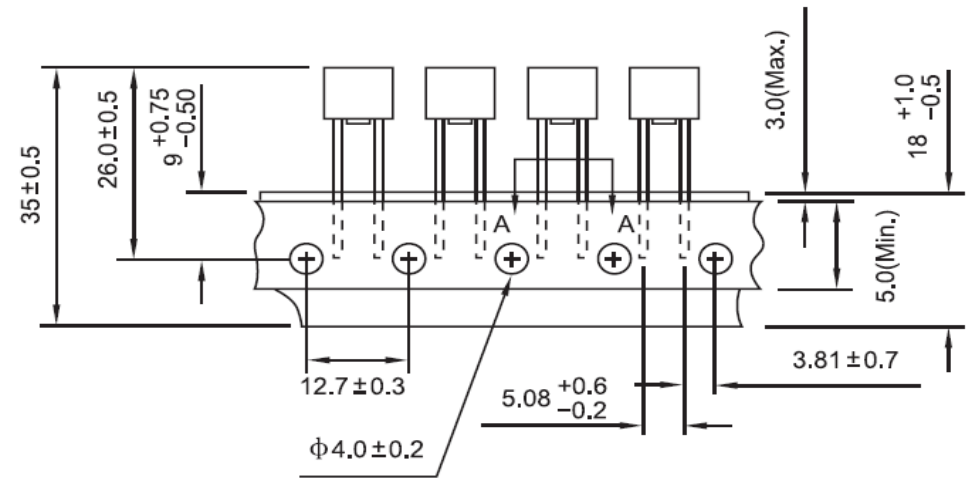
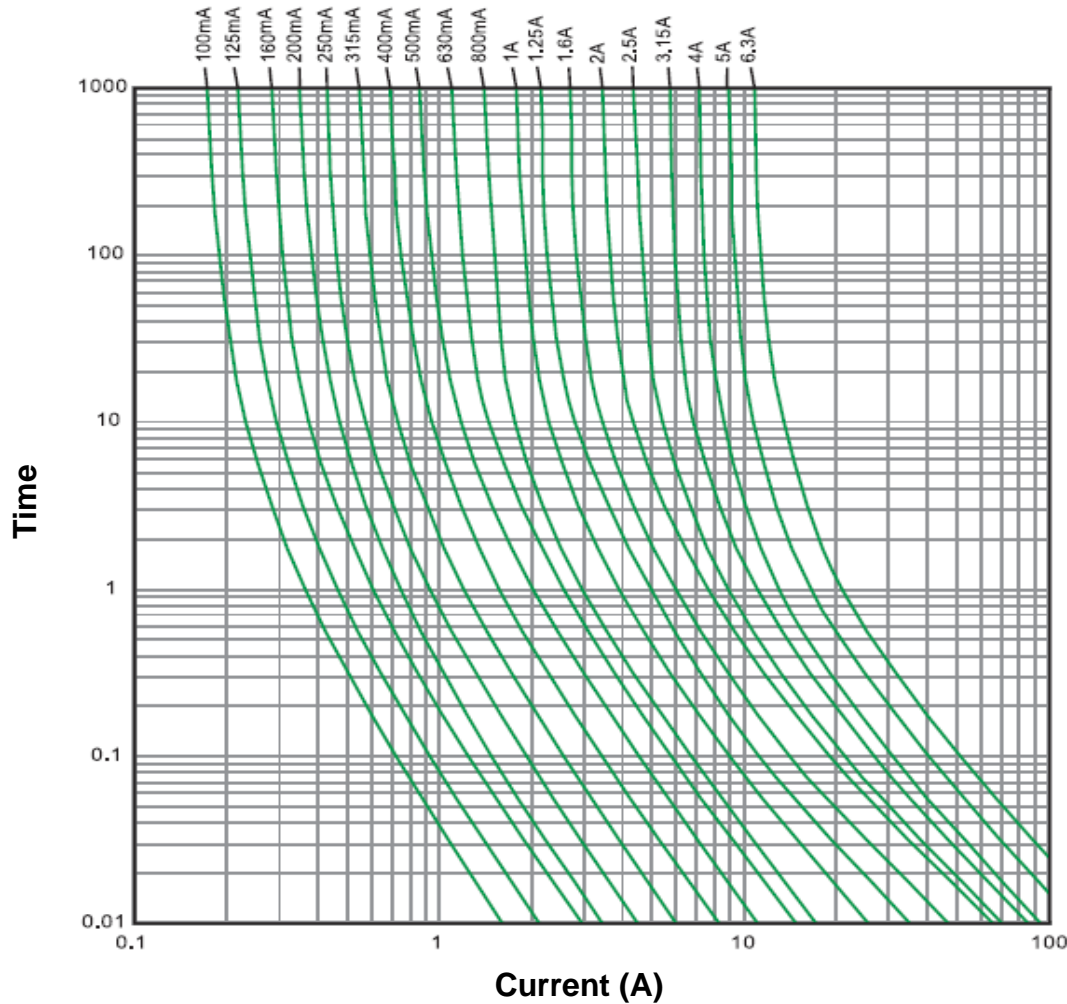

**8,5mm Rectangular Fuse Time Lag**

Part No.: **R23004**

DRW:	Jason	CHKD	Wilson	MATL:	Wilson	TOLERANCE	Mason	DATE	11.05.2014
APPD:	Schumi			FINISH	Jamy		Sheet No.	2 from 4	Customer:

# EDCON-COMPONENTS

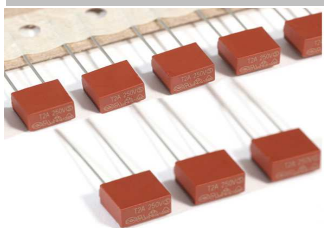

## Ordering Informations

Serie	Range Code	Voltage	ROHS	Packing						
-------	------------	---------	------	---------	--	--	--	--	--	--

<b>R23004</b>	-	<b>0A500</b>	<b>A</b>	<b>R</b>	<b>BL</b>					
---------------	---	--------------	----------	----------	-----------	--	--	--	--	--

<b>0A500=</b> 500mA	<b>A=</b> 250VAC	<b>R=</b> ROHS Conform	<b>BL</b> Bulk-Ware long Lead
			<b>B4=</b> Bulk- Ware lead length 4mm
			<b>TR=</b> Tape Reel 1000PCS standard

<b>8,5mm Rectangular Fuse Time Lag</b>
Part No.: <b>R23004</b>
Customer:

DRW:	Jason	CHKD	Wilson	MATL:	Wilson	TOLERANCE	Mason	DATE	11.05.2014
APPD:	Schumi			FINISH	Jamy		Sheet No.		3 from 4

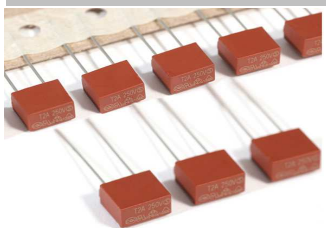

Soldering Profile Curve

Classification Reflow Profile (JEDEC J-STD-020C)



<b>8,5mm Rectangular Fuse Time Lag</b>	
Part No.:	<b>R23004</b>
Customer:	

DRW:	Jason	CHKD	Wilson	MATL:	Wilson	TOLERANCE	Mason	DATE	11.05.2014
APPD:	Schumi			FINISH	Jamy		Sheet No.	4 from 4	