



Technical Discription

Standard: UL248-1 + UL 248-14
Operating Temperature: . -55°C ~ + 125°C
Storage Temperature: . -55°C ~ + 85°C
Solderability: MIL-STD-202, Method 208

Electrical Characteristics:

% of Current Rating:
 100% 4 hours
 200% 1-60 seconds
 300% 0,2 - 3 seconds
 800% 0,01 ~ 0,1seconds

Interrupting Capacity

50A at 250VAC (200mA ~ 5A)
 100A at 125V DC/AC (200mA ~ 5A)

Range Code: 0A200

Range: 0A200= 200mA

Drawing (mm)

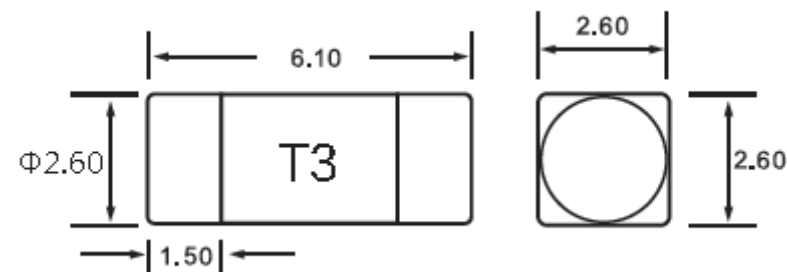

PCB Drawing (mm)

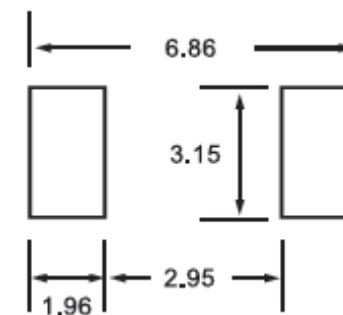

Packing (Box 1000PCS Tape/Reel)

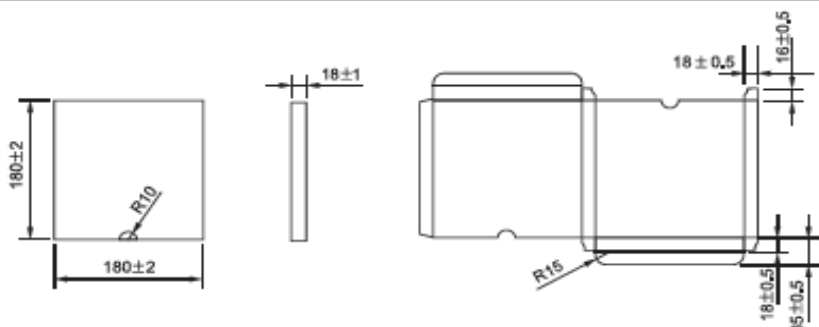

**SMD NANO Fuse
Slow Blow**

Part No.: R14004

DRW:	Jason	CHKD	Wilson	MATL:	Wilson	TOLERANCE	Mason	DATE	11.05.2014
APPD:	Schumi			FINISH	Jamy		Sheet No.	1 from 4	Customer:



Current Characteristics Curve

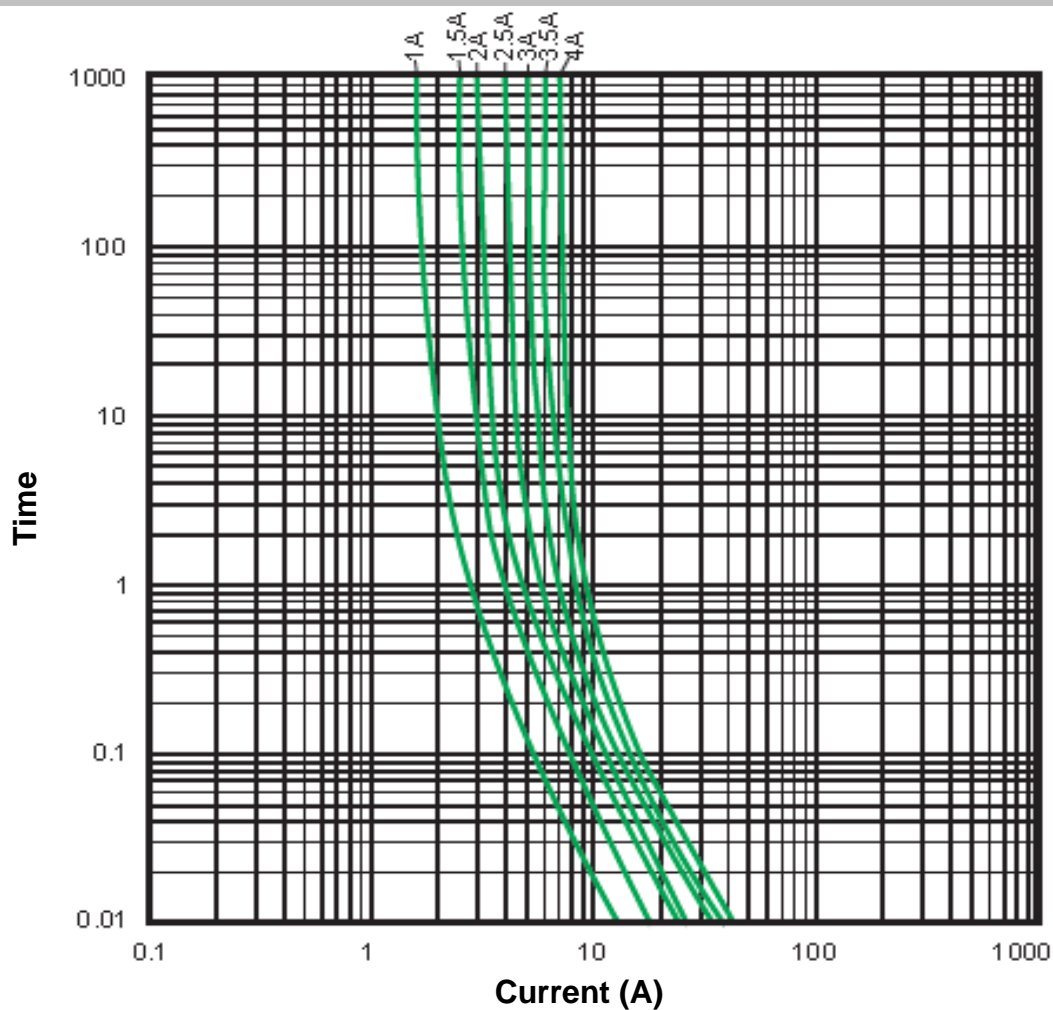

SMD NANO Fuse Slow Blow	
Part No.:	R14004
Customer:	

DRW:	Jason	CHKD	Wilson	MATL:	Wilson	TOLERANCE	Mason	DATE	11.05.2014
APPD:	Schumi			FINISH	Jamy		Sheet No.	2 from 4	

EDCON-COMPONENTS



Ordering Informations

Serie	Range Code	Voltage	ROHS	Packing						
-------	------------	---------	------	---------	--	--	--	--	--	--

R14004	-	0A200	A	R	TR					
---------------	---	--------------	----------	----------	-----------	--	--	--	--	--

0A200= 200mA	A= 250VAC (200mA~ 5A)	R= ROHS Conform	BU= Bulk- Ware 1000PCS
	B= 125VAC (200mA ~ 5A)		
			TR= Tape Reel 1000PCS standard

**SMD NANO Fuse
Slow Blow**

Part No.: **R14004**

DRW:	Jason	CHKD	Wilson	MATL:	Wilson	TOLERANCE	Mason	DATE	11.05.2014
APPD:	Schumi			FINISH	Jamy		Sheet No.		3 from 4

Customer:



Soldering Profile Curve

Classification Reflow Profile (JEDEC J-STD-020C)



SMD NANO Fuse	
Slow Blow	
Part No.:	R14004
Customer:	

DRW:	Jason	CHKD	Wilson	MATL:	Wilson	TOLERANCE	Mason	DATE	11.05.2014
APPD:	Schumi			FINISH	Jamy		Sheet No.	4 from 4	