

EDCON-COMPONENTS

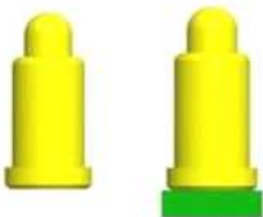

Technical Discription

Material:
 Insulator: Black High Temperatur plastics UI94 V-0
 Plunger: Brass C3604 Au 20μ over Ni
 Barrel: Brass C3604 Au 20μ over Ni
 Spring: SUS 304 Au over Ni

Mechanical:
 Spring force: 90g +/- 20gr at 1,0mm working stroke
 Full stroke: 1,40mm
 Life Test: 1.000.000 cycles

Electrial:
 Rated Current & Voltage: DC 12V ; 2A max.
 Contact Resistance: 50milliohm max.

Insulator Height A

A: 4,5mm
 B: 5,0mm

Drawing

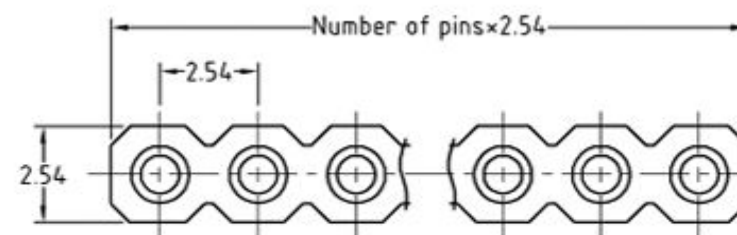
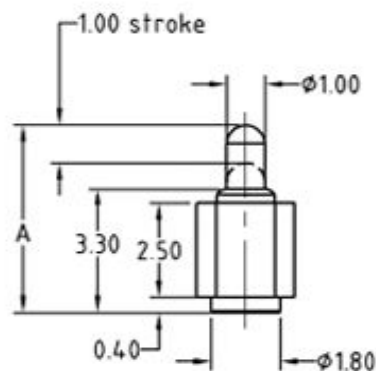

SMT POGO PIN CONNECTOR
Pitch 2,54mm

Part No.: **TA23A001**

DRW:	Jason	CHKD	Wilson	MATL:	Wilson	TOLERANCE	Mason	DATE	12.04.2014
APPD:	Schumi			FINISH	Jamy		Sheet No.	1 from 3	Customer:

EDCON-COMPONENTS

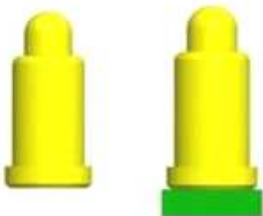

Ordering Informations

Serie	No of Pos.	Body Height	Contact Plating	Special	ROHS	Packing				
-------	------------	-------------	-----------------	---------	------	---------	--	--	--	--

TA23A001	xx	A	020	X	R	BU				
-----------------	-----------	----------	------------	----------	----------	-----------	--	--	--	--

xx= 02 ~ 32Pos.	A= 4,5mm	020= 20µ AU	X= no function	R= ROHS Conform	BU= Bulk-Ware
	B= 5,0mm			N= NON ROHS Conform	

SMT POGO PIN CONNECTOR
Pitch 2,54mm

Part No.: **TA23A001**

DRW:	Jason	CHKD	Wilson	MATL:	Wilson	TOLERANCE	Mason	DATE	12.04.2014
APPD:	Schumi			FINISH	Jamy		Sheet No.		2 from 3

Customer:

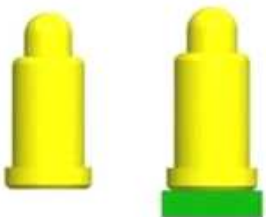

Soldering Profile Curve

Classification Reflow Profile (JEDEC J-STD-020C)



SMT POGO PIN CONNECTOR	
Pitch 2,54mm	
Part No.:	TA23A001
Customer:	

DRW:	Jason	CHKD	Wilson	MATL:	Wilson	TOLERANCE	Mason	DATE	12.04.2014
APPD:	Schumi			FINISH	Jamy		Sheet No.	3 from 3	