

# EDCON-COMPONENTS

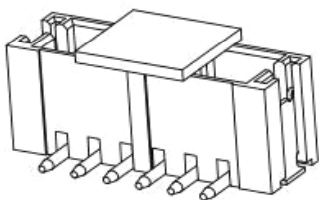

## Specifications

Voltage Rating:	250 V AC/DC
Current Rating:	1A AC/DC
Operating Temperature:	-25°C to +85°C
Contact Resistance:	20 mΩ
Withstanding Voltage:	500 V AC/Minute
Insulation Resistance:	500MΩ min.
Material Housing:	LCP / UL94V-0
Pin-Material:	Phosphor / Tin-plated
Pantone Color:	7528C



## Drawing ( dimensions all into mm)

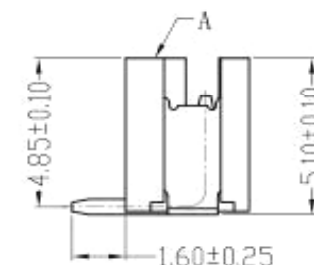
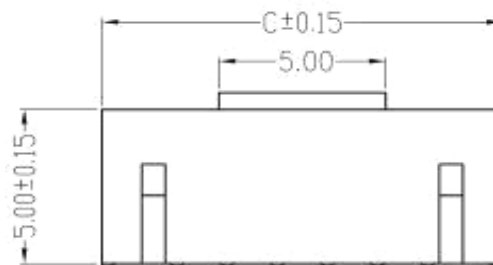

## P.C.B. Layout

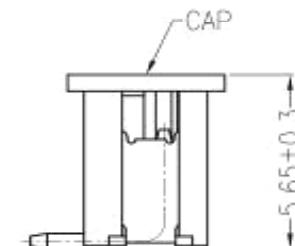
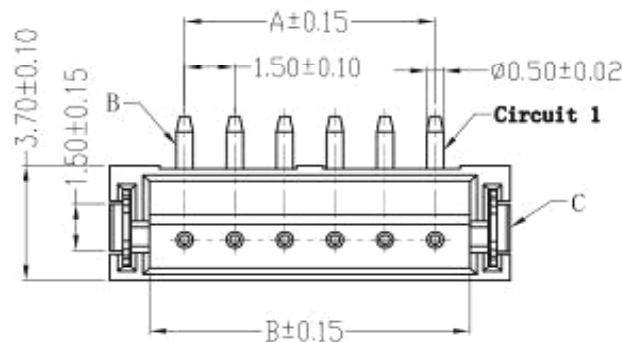
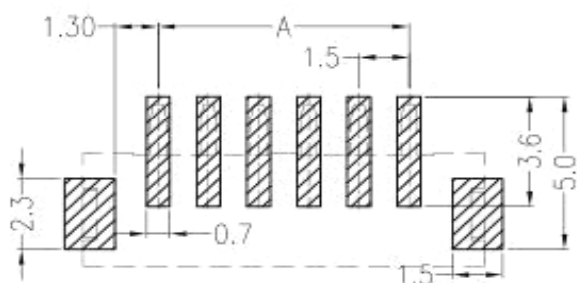

SMT Wafer Serie T68Sxxxx Pitch  
1,50mm ( TOP-Entry)

Part No.: **T68K007 -**

DRW:	Jason	CHKD	Wilson	MATL:	Wilson	TOLERANCE	Mason	DATE	08.05.2021
APPD:	Schumi			FINISH	Jamy		Sheet No.	1 from 4	Customer:

# EDCON-COMPONENTS

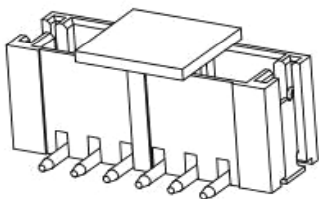

## Dimension Information about Housing

Pos.	Dimension (mm)					
	A	B	C	D	E	F
2	1,50	3,60	6,00			
3	3,00	5,10	7,50			
4	4,50	6,60	9,00			
5	6,00	8,10	10,50			
6	7,50	9,60	12,00			
7	9,00	11,10	13,50			
8	10,50	12,60	15,00			
9	12,00	14,10	16,50			
10	13,50	15,60	18,00			
11	15,00	17,10	19,50			
12	16,50	18,60	21,00			
13	18,00	20,10	22,50			
14	19,50	21,60	24,00			
15	21,00	23,10	25,50			
16	22,50	24,60	27,00			

SMT Wafer Serie T68Sxxxx Pitch 1,50mm ( TOP-Entry)	
Part No.:	<b>T68K007 -</b>
Customer:	

DRW:	Jason	CHKD	Wilson	MATL:	Wilson	TOLERANCE	Mason	DATE	08.05.2021
APPD:	Schumi			FINISH	Jamy		Sheet No.	2 from 4	

# EDCON-COMPONENTS

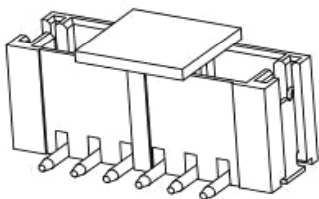

## Ordering Informations

Serie	Number of Pos.	Special function	Color of Body	Packing						
-------	----------------	------------------	---------------	---------	--	--	--	--	--	--

<b>T68K007 -</b>	<b>02</b>	<b>X</b>	<b>GY</b>	<b>BU</b>						
------------------	-----------	----------	-----------	-----------	--	--	--	--	--	--

<b>xx = Pos.</b>	<b>X= No function</b>	<b>GY= Gray</b>	<b>BU= Bulk-ware</b>							
			<b>TR= Tape / Reel Packing</b>							

SMT Wafer Serie T68Sxxxx Pitch 1,50mm ( TOP-Entry)

Part No.: **T68K007 -**

DRW:	Jason	CHKD	Wilson	MATL:	Wilson	TOLERANCE	Mason	DATE	08.05.2021
APPD:	Schumi			FINISH	Jamy		Sheet No.		3 from 4

Customer:

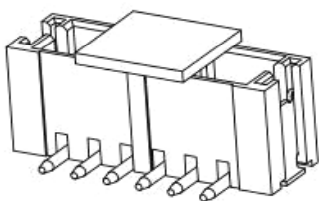

Soldering Profile Curve

Classification Reflow Profile (JEDEC J-STD-020C)

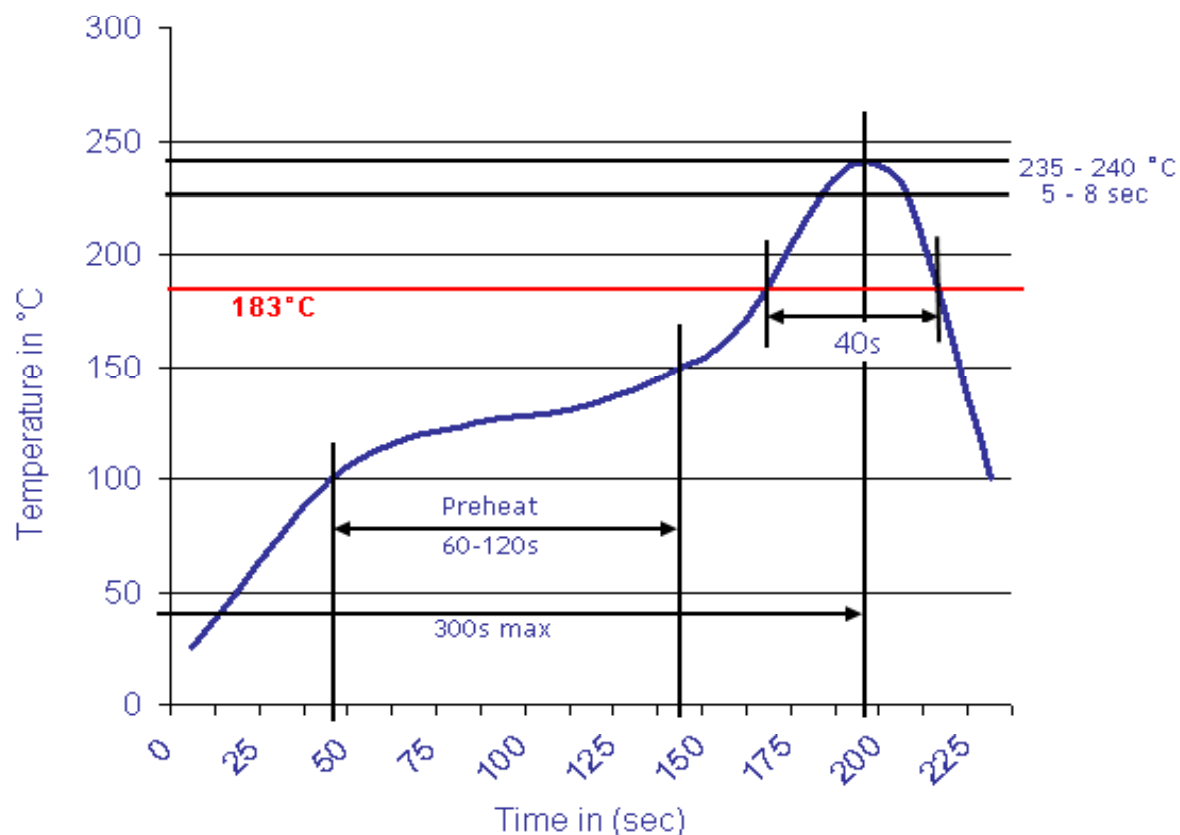

SMT Wafer Serie T68Sxxxx Pitch  
1,50mm ( TOP-Entry)

Part No.: **T68K007 -**

DRW:	Jason	CHKD	Wilson	MATL:	Wilson	TOLERANCE	Mason	DATE	08.05.2021	Customer:
APPD:	Schumi			FINISH	Jamy		Sheet No.	4 from 4		