

EDCON-COMPONENTS

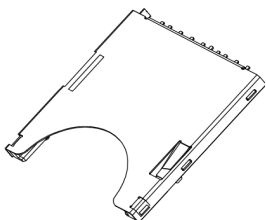

Specifications

Housing:	HI-TEMP Plastic UL 94V-0
Terminal:	Brass
Plating:	Gold Plated on Contact Area G/F plated on Solder Tails
Shell:	Stainless Steel
Plating:	50µ" Nickel under 100µ TIN Over
Electrical:	
Current Rating:	0,5A max.
Dielectric Withstanding V.:	500VAC R.M.S. for 1 Minute
Insulation Resistance:	100MΩ min at 500V DC
Contact Resistance:	50mΩ Max.
Switch Resistance:	100mΩ Max.
Durability:	5000 Cycles:
Operating Temperature:	.-30°C to +85°C

Drawing (dimensions all into mm)

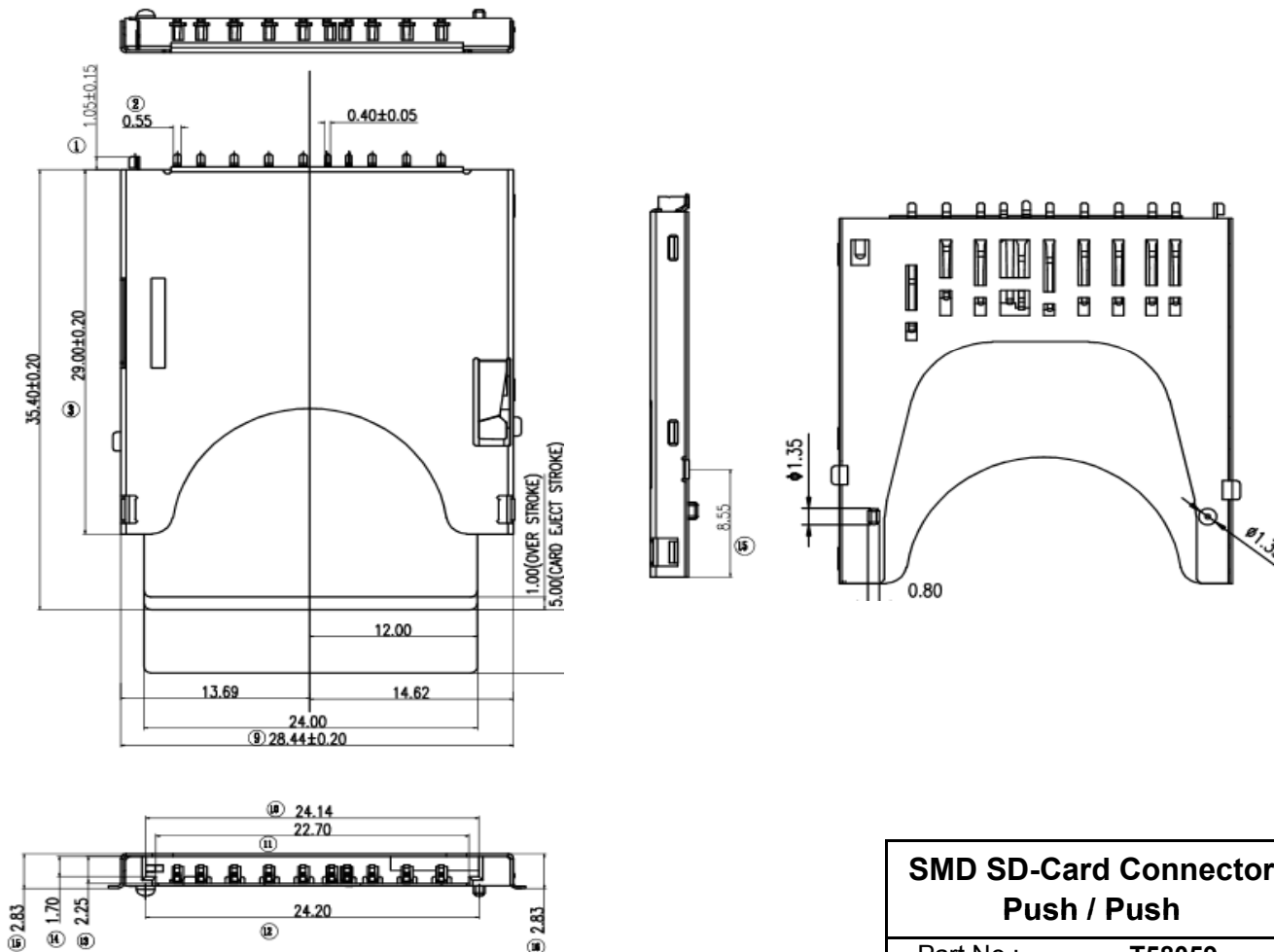

SMD SD-Card Connector Push / Push	
Part No.:	T58059
Customer:	

DRW:	Jason	CHKD	Wilson	MATL:	Wilson	TOLERANCE	Mason	DATE	09.03.2024
APPD:	Schumi			FINISH	Jamy			Sheet No.	1 from 4

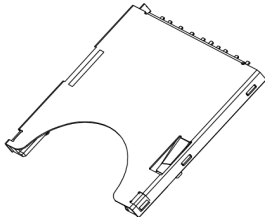

Dimension Information about Housing

PCB Layout

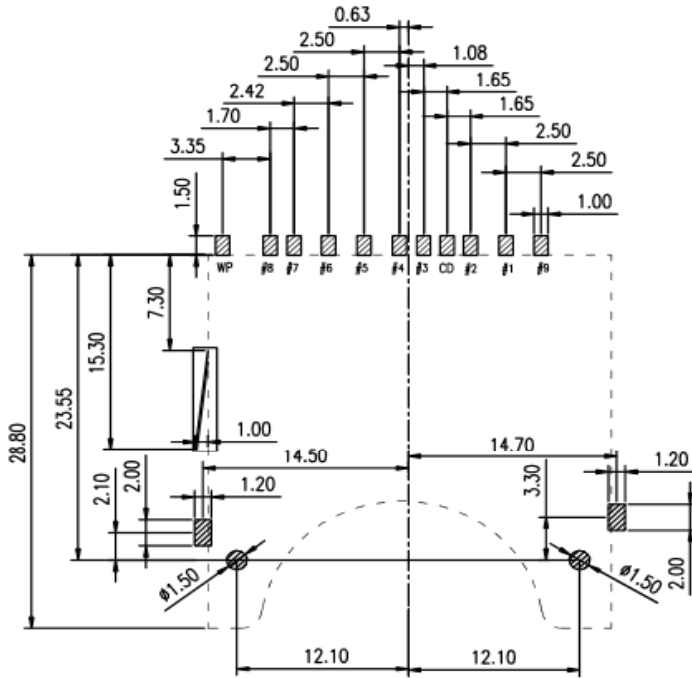

SD CARD PIN DESIGN

PIN NO.	NAME	TYPE	DESCRIPTION
#1	CD/DAT3	I/O/PP	CARD DETECT/DATA LINE(BIT3)
#2	CMD	PP	COMMAND/RESPONSE
#3	VSS1	S	SUPPLY VOLTAGE GROUND
#4	VDD	S	SUPPLY VOLTAGE
#5	CLK	I	CLOCK
#6	VSS2	S	SUPPLY VOLTAGE GROUND
#7	DAT0	I/O/PP	DATA LINE(BIT 0)
#8	DAT1	I/O/PP	DATA LINE(BIT 1)
#9	DAT2	I/O/PP	DATA LINE(BIT 2)

CIRCUIT

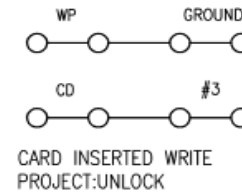
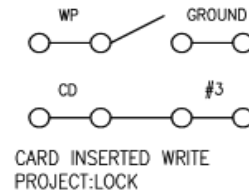
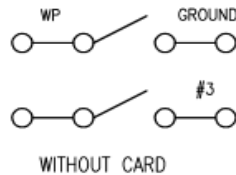

**SMD SD-Card Connector
Push / Push**

Part No.: **T58059**

DRW:	Jason	CHKD	Wilson	MATL:	Wilson	TOLERANCE	Mason	DATE	09.03.2024
APPD:	Schumi			FINISH	Jamy		Sheet No.		2 from 4

Customer:

EDCON-COMPONENTS

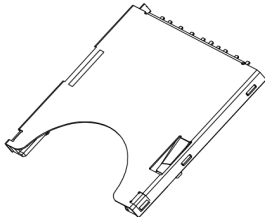

Ordering Informations

Serie	Contacts	Contact Plating	Shell Material	Special Function	Special Function	ROHS	Packing			
T58059	9	G0	SS	N	N	R	TR			

9 = Number of Contacts	G0 = Standard Gold	SS = Stainless Steel	N = No Function	N = No Function	R = ROHS Conform	TR = Tape Reel
					N = NON ROHS	BU = Bulk-Ware

SMD SD-Card Connector Push / Push	
Part No.:	T58059
Customer:	

DRW:	Jason	CHKD	Wilson	MATL:	Wilson	TOLERANCE	Mason	DATE	09.03.2024
APPD:	Schumi			FINISH	Jamy		Sheet No.		3 from 4

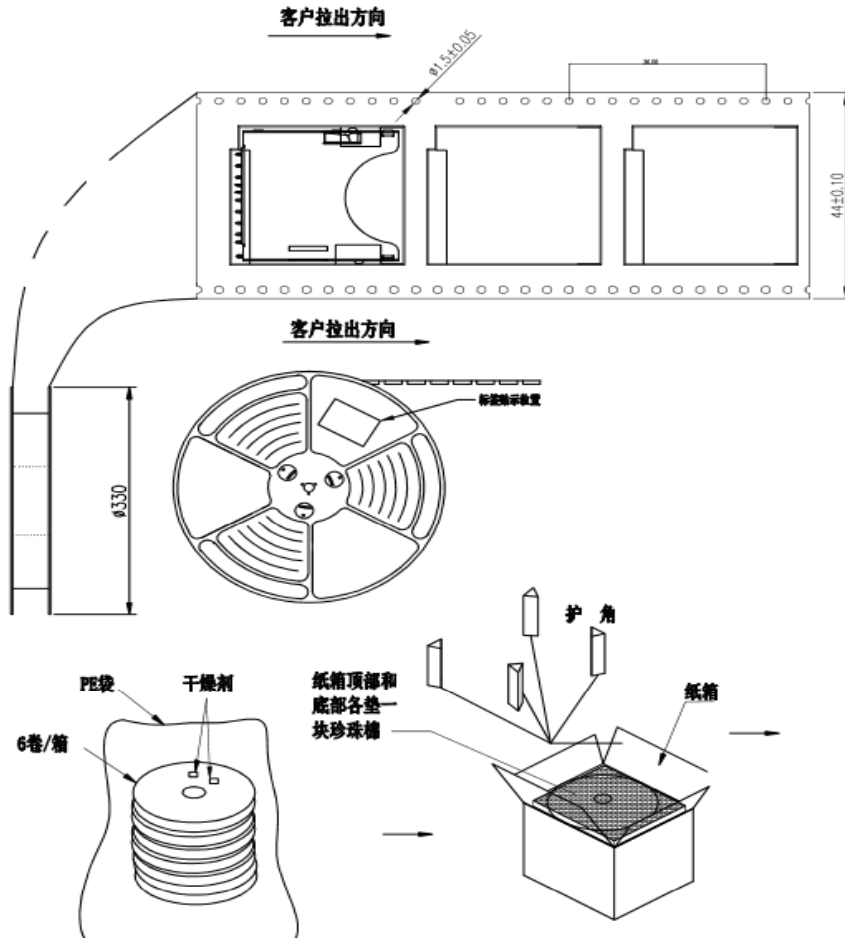
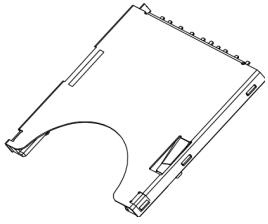

NOTES

- 每卷包装数量:350PCS/每卷
- 卷带包装方式:

空5PCS	产品350PCS	空5PCS
轴心段空180mm	产品放置区	尾部 180mm
- 每箱包装数量:2100PCS/箱

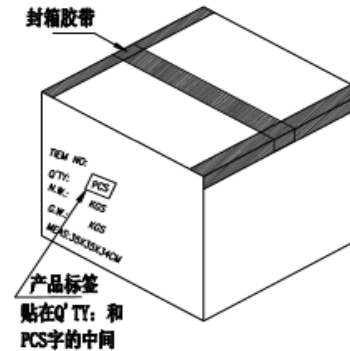

SMD SD-Card Connector Push / Push	
Part No.:	SMD SD-Card
Customer:	

DRW:	Jason	CHKD	Wilson	MATL:	Wilson	TOLERANCE	Mason	DATE	09.03.2024
APPD:	Schumi			FINISH	Jamy		Sheet No.	4 from 4	