

# EDCON-COMPONENTS

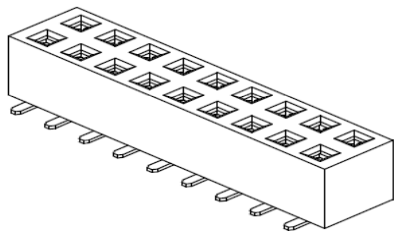

## Specifications

Current Rating:	1 Ampere
Insulator Resistance:	1000 Megaohm min.
Contact Resistance	20m Ohm max.
Dielectric Withstanding:	AC 500V
Operating Temperature:	.-40°C to +105°C
Contact Material:	Brass
Insulator Material:	Polyester, UL 94V-0
Standard:	Nylon 6T
Contact Plating:	Tin, Gold or Selective Plated
Standard:	Gold Flash Overall

## P.C.B Layout

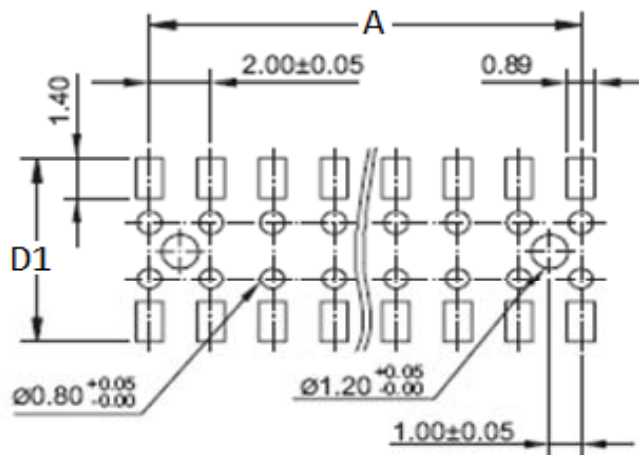

## Drawing

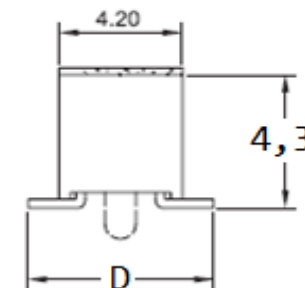
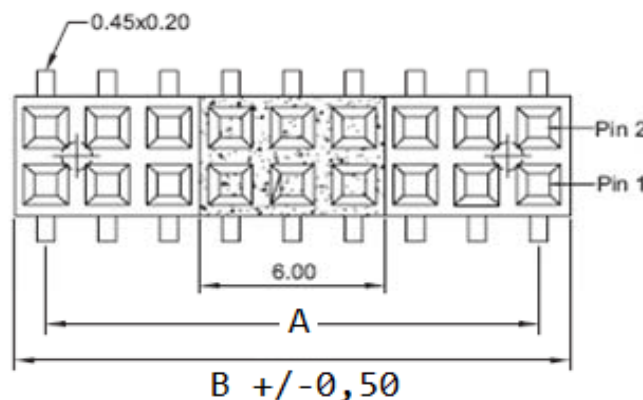
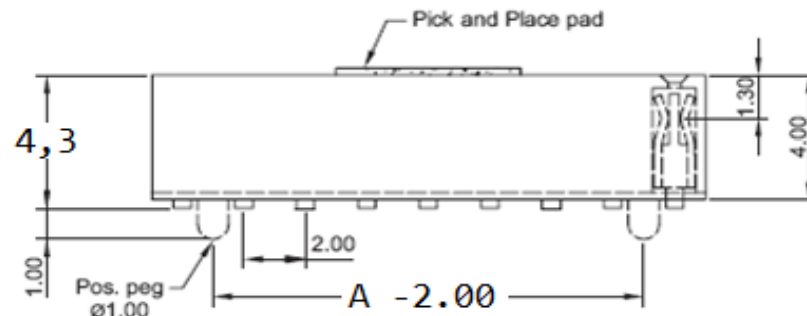

**Locating Peg Option** Order code  
With or Without Locating PEG

**Female Header Pitch**  
**2,00mm**

Part No.: **T27B1069-**

DRW:	Jason	CHKD	Wilson	MATL:	Wilson	TOLERANCE	Mason	DATE	22.05.2019
APPD:	Schumi			FINISH	Jamy		Sheet No.		1 from 4

[www.edcon-components.com](http://www.edcon-components.com)

email: [info@edcon-components.com](mailto:info@edcon-components.com)

# EDCON-COMPONENTS

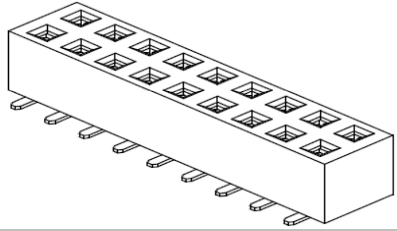

## Pin Code length table free configuration

Order Code	Dimension (mm)		
	D	D1	
A01	6,00	7,00	
A02			
A03			
A04			
A05			
A06			
A07			
A08			
A09			
A10			
A11			
A12			
A13			
A14			
A15			
A16			
A17			
A18			
A19			
A20			
A21			
A22			

Order Code	Dimension (mm)		
	D	D1	
A23			
A24			
A25			
A26			
A27			
A28			
A29			
A30			
A31			
A32			
A33			
A34			
A35			
A36			
A37			
A38			
A39			
A40			
A41			
A42			
A43			
A44			

Order Code	Dimension (mm)		
	D	D1	
A45			
A46			
A47			
A48			
A49			
A50			
A51			
A52			
A53			
A54			
A55			
A56			
A57			
A58			
A59			
A60			
A61			
A62			
A63			
A64			
A65			
A66			

**Female Header Pitch  
2,00mm**

Part No.: **T27B1069-**

DRW:	Jason	CHKD	Wilson	MATL:	Wilson	TOLERANCE	Mason	DATE	22.05.2019
APPD:	Schumi			FINISH	Jamy		Sheet No.		2 from 4

Customer:

# EDCON-COMPONENTS

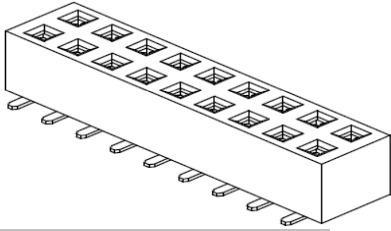

## Ordering Informations

Serie	No. of Pos.	Construction	Contact Plating	Material	Locating Peg	Pin Length Code	ROHS	Packing		
<b>T27B1069-</b>	<b>XX</b>	<b>SS</b>	<b>G0</b>	<b>PB</b>	<b>N</b>	<b>A01</b>	<b>R</b>	<b>BU</b>		

<b>04 ~ 80Pos.</b>	<b>SS=</b> Straight SMT	<b>G0=</b> Gold Flash (Standard)	<b>PB=</b> P.B.T	<b>N=</b> without Locating Peg	look Table No. 1	<b>N=</b> NO ROHS conform	<b>BU=</b> Bulk (Standard)
		<b>T0=</b> Tin plated					
		<b>GA=</b> 10µ Gold Plating			<b>TC=</b> Tube w. pic and Place Cap		
		<b>GB=</b> 15µ Gold Plating					
		<b>GC=</b> 20µ Gold Plating					
		<b>S0=</b> Selectiv Plating Gold Flash / Tin				<b>TY=</b> Tray packing w/o Cap	
	<b>TR=</b> Tape/Reel w. pic and Place Cap						

**Female Header Pitch  
2,00mm**

Part No.: **T27B1069-**

DRW:	Jason	CHKD	Wilson	MATL:	Wilson	TOLERANCE	Mason	DATE	22.05.2019
APPD:	Schumi			FINISH	Jamy		Sheet No.		3 from 4

Customer:

# EDCON-COMPONENTS

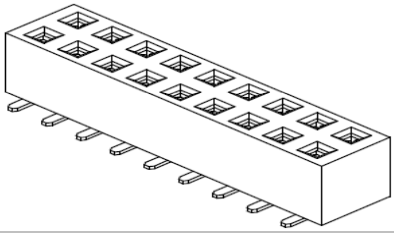

## Soldering Profile for Lead Soldering ( P.B.T. )

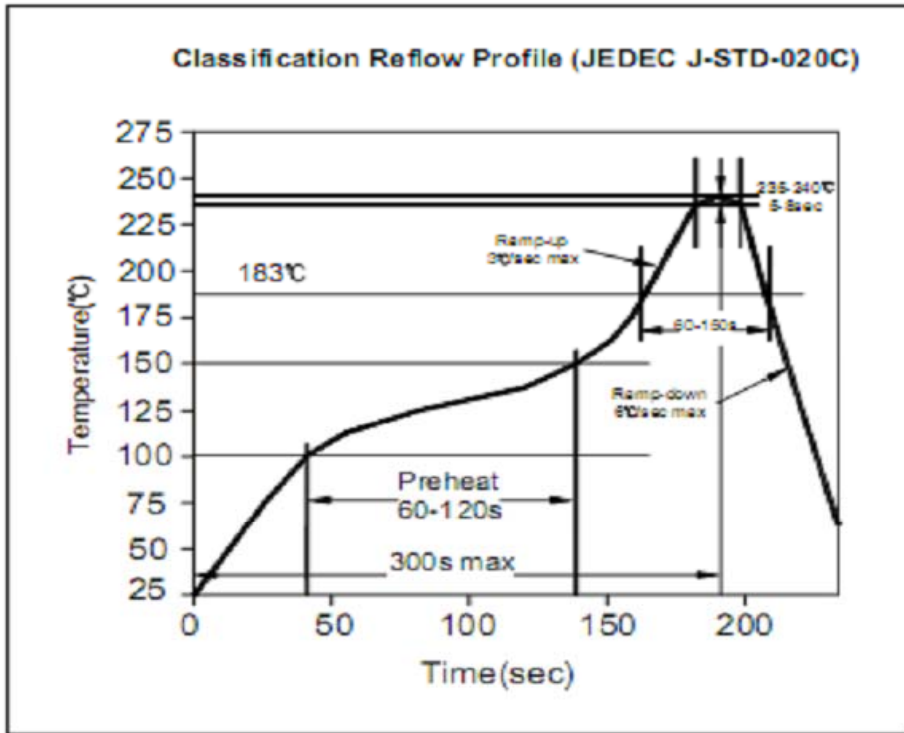

## Soldering Profile for Lead Free Soldering ( Nylon 6T )

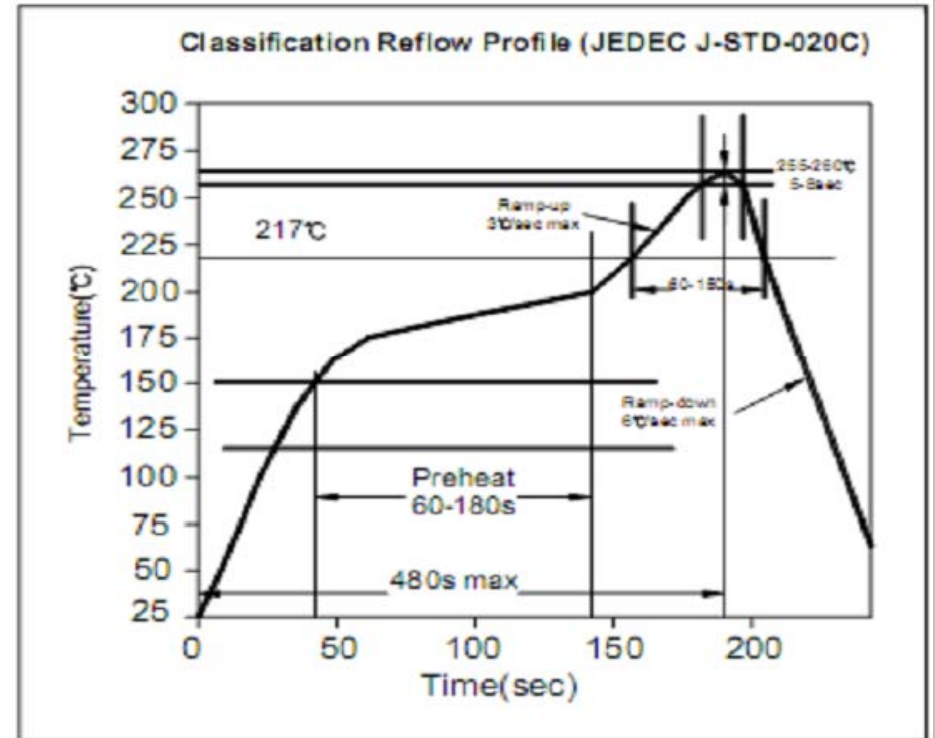

**Female Header Pitch  
2,00mm**

Part No.: **T27B1069-**

DRW:	Jason	CHKD	Wilson	MATL:	Wilson	TOLERANCE	Mason	DATE	22.05.2019
APPD:	Schumi			FINISH	Jamy		Sheet No.	4 from 4	Customer:

[www.edcon-components.com](http://www.edcon-components.com)

email: [info@edcon-components.com](mailto:info@edcon-components.com)