

EDCON-COMPONENTS

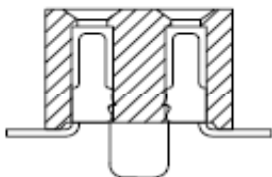

Specifications

Current Rating:	3 Ampere
Insulator Resistance:	1000 Megaohm min.
Contact Resistance	20m Ohm max.
Dielectric Withstanding:	AC 500V
Operating Temperature:	.-40°C to +105°C
Contact Material:	Phosphor Bronze
Insulator Material:	Polyester, UL 94V-0
Standard:	Nylon 6T
Contact Plating:	Full Tin, Full Gold flash
Standard:	Gold Flash Overall

Drawing (mm)

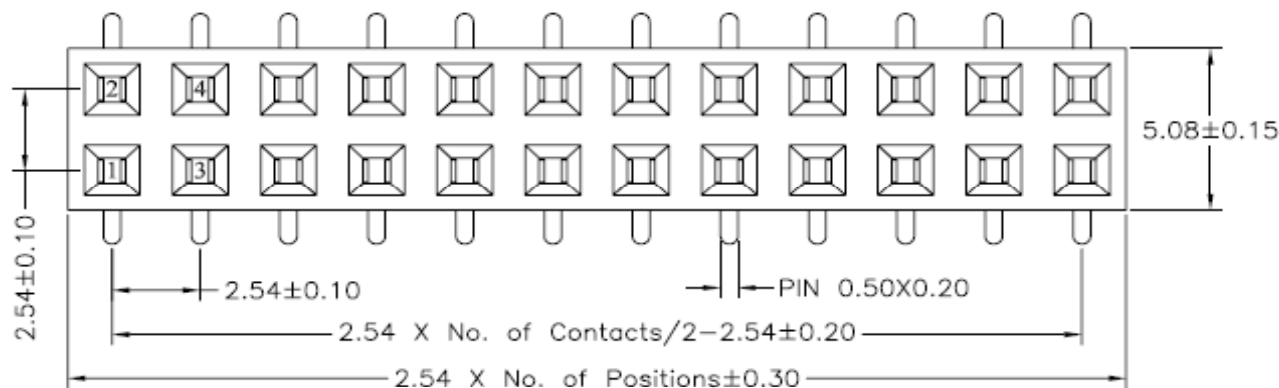

P.C.B Layout

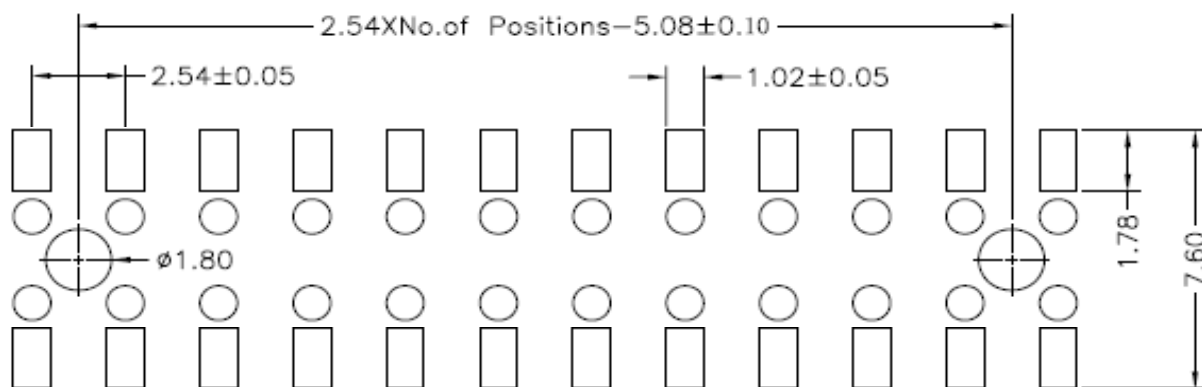

**SMT Female Header Pitch
2,54mm Body 3,55mm**

Part No.: **T27A1204-**

Customer:

DRW:	Jason	CHKD	Wilson	MATL:	Wilson	TOLERANCE	Mason	DATE	29.01.2021
APPD:	Schumi			FINISH	Jamy		Sheet No.	1 from 4	

EDCON-COMPONENTS

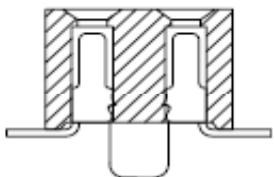

Pin Code length table free configuration

Drawing (mm)

Order Code	Dimension (mm)			
	A			
A01	7,20			
A02				
A03				
A04				
A05				
A06				
A07				
A08				
A09				
A10				
A11				
A12				
A13				
A14				
A15				
A16				
A17				
A18				
A19				
A20				
A21				
A22				

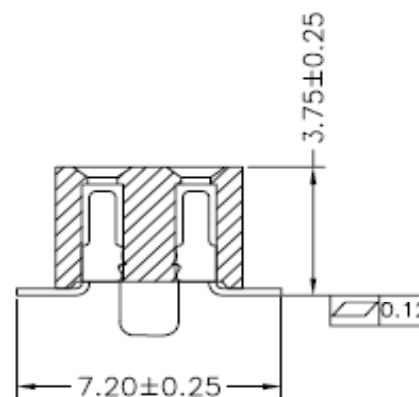
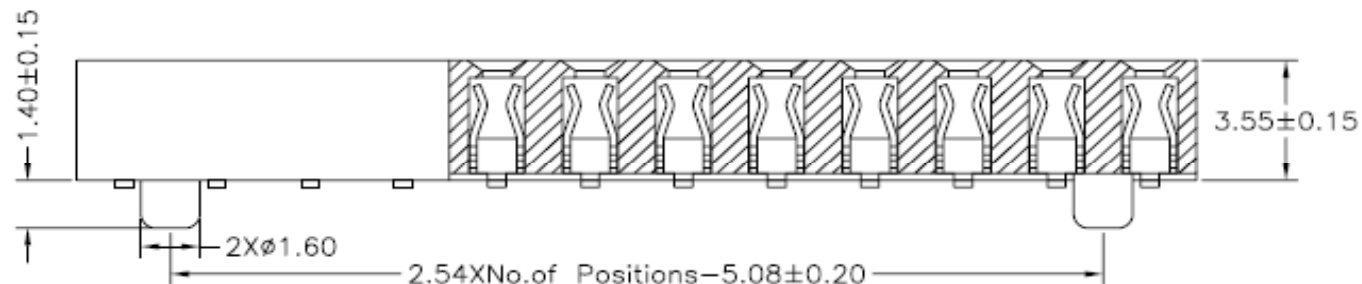

SMT Female Header Pitch 2,54mm Body 3,55mm	
Part No.:	T27A1204-
Customer:	

DRW:	Jason	CHKD	Wilson	MATL:	Wilson	TOLERANCE	Mason	DATE	29.01.2021
APPD:	Schumi			FINISH	Jamy		Sheet No.	2 from 4	

EDCON-COMPONENTS

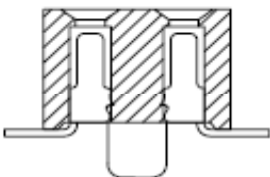

Ordering Informations

Serie	No. of Pos.	Construction	Contact Plating	Material	Polarisations PEG	Pin Length Code	ROHS	Packing		
T27A1204-	XX	SS	G0	NY	Y	A01	R	BU		

XX= Total Pin	SS= Straight SMT	G0= Gold Flash (Standard)	PB= P.B.T	Y= with Peg	siehe Table No. 1	N= NO ROHS conform	BU= Bulk (Standard)
		T0= Tin plated	NY= Nylon-6T (Standard)	N= without Peg		R= ROHS conform	TU= Tube w/o Cap
		GA= 10µ Gold Plating	PA= PA-46				TC= Tube w. pic and Place Cap
		GB= 15µ Gold Plating					TY= Tray packing w/o Cap
		GC= 20µ Gold Plating					TR= Tape/Reel w. pic and Place Cap
		S0= Selectiv Plating Gold Flash / Tin					
		TN= Tin Plated					

**SMT Female Header Pitch
2,54mm Body 3,55mm**

Part No.: **T27A1204-**

DRW:	Jason	CHKD	Wilson	MATL:	Wilson	TOLERANCE	Mason	DATE	29.01.2021
APPD:	Schumi			FINISH	Jamy		Sheet No.		3 from 4

Customer:

EDCON-COMPONENTS

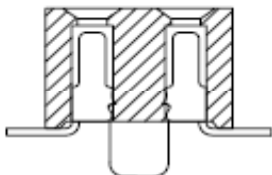

Soldering Profile for Lead Soldering (P.B.T.)

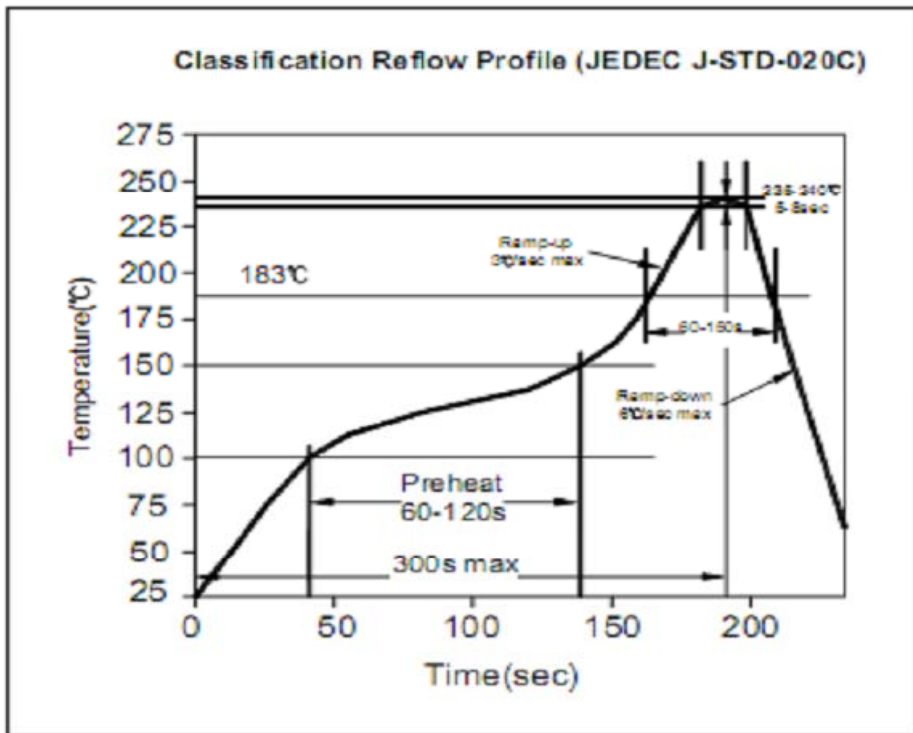

Soldering Profile for Lead Free Soldering (Nylon 6T)

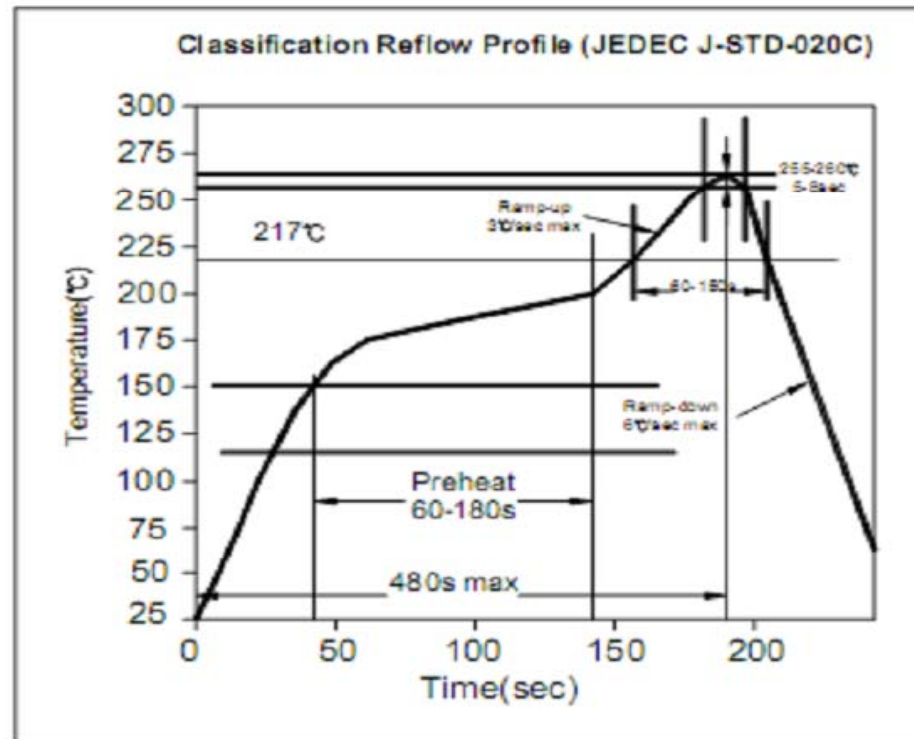

**SMT Female Header Pitch
2,54mm Body 3,55mm**

Part No.: **T27A1204-**

DRW:	Jason	CHKD	Wilson	MATL:	Wilson	TOLERANCE	Mason	DATE	29.01.2021
APPD:	Schumi			FINISH	Jamy		Sheet No.	4 from 4	Customer: