

Technical Informations

FEATURES

Magnetic Shielded surface mount inductor
with high current rating.
Low resistance to keep power loss minimum.

OPTIONS

Tape & Reel (Standard)
Tolerance: M=20% (Standard,)
Tighter Tolerances Available

APPLICATIONS

Excellent for power line DC-DC conversions
used in hard disk, notebook computer and
other electronic equipment.

PHYSICAL CHARACTERISTICS

- Inductance is measured by LCR-meter 4284A / 4286A (HP) or equivalent.
 - DC Resistance is measured by HP4338B Milliohms Meter or equivalent.
 - Rated current is measured by LCR-meter 3260B (WK) & DC Bias 3265B(WK).
 - Maximum allowable DC current is that which causes a 25% inductance reduction from the initial value, or coil temperature to rise by 40°C, whichever is smaller.
- Ambient Temperature . -40°C to + 85°C
- Operating Temperature . -40°C to + 125°C
 - Storage Temperature . -20°C to + 60°C 75%RH max

ELECTRICAL SPECIFICATIONS

Properties	Test Conditions		Value	Unit	Tol.
Inductance	100Khz/250mV	L	220	µH	look Order.
Rated Current	ΔT = 40K	IDC	1,45	A	max.
Saturation Current	ΔL/LI <10%	Isat	1,6	A	typ.
DC-resistance	at20°C	DCR typ.	0,205	Ω	typ.
DC-resistance	at20°C	DCR max.	0,245	Ω	max.
Self-Res. Freq.		SRF	2,9	MHz	typ.

1. This electronic component is meant to be used in general electronic equipment. Before the incorporation of this component into any equipment with higher and more reliable requirements such as aviation, aerospace, submarine, nuclear control, transportation, transportation signal, disaster prevention, medical, public information network, etc. or if there is a possibility of injuries or damages to the human body, Edcon –Components must be informed before the stage of design-in. Evaluation checks for safety have to be performed on each electronic components used in electrical circuits that require high safety and reliability functions.

SMT SHIELDED POWER INDUCTOR

Part No.: **S47006-221**

Customer:

DRW:	Chang	CHKD	Young	MATL:	Chu Chi	DATE	05.06.2018
APPD:	Pong			FINISH	Vienna	Sheet	1 from 2

Copyright by S.Tiede

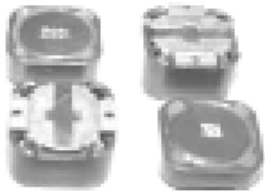

TECHNICAL Dimensions (mm)

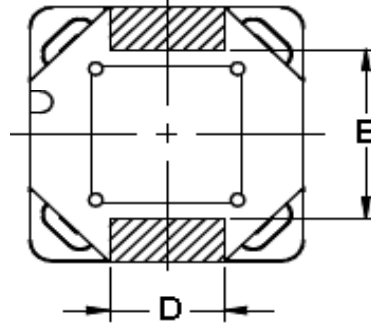
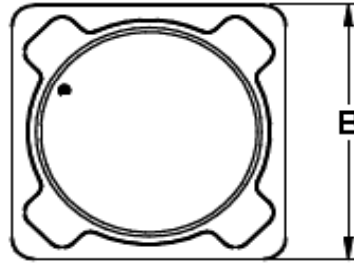
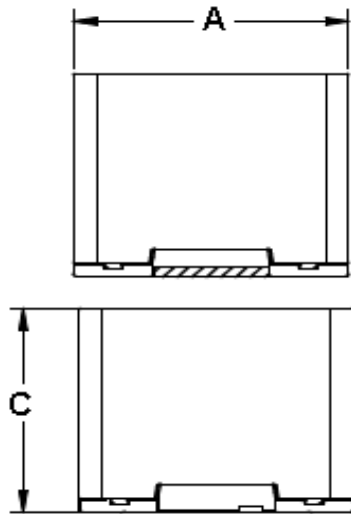

- A= 12,0 ± 0,3
- B= 12,0 ± 0,3
- C= 10,0 max
- D= 5,4 ± 0,2
- E= 6,8 ± 0,2

Ordering Information

Serie and Range	Tolerance	ROHS	Packing
S47006-221	M	R	TR
K = 10%	R = ROHS	BU = Bulk Ware	
M = 20%	N = non ROHS	TR = Tape Reel	

Soldering Profile for Lead Free Soldering 235-240°C

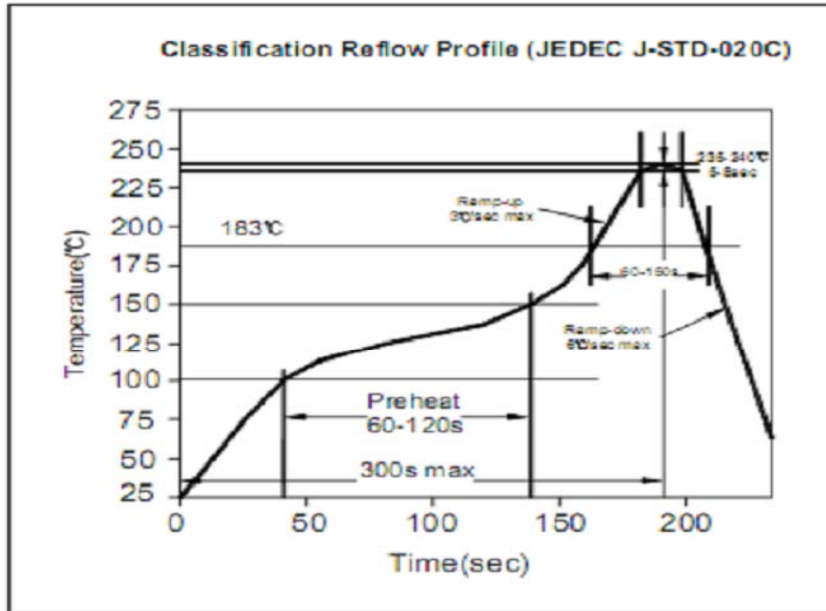

1. This electronic component is meant to be used in general electronic equipment. Before the incorporation of this component into any equipment with higher and more reliable requirements such as aviation, aerospace, submarine, nuclear control, transportation, transportation signal, disaster prevention, medical, public information network, etc. or if there is a possibility of injuries or damages to the human body, Edcon –Components must be informed before the stage of design-in. Evaluation checks for safety have to be performed on each electronic components used in electrical circuits that require high safety and reliability functions.

**SMT SHIELDED
 POWER INDUCTOR**

Part No.: **S47006-221**

Customer:

DRW:	Chang	CHKD	Young	MATL:	Chu Chi	DATE	05.06.2018
APPD:	Pong			FINISH	Vienna	Sheet	2 from 2

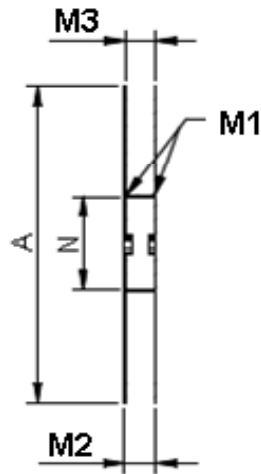
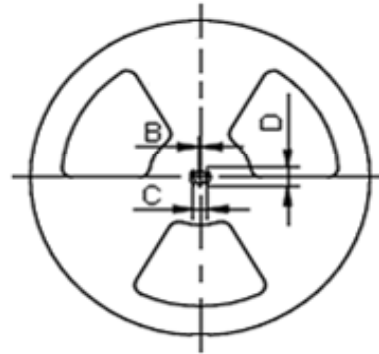
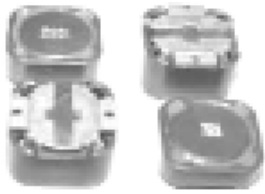

	Dimension (mm)								
	A	B	C	D	N	M1	M2	M3	M3
Tolerance	± 2.0	min.	min.	min.	± 2.0	+.2.0	max.	min.	max.
Tape width 24mm	330	1,5	12,8	20,2	60,0	24,4	30,4	23,9	27,4

<p>1. This electronic component is meant to be used in general electronic equipment. Before the incorporation of this component into any equipment with higher and more reliable requirements such as aviation, aerospace, submarine, nuclear control, transportation, transportation signal, disaster prevention, medical, public information network, etc. or if there is a possibility of injuries or damages to the human body, Edcon –Components must be informed before the stage of design-in. Evaluation checks for safety have to be performed on each electronic components used in electrical circuits that require high safety and reliability functions.</p>						SMT SHIELDED POWER INDUCTOR	
						Part No.: S47006-221	
						Customer:	
DRW:	Chang	CHKD	Young	MATL:	Chu Chi	DATE	05.06.2018
APPD:	Pong			FINISH	Vienna	Sheet	3 from 3