



# DATA SHEET

## SMD BCD ROTARY Switch

**Serie: Q28005**

<b>SMD BCD ROTARY Switch</b>	
Serie No.:	<b>Q28005</b>
Customer:	

DRW:	Jason	CHKD	Wilson	MATL:	Wilson	TOLERANCE	Mason	DATE	20.01.2023
APPD:	Schumi			FINISH	Jamy		Sheet No.	1 from 5	

# EDCON-COMPONENTS

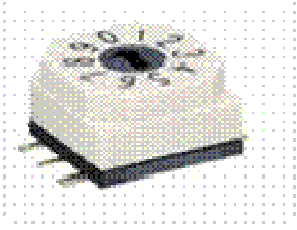

## Specifications

### Material

Housing/Knob: Thermoplastic (LCP) / PA66  
 O-Ring: Silicone Rubber  
 Terminal: Precise metal on phosphor bronze  
 Body Colour: Gray

### Mechanical:

Switching Positions: 10 / 16 Positions  
 Operating force: 700gr-cm max.  
 Life: 10.000detens

### Electrical:

Switching: 150mA, 24VDC  
 Non Switching: 200mA, 24VDC  
 Contact Resistance: 80mΩ max.  
 Insulation Resistance: 100M Ω at 100VDC  
 Withstanding Voltage: 250VAC / 1min.

### Environmental:

Operating Temperature: . -40°C to +85°C  
 Soldering Temperature: max. 250 ± 5°C for 5 seconds  
 Protection degree: IP67  
 Flammability Rating: UL94V-0

## Features

Fully Sealed construction  
 Gold Plated contacts  
 Molded-In terminals

**SMD BCD ROTARY Switch**

Part No.: **Q28005**

Customer:

DRW:	Jason	CHKD	Wilson	MATL:	Wilson	TOLERANCE	Mason	DATE	20.01.2023
APPD:	Schumi			FINISH	Jamy		Sheet No.		2 from 5

# EDCON-COMPONENTS

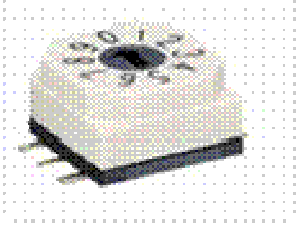

## Drawing

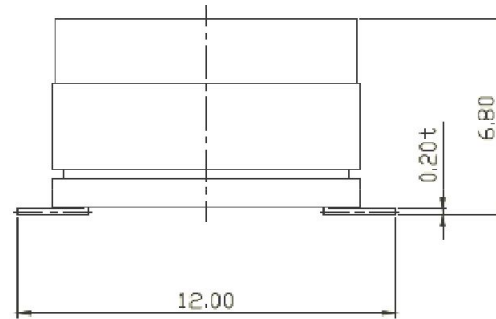
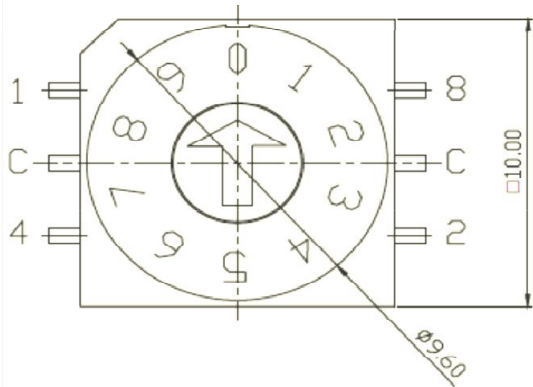

		Real Code				
		C	1	2	4	8
10 P o s i t i o n	0	●				
	1	●	●			
	2	●		●		
	3	●	●	●		
	4	●			●	
	5	●	●		●	
	6	●		●	●	
	7	●	●	●	●	
	8	●				●
	9	●	●			●
16 P o s i t i o n	A	●		●		●
	B	●	●	●		●
	C	●			●	●
	D	●	●		●	●
	E	●		●	●	●
	F	●	●	●	●	●

## PCB-Layout ( TOP-VIEW)

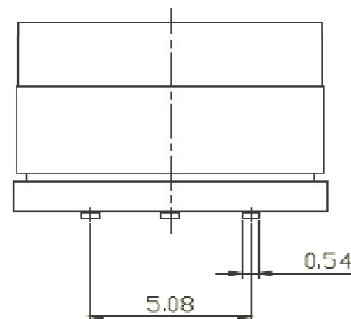
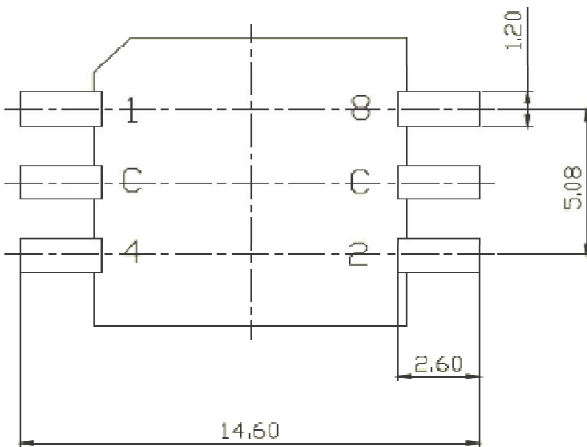

**SMD BCD ROTARY Switch**

Part No.: **Q28005**

Customer:

DRW:	Jason	CHKD	Wilson	MATL:	Wilson	TOLERANCE	Mason	DATE	20.01.2023
APPD:	Schumi			FINISH	Jamy		Sheet No.		3 from 5

# EDCON-COMPONENTS

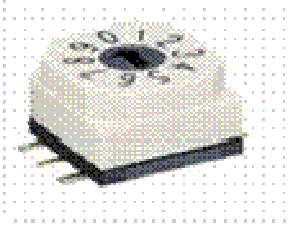

## Ordering Informations

Serie	BCD Order Code	Rotor Style	Terminal Style	ROHS	Packing Code					
<b>Q28005</b>	<b>10R</b>	<b>10</b>	<b>3</b>	<b>R</b>	<b>TU</b>					

<b>10R=</b> Type 10Real	<b>00=</b> Flat Knob Arrow Style	<b>3=</b> (3+3) Legs	<b>R=</b> ROHS Conform	<b>TU=</b> Tube Packing
<b>16R=</b> Type 16Real	<b>10=</b> Flat Knob Cross-Style		<b>N=</b> NON ROHS Conform	<b>TY=</b> Tray Packing
				<b>BU=</b> Bulk Ware

<b>SMD BCD ROTARY Switch</b>
Part No.: <b>Q28005</b>
Customer:

DRW:	Jason	CHKD	Wilson	MATL:	Wilson	TOLERANCE	Mason	DATE	20.01.2023
APPD:	Schumi			FINISH	Jamy		Sheet No.		4 from 5

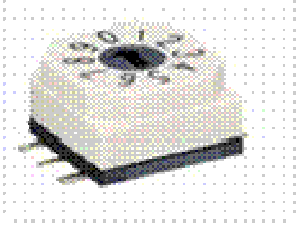

Soldering Profile Curve

Classification Reflow Profile (JEDEC J-STD-020C)

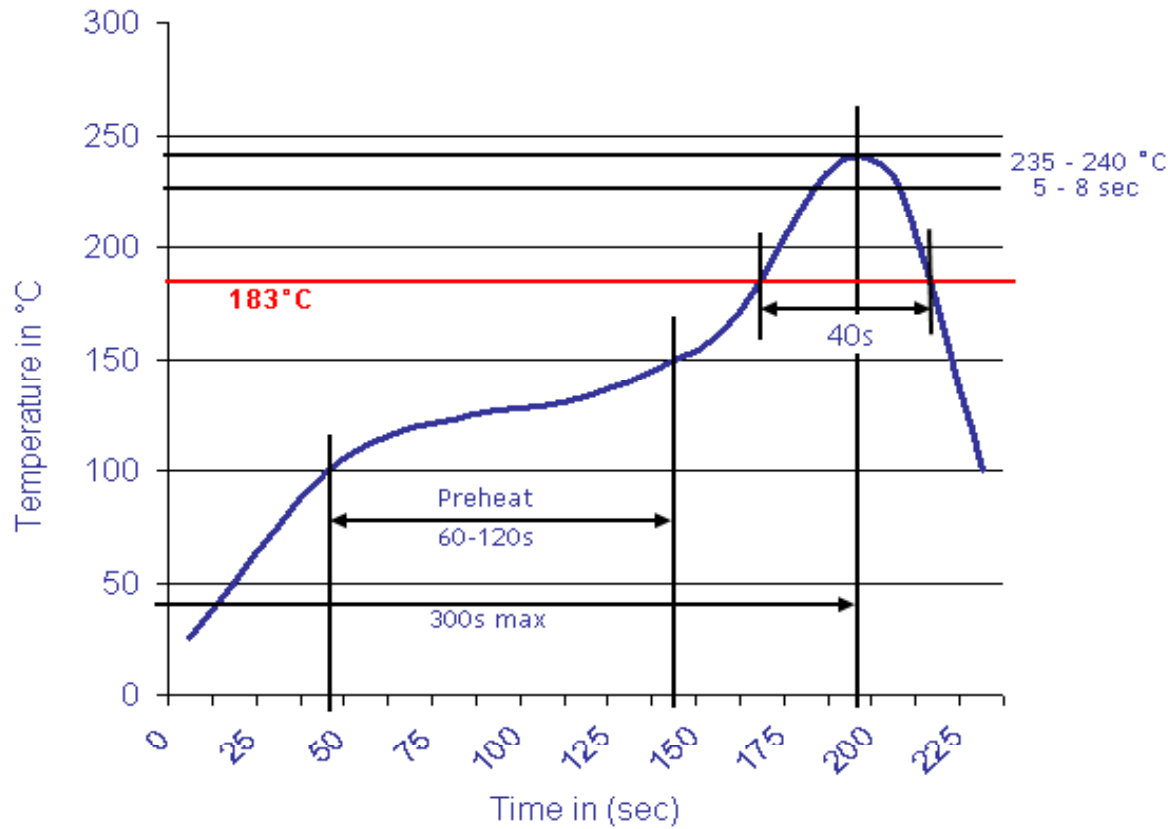

<b>SMD BCD ROTARY Switch</b>	
Part No.:	<b>Q28005</b>
Customer:	

DRW:	Jason	CHKD	Wilson	MATL:	Wilson	TOLERANCE	Mason	DATE	20.01.2023
APPD:	Schumi			FINISH	Jamy		Sheet No.		5 from 5