

# EDCON-COMPONENTS

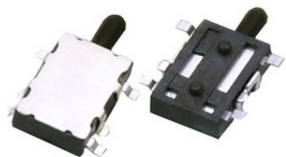

## SPECIFICATION:

Voltage Rating:	12VDC
Current Rating:	50mA
Mechanical Life:	500000 cycles
Contact Resistance:	<200m Ω max. (initial)
Insulation Resistance:	>100M Ω min. 500VDC
Dielectric Strength:	100VAC/1min.
Operating Temperature:	.-10°C ~ +60°C
Operating Force:	look Ordering Code
Switch function:	OFF-(ON)

## Drawing / Dimensions (mm)

### PCB-Layout TOP VIEW

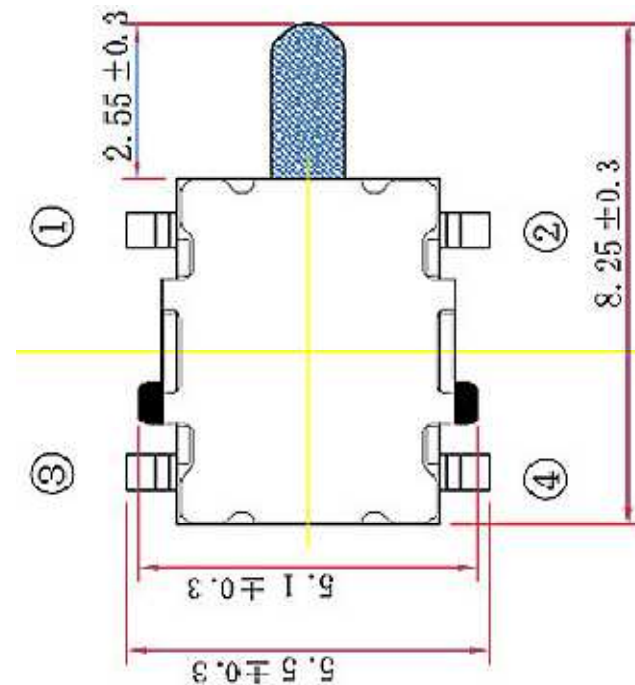
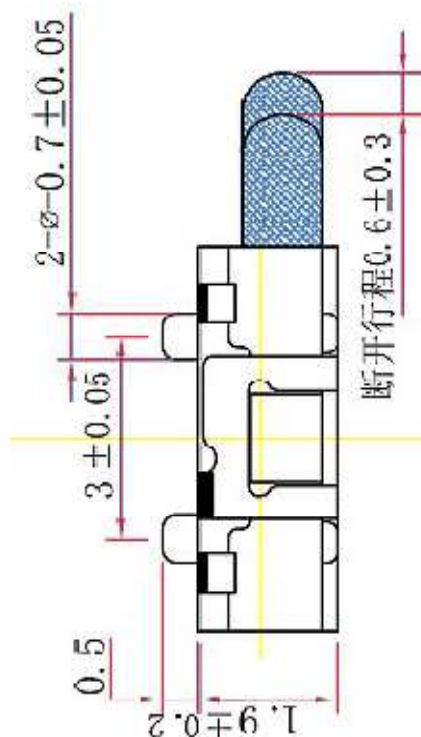
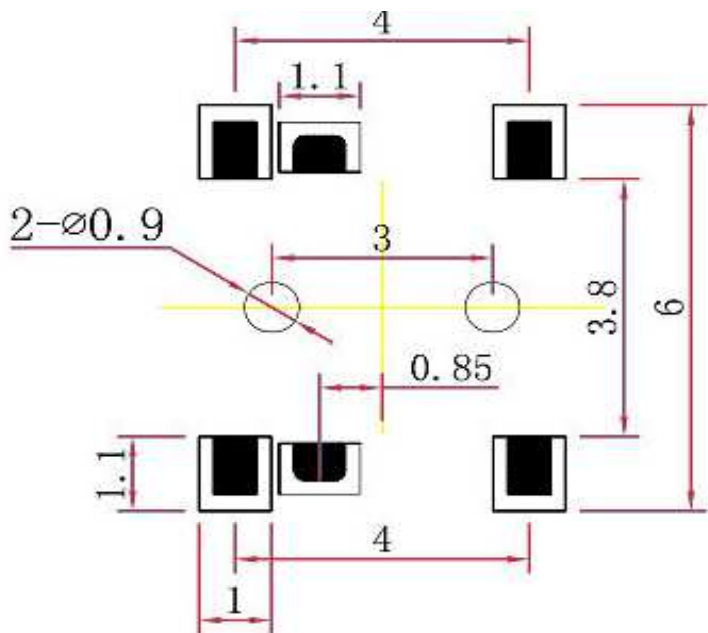

Tolerances unless otherwise specified (mm)

x	x.x	x.xx	x.xxx	Angle
±	±	±	±	±3°
DRW:	Jason	CHKD	Wilson	MATL:
APPD:	Schumi			FINISH
				Wilson
				Jamy
				Mason
				DATE
				18.04.2021
				Sheet No.
				1 from 4

## SMT Detector Switch

Part No.: **Q22079**

Customer:

# EDCON-COMPONENTS

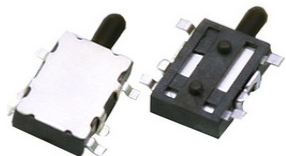

## Circuit

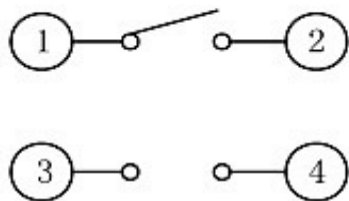

## Drawing / Dimensions (mm)

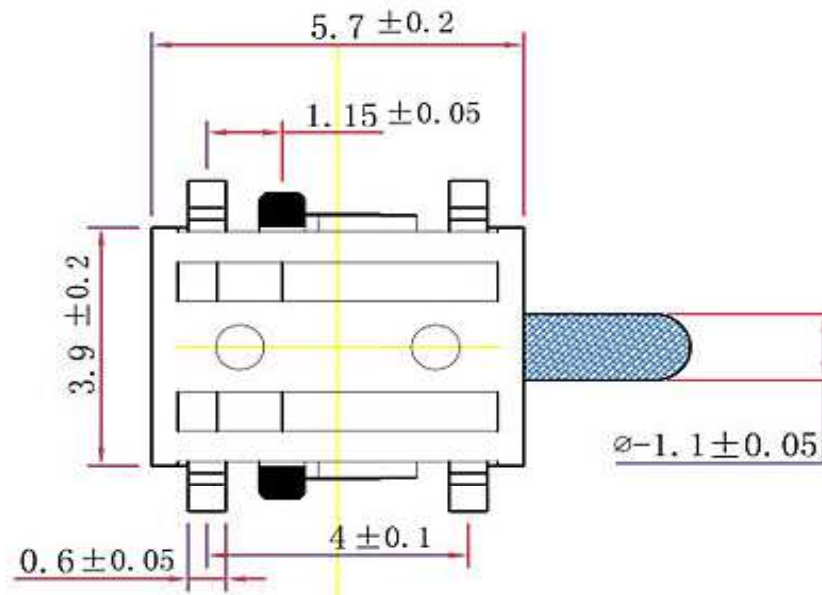

### SMT Detector Switch

Part No.: **Q22079**

Customer:

DRW:	Jason	CHKD	Wilson	MATL:	Wilson	TOLERANCE	Mason	DATE	18.04.2021
APPD:	Schumi			FINISH	Jamy		Sheet No.	2 from 4	

# EDCON-COMPONENTS

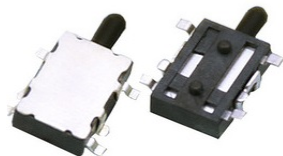

## Ordering Informations

Serie	Total height w. Body	Fill with 0	Operating Force	Polarisation Peg	Electrical life	Cap Option	Cap Colour	Special function	ROHS	Packing
<b>Q22079</b>	<b>019</b>	<b>X</b>	<b>080</b>	<b>Y</b>	<b>503</b>	<b>N</b>	<b>N</b>	<b>N</b>	<b>R</b>	<b>TR</b>
	<b>032= 3,2mm</b>	<b>X= no function</b>	<b>080= 80gr</b>	<b>N= without Peg</b> <b>Y= with Peg</b>	<b>503= 50000 Cycles</b>	<b>N= No Cap option</b>	<b>N= No Cap Option</b>	<b>N= No Function</b>	<b>N= Non ROHS</b> <b>R= ROHS conform</b>	<b>TR = Tape/Reel Packing</b> <b>TU= Tube Packing</b> <b>BU= Bulk Ware</b>

**SMT Detector Switch**

Part No.: **Q22079**

Customer:

DRW:	Jason	CHKD	Wilson	MATL:	Wilson	TOLERANCE	Mason	DATE	18.04.2021
APPD:	Schumi			FINISH	Jamy		Sheet No.		3 from 4

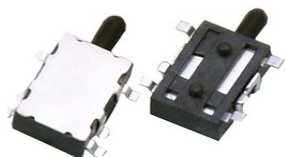

Soldering Profile Lead Free Curve

Classification Reflow Profile (JEDEC J-STD-020C)

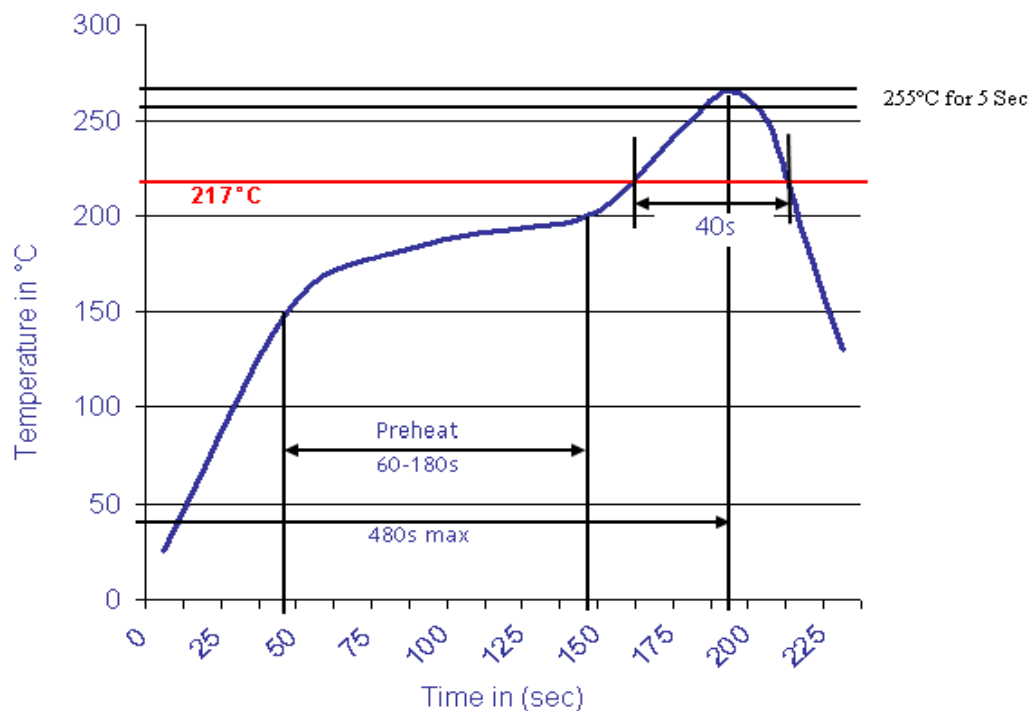

**SMT Detector Switch**

Part No.: **Q22079**

Customer:

DRW:	Jason	CHKD	Wilson	MATL:	Wilson	TOLERANCE	Mason	DATE	18.04.2021
APPD:	Schumi			FINISH	Jamy		Sheet No.	4 from 4	