

EDCON-COMPONENTS



SPECIFICATION:

Rated Voltage:	DC48V / AC125V
Rated Current:	0,1A / 0,1A
Contact Resistance:	≤ 300mΩ
Operating Force:	70gr +/- 20gf
Resilience:	RF
Free Position:(FP)	3,5 ± 0,3mm
Action Position:(OP)	3,3 ± 0,3mm
Return Position (RP)	
Stroke:	PT
Sensitivity:	BT ≤5ms
Mechanical:	
Mechanical Life:	3.000.000 cycles,
Electrical Life:	3.000.000 cycles,
Applicable Temperature:	-.25°C + 80°C
Insulation Resistance:	≥100MΩ DC250V
	Applicable Humidity <85% RH
Withstanding Voltage:	AC 250V 1 minute

Drawing / Dimension (mm)

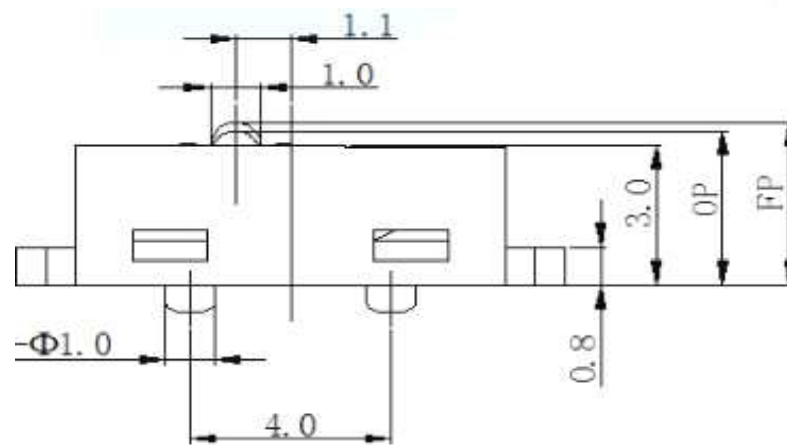
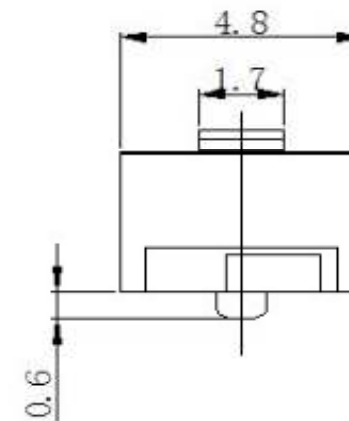
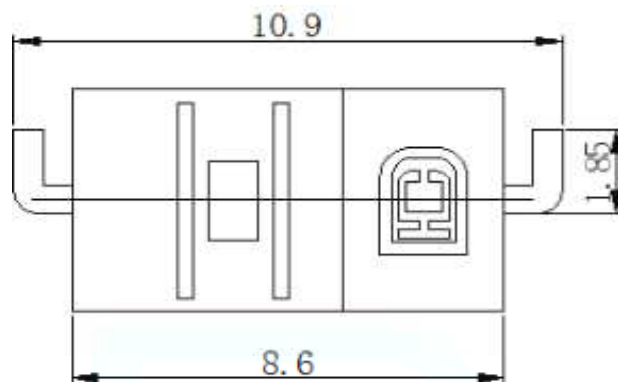

PCB-Layout

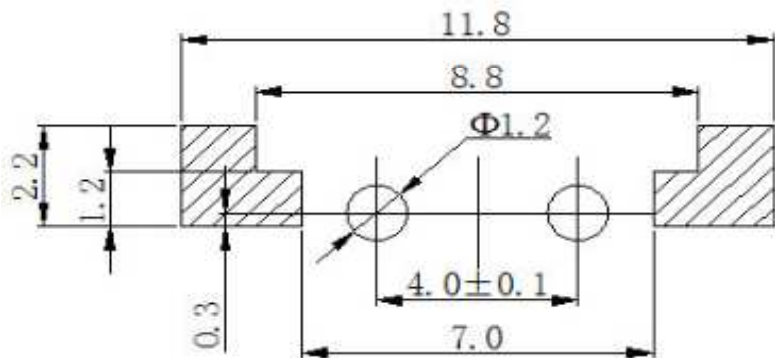

CIRCUIT DIAGRAM

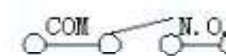

Tolerances unless otherwise specified (mm)				
x	x.x	x.xx	x.xxx	Angle
±	±	±	±	±3°
DRW:	Jason	CHKD	Wilson	MATL:
APPD:	Schumi			FINISH
Wilson	TOLERANCE	Mason	DATE	14.11.2021
Jamy		Sheet No.		1 from 5

Mikro SWITCH	
10,9x4,8mm	
Part No.:	Q19060
Customer:	



Structure Chart

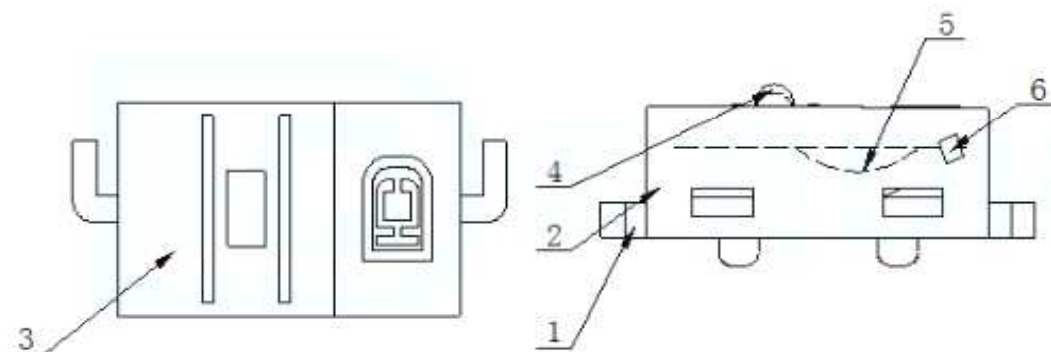

- | | |
|-----|----------------|
| NO. | 品名 |
| 1 | Terminal端子 |
| 2 | Base底座 |
| 3 | Case上盖 |
| 4 | Button按钮 |
| 5 | Spring Plate弹片 |
| 6 | Contact接点 |

Mikro SWITCH 10,9x4,8mm	
Part No.:	Q19060
Customer:	

DRW:	Jason	CHKD	Wilson	MATL:	Wilson	TOLERANCE	Mason	DATE	14.11.2021
APPD:	Schumi			FINISH	Jamy		Sheet No.		3 from 5

EDCON-COMPONENTS



Ordering Informations

Serie	Switch Type	Lever Style Code (Ax)	Operating force (Bx)	Special function	Special function	ROHS	Packing
Q19060	1	A0	Bx	C0	D0	R	BU

1= 0,1A/ DC48 / AC125V		B0= 70gr	C0= No function	D0= No function	R= ROHS conform	BU= Bulk Ware
		B1= 30gr			N= Non ROHS	TY= Tray Packing
						IV= Individual Packing

Order Code	Operating Force (gf)	
	OF	
B0	70	±20gf
B1	30	±15gf

Mikro SWITCH 10,9x4,8mm	
Part No.:	Q19060
Customer:	

DRW:	Jason	CHKD	Wilson	MATL:	Wilson	TOLERANCE	Mason	DATE	14.11.2021
APPD:	Schumi			FINISH	Jamy		Sheet No.		4 from 5



Soldering Profile for Lead Free Soldering

Soldering Profile for Reflow Soldering

Classification Reflow Profile (JEDEC J-STD-020C)

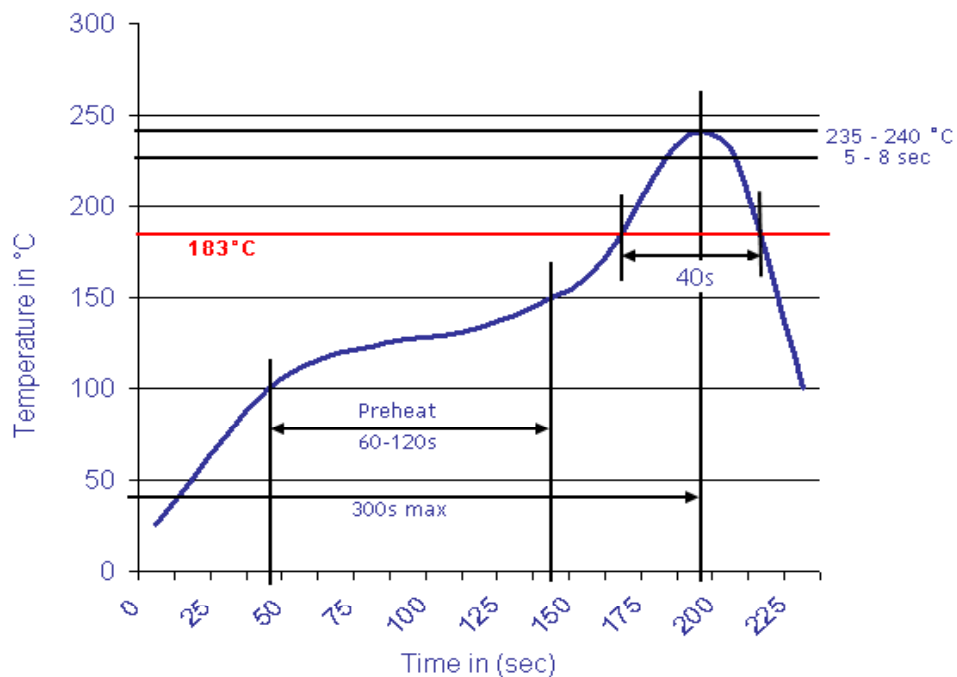

**Mikro SWITCH
10,9x4,8mm**

Part No.: **Q19060**

Customer:

DRW:	Jason	CHKD	Wilson	MATL:	Wilson	TOLERANCE	Mason	DATE	14.11.2021
APPD:	Schumi			FINISH	Jamy		Sheet No.	5 from 5	