

EDCON-COMPONENTS



SPECIFICATION:

Rated Voltage:	125 / 250VAC
Rated Current:	10A/125//250VAC
Contact Resistance:	≤ 100mΩ / DC500V
Operating Force:	
Resilience:	RF
Free Position:(FP)	14,6 ± 1,2mm
Action Position:(OP)	13,0 ± 1,2mm
Return Position (RP)	
Stroke:	PT
Sensitivity:	BT
Mechanical:	
Mechanical Life:	1.000.000 cycles, 2,5 Welding Process Manual Welding
Electrical Life:	10.000 cycles
Applicable Temperature:	.-25°C + 85°C
Insulation Resistance:	≥100MΩ DC500V Applicable Humidity <85% RH
Withstanding Voltage:	AC 1500V 1 minute

Drawing / Dimension (mm)

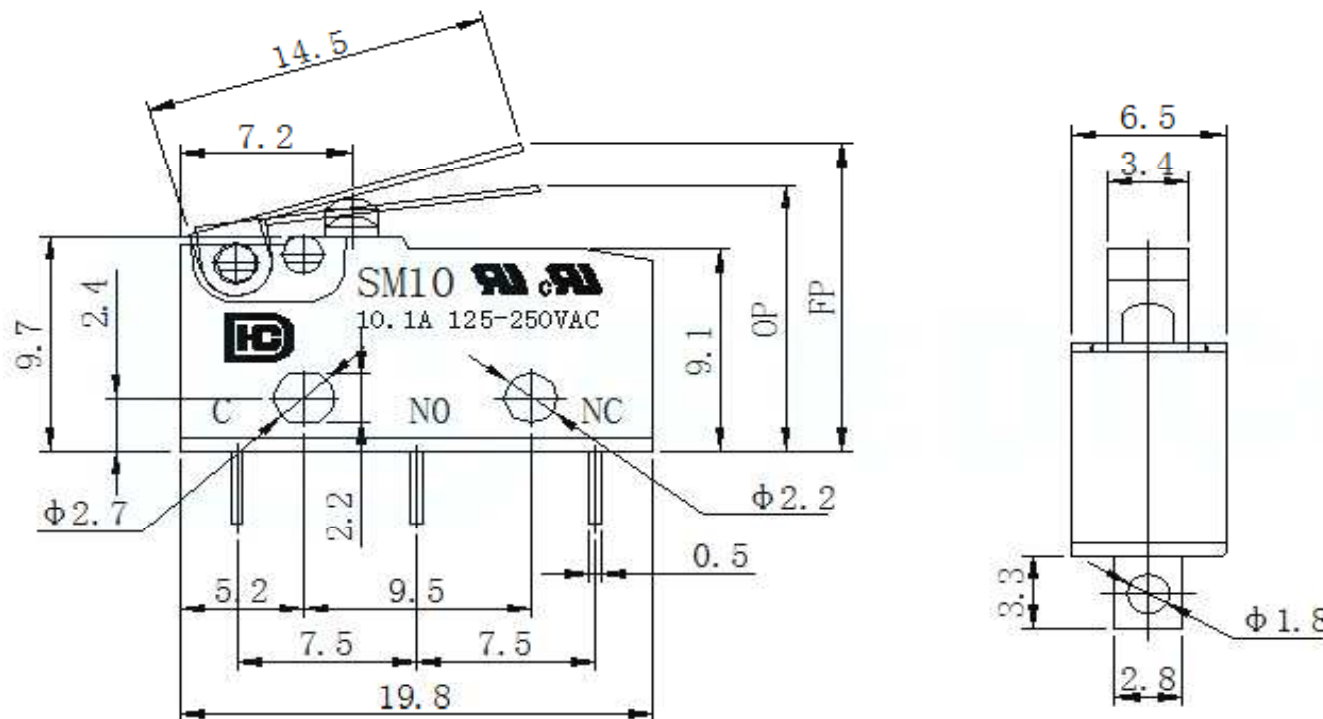

SCHEMATIC

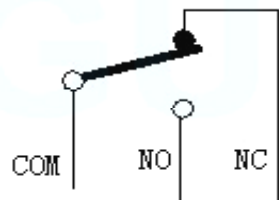

Tolerances unless otherwise specified (mm)				
x	x.x	x.xx	x.xxx	Angle
±	±	±	±	±3°

THT Mikro SWITCH	
19,8x10,6mm	
Part No.:	Q19051
Customer:	

DRW:	Jason	CHKD	Wilson	MATL:	Wilson	TOLERANCE	Mason	DATE	13.11.2021
APPD:	Schumi			FINISH	Jamy		Sheet No.		1 from 4

EDCON-COMPONENTS



Lever Style (Ax)

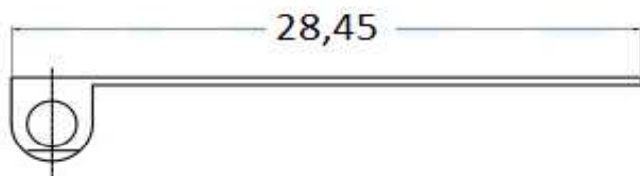

Order Code = A1

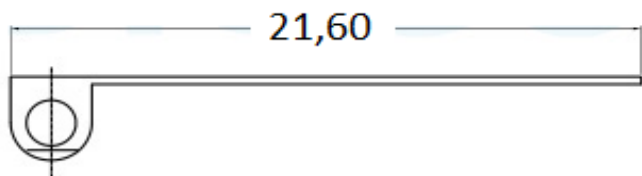

Order Code = A2

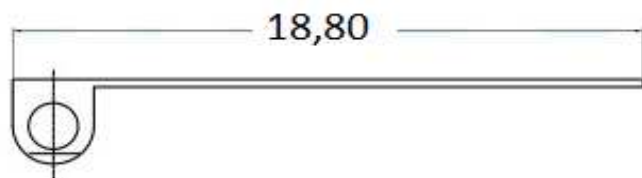

Order Code = A3

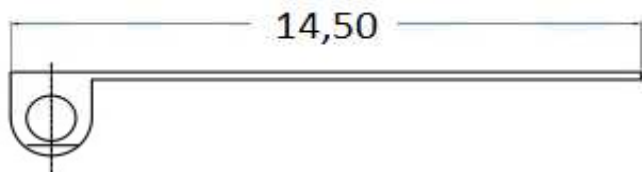

Order Code = A4



Order Code = A5

Order Code	Operating Force (gf)		
	OF		
B0	150		
B1	175		
B2	190		
B3	220		
B4	250		

THT Mikro SWITCH
19,8x10,6mm

Part No.: **Q19051**

DRW:	Jason	CHKD	Wilson	MATL:	Wilson	TOLERANCE	Mason	DATE	13.11.2021	Customer:
APPD:	Schumi			FINISH	Jamy		Sheet No.	2 from 4		

EDCON-COMPONENTS



Ordering Informations

Serie	Switch Type	Lever Style Code (Ax)	Operating force (Bx)	Special function	Special function	ROHS	Packing
Q19051	1	A0	Bx	C0	D0	R	BU

1= 10A/125/250VAC	A0= without Lever	B0= 150gr	C0= No function	D0= No function	R= ROHS conform	BU= Bulk Ware
	A1= Type A1	B1= 175gr			N= Non ROHS	TY= Tray Packing
	A2= Type A2	B2= 190gr				
	A3= Type A3	B3= 220gr				
	A4= Type A4	B3= 250gr				IV= Individual Packing
	A5= Type A5					

**THT Mikro SWITCH
19,8x10,6mm**

Part No.: **Q19051**

Customer:

DRW:	Jason	CHKD	Wilson	MATL:	Wilson	TOLERANCE	Mason	DATE	13.11.2021
APPD:	Schumi			FINISH	Jamy		Sheet No.		3 from 4



Soldering Profile for Lead Free Soldering

Soldering Profile for Reflow Soldering

Classification Reflow Profile (JEDEC J-STD-020C)

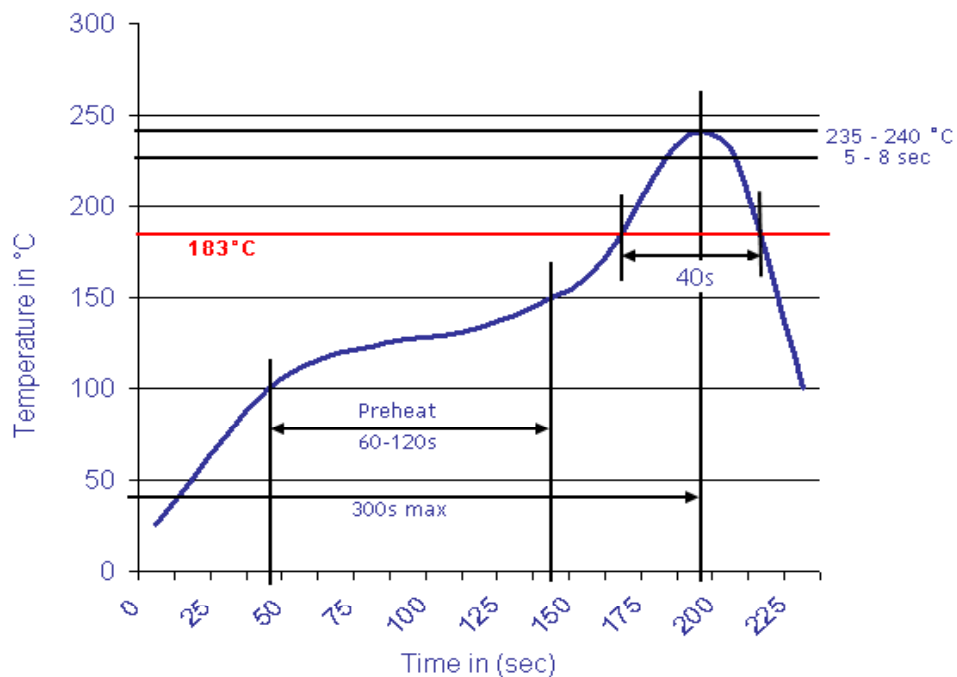

**THT Mikro SWITCH
19,8x10,6mm**

Part No.: **Q19051**

DRW:	Jason	CHKD	Wilson	MATL:	Wilson	TOLERANCE	Mason	DATE	13.11.2021
APPD:	Schumi			FINISH	Jamy		Sheet No.	4 from 4	Customer: