

# EDCON-COMPONENTS



## SPECIFICATION:

Rated Voltage:	125 / 250VAC
Rated Current:	10A/125//250VAC
Contact Resistance:	≤ 100mΩ / DC500V
Operating Force:	
Resilience:	RF
Free Position:(FP)	11,4 ± 0,5mm
Action Position:(OP)	10,8 ± 0,5mm
Return Position (RP)	
Stroke:	PT
Sensitivity:	BT
Mechanical:	
Mechanical Life:	1.000.000 cycles, 2,5 Welding Process Manual Welding
Electrical Life:	10.000 cycles
Applicable Temperature:	-.25°C + 85°C
Insulation Resistance:	≥100MΩ DC500V Applicable Humidity <85% RH
Withstanding Voltage:	AC 1500V 1 minute

## Drawing / Dimension (mm)

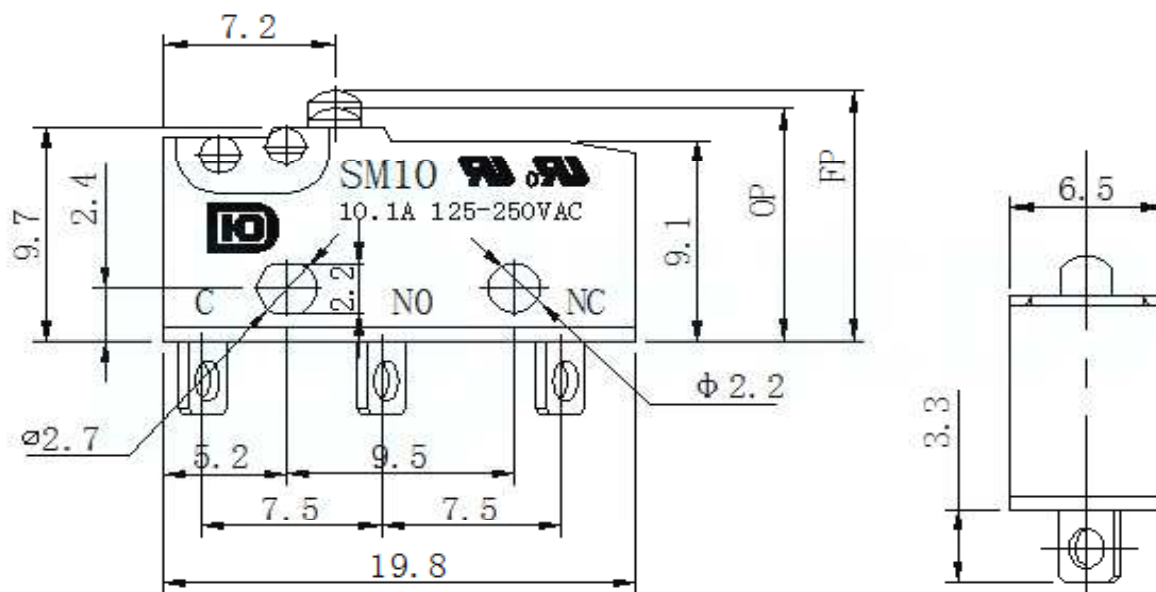

## SCHEMATIC

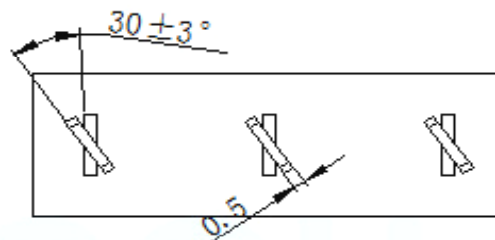
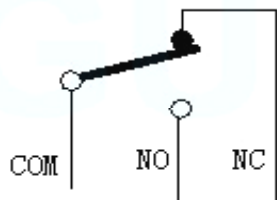

Tolerances unless otherwise specified (mm)				
x	x.x	x.xx	x.xxx	Angle
±	±	±	±	±3°
DRW:	Jason	CHKD	Wilson	MATL:
APPD:	Schumi			FINISH
				Jamy
				Mason
				DATE
				13.11.2021
				Sheet No.
				1 from 4

<b>THT Mikro SWITCH</b>	
<b>19,8x10,6mm</b>	
Part No.:	<b>Q19042</b>
Customer:	

# EDCON-COMPONENTS



## Lever Style (Ax)

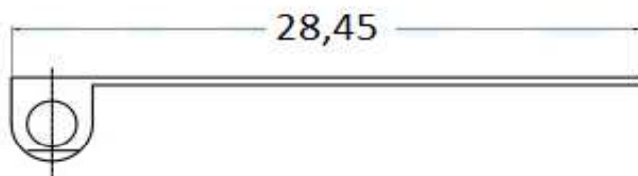

Order Code = A1

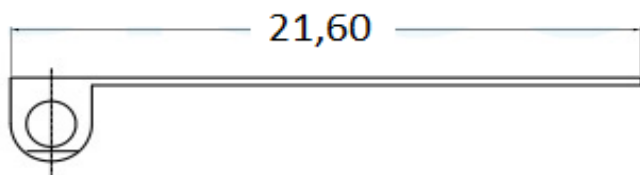

Order Code = A2

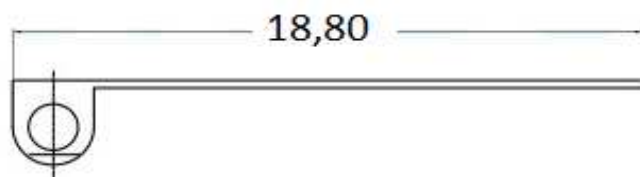

Order Code = A3

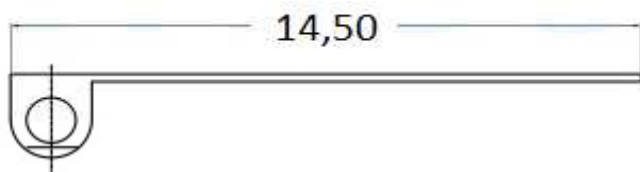

Order Code = A4



Order Code = A5

Order Code	Operating Force (gf)		
	OF		
B0	150		
B1	175		
B2	190		
B3	220		
B4	250		

**THT Mikro SWITCH**  
**19,8x10,6mm**

Part No.: **Q19042**

Customer:

DRW:	Jason	CHKD	Wilson	MATL:	Wilson	TOLERANCE	Mason	DATE	13.11.2021
APPD:	Schumi			FINISH	Jamy		Sheet No.		2 from 4

[www.edcon-components.com](http://www.edcon-components.com)

email: [info@edcon-components.com](mailto:info@edcon-components.com)

# EDCON-COMPONENTS



## Ordering Informations

Serie	Switch Type	Lever Style Code (Ax)	Operating force (Bx)	Special function	Special function	ROHS	Packing
<b>Q19042</b>	<b>1</b>	<b>A0</b>	<b>Bx</b>	<b>C0</b>	<b>D0</b>	<b>R</b>	<b>BU</b>

<b>1= 10A/125/250VAC</b>	<b>A0= without Lever</b>	<b>B0= 150gr</b>	<b>C0= No function</b>	<b>D0= No function</b>	<b>R= ROHS conform</b>	<b>BU= Bulk Ware</b>
	<b>A1= Type A1</b>	<b>B1= 175gr</b>			<b>N= Non ROHS</b>	<b>TY= Tray Packing</b>
	<b>A2= Type A2</b>	<b>B2= 190gr</b>				
	<b>A3= Type A3</b>	<b>B3= 220gr</b>				
	<b>A4= Type A4</b>	<b>B3= 250gr</b>				<b>IV= Individual Packing</b>
	<b>A5= Type A5</b>					

<b>THT Mikro SWITCH 19,8x10,6mm</b>	
Part No.:	<b>Q19042</b>
Customer:	

DRW:	Jason	CHKD	Wilson	MATL:	Wilson	TOLERANCE	Mason	DATE	13.11.2021
APPD:	Schumi			FINISH	Jamy		Sheet No.		3 from 4



Soldering Profile for Lead Free Soldering

Soldering Profile for Reflow Soldering

## Classification Reflow Profile (JEDEC J-STD-020C)

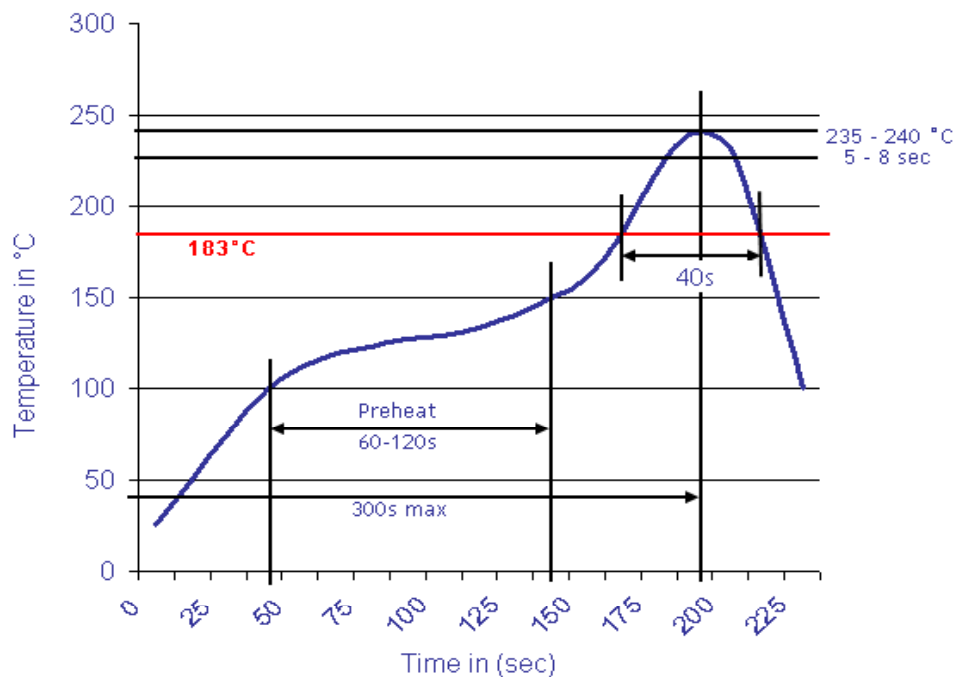

**THT Mikro SWITCH**  
**19,8x10,6mm**

Part No.: **Q19042**

DRW:	Jason	CHKD	Wilson	MATL:	Wilson	TOLERANCE	Mason	DATE	13.11.2021
APPD:	Schumi			FINISH	Jamy		Sheet No.	4 from 4	Customer: