

EDCON-COMPONENTS



SPECIFICATION:

Rated Voltage: 125/250VAC
 Rated Current: 5A
 Contact Resistance: ≤ 100mΩ
 Operating Force: 115 ± 30gf
 Resilience: RF
 Free Position: 11,9 ± 0,3mm
 Action Position: 11,3 ± 0,35mm
 Return Position: RP
 Stroke: PT
 Sensitivity: BT

Mechanical:
 Mechanical Life: 1.000.000 cycles,
 2,5 Welding Process Manual Welding
 Electrical Life: 10.000 cycles
 2.6 Applicable Temperature: -25°C + 85°C
 Insulation Resistance: ≥100MΩ DC500V
 Applicable Humidity <85% RH
 Compressive Strength: AC 1000V 1 minute

Drawing / Dimension (mm)

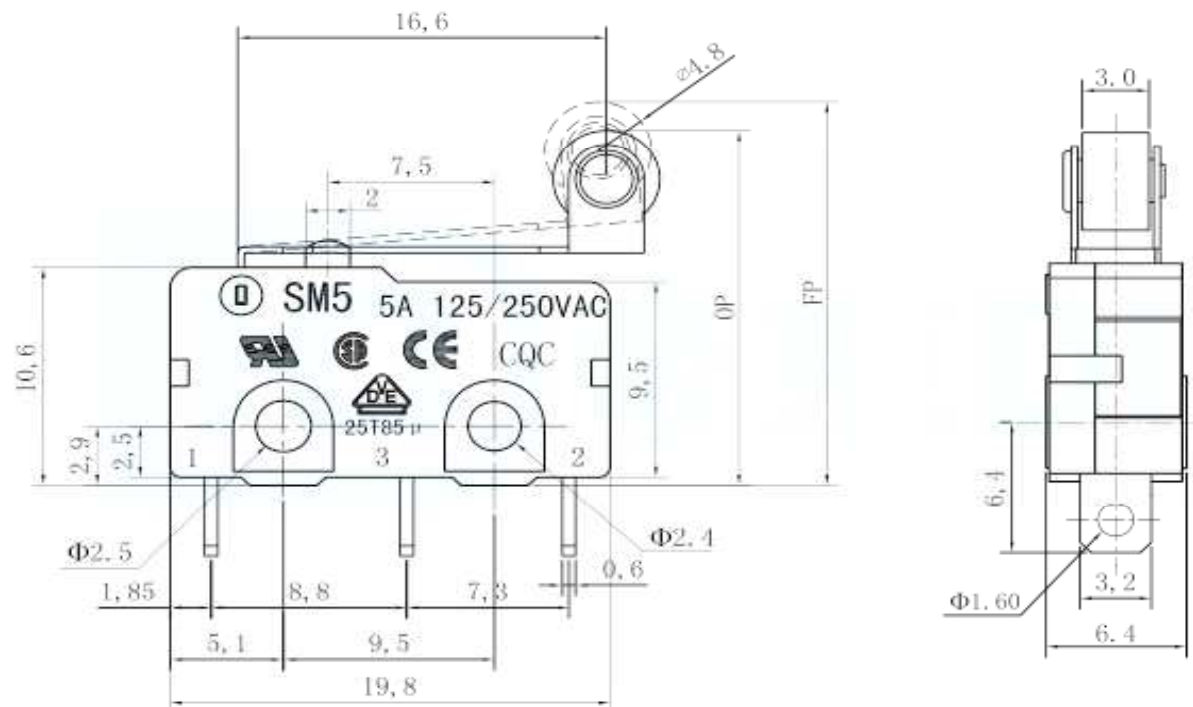

SCHEMATIC

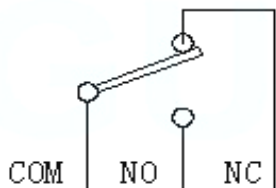

Tolerances unless otherwise specified (mm)				
x	x.x	x.xx	x.xxx	Angle
±	±	±	±	±3°

THT Mikro SWITCH	
19,8x10,6mm	
Part No.:	Q19027
Customer:	

DRW:	Jason	CHKD:	Wilson	MATL:	Wilson	TOLERANCE:	Mason	DATE:	13.11.2021
APPD:	Schumi	FINISH:	Jamy	Sheet No.:			1 from 4		

EDCON-COMPONENTS



Lever Style (Ax)

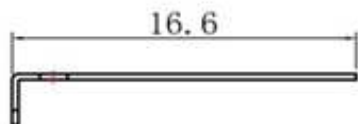

Order Code = A1

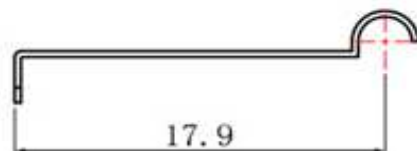

Order Code = A4

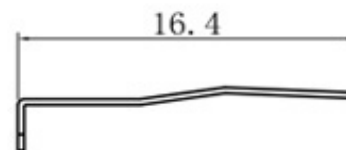

Order Code = Bx

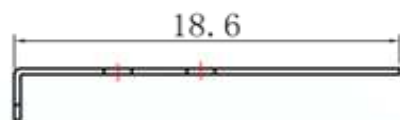

Order Code = A2

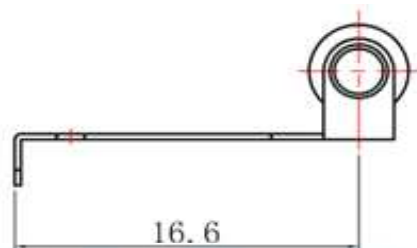

Order Code = A5

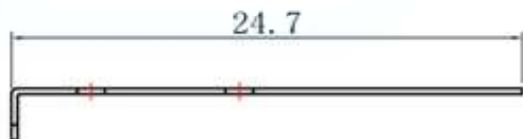

Order Code = A3

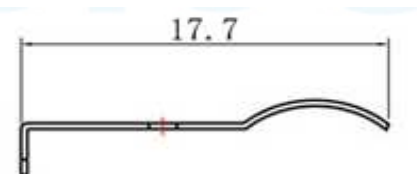

Order Code = A6

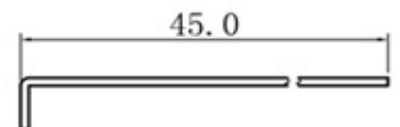

Order Code = A7

Order Code	Operating Force (gf)		
	BT	RP	PT
B0	115	175	250
B1	30	45	60
B2	25	38	55
B3	18	28	45
B4	28	40	60
B5	30	45	68
B6	38	55	75
B7	14	20	25

**THT Mikro SWITCH
19,8x10,6mm**

Part No.: **Q19027**

Customer:

DRW:	Jason	CHKD	Wilson	MATL:	Wilson	TOLERANCE	Mason	DATE	13.11.2021
APPD:	Schumi			FINISH	Jamy		Sheet No.		2 from 4

EDCON-COMPONENTS

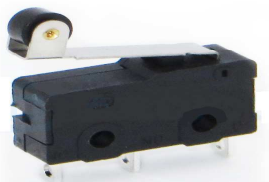

Ordering Informations

Serie	Lever Style Code (Ax)	Operating force (Bx)	Special function	Special function	ROHS	Packing
-------	-----------------------	----------------------	------------------	------------------	------	---------

Q19027	A0	Bx	C0	D0	R	BU
---------------	-----------	-----------	-----------	-----------	----------	-----------

A0 = without Lever	B0 = 175gr	C0 = No function	D0 = No function	R = ROHS conform	BU = Bulk Ware
A1 = Type A1	B1 = 45gr			N = Non ROHS	TY = Tray Packing
A2 = Type A2	B2 = 38gr				
A3 = Type A3	B3 = 28gr				
A4 = Type A4	B4 = 40gr				IV = Individual Packing
A5 = Type A5	B5 = 45gr				
A6 = Type A6	B6 = 55gr				
A7 = Type A7	B7 = 20gr				
A8 = Type A8					

**THT Mikro SWITCH
19,8x10,6mm**

Part No.: **Q19027**

Customer:

DRW:	Jason	CHKD	Wilson	MATL:	Wilson	TOLERANCE	Mason	DATE	13.11.2021
APPD:	Schumi			FINISH	Jamy		Sheet No.		3 from 4



Soldering Profile for Lead Free Soldering

Soldering Profile for Reflow Soldering

Classification Reflow Profile (JEDEC J-STD-020C)



**THT Mikro SWITCH
19,8x10,6mm**

Part No.: **Q19027**

DRW:	Jason	CHKD	Wilson	MATL:	Wilson	TOLERANCE	Mason	DATE	13.11.2021
APPD:	Schumi			FINISH	Jamy		Sheet No.	4 from 4	

Customer: