

# EDCON-COMPONENTS

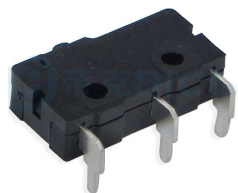

## SPECIFICATION:

Rated Voltage:	125/250VAC
Rated Current:	5A
Contact Resistance:	≤ 100mΩ
Operating Force:	115 ± 30gf
Resilience:	RF
Free Position:	11,9 ± 0,3mm
Action Position:	11,3 ± 0,35mm
Return Position:	RP
Stroke:	PT
Sensitivity:	BT
Mechanical:	
Mechanical Life:	1.000.000 cycles, 2,5 Welding Process Manual Welding
Electrical Life:	10.000 cycles
Insulation Resistance:	2.6 Applicable Temperature: -25°C + 85°C ≥100MΩ DC500V
Compressive Strength:	Applicable Humidity <85% RH AC 1000V 1 minute

## Drawing / Dimension (mm)

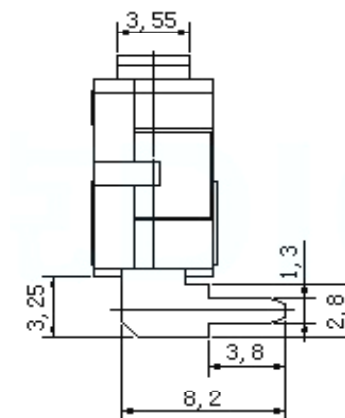
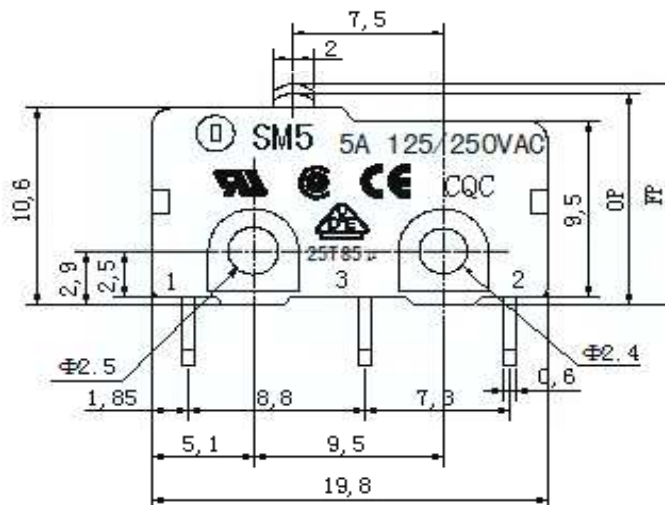

## SCHEMATIC

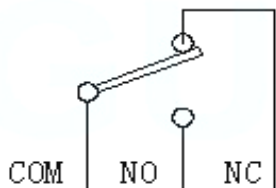

Tolerances unless otherwise specified (mm)				
x	x.x	x.xx	x.xxx	Angle
±	±	±	±	±3°
DRW:	Jason	CHKD	Wilson	MATL:
APPD:	Schumi			FINISH
				Jamy
				Sheet No.
				1 from 4

<b>THT Mikro SWITCH</b>	
<b>19,8x10,6mm</b>	
Part No.:	<b>Q19019</b>
Customer:	

# EDCON-COMPONENTS



## Lever Style (Ax)

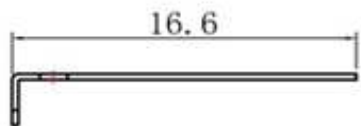

Order Code = A1

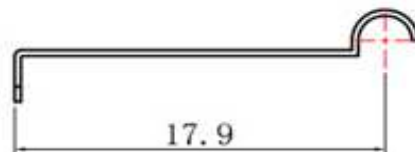

Order Code = A4

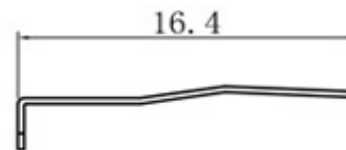

Order Code = Bx

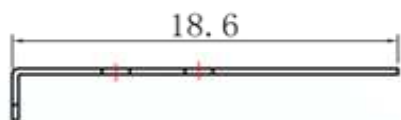

Order Code = A2

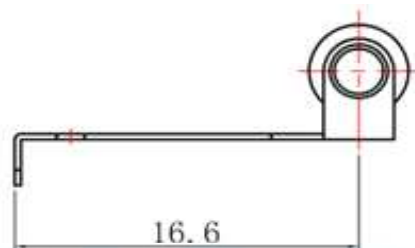

Order Code = A5

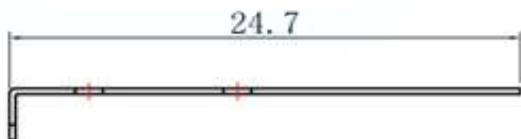

Order Code = A3

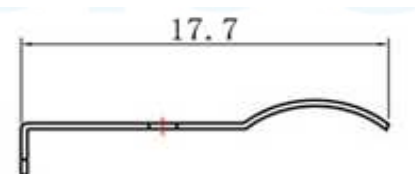

Order Code = A6

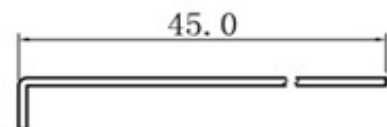

Order Code = A7

Order Code	Operating Force (gf)		
	BT	RP	PT
<b>B0</b>	115	175	250
<b>B1</b>	30	45	60
<b>B2</b>	25	38	55
<b>B3</b>	18	28	45
<b>B4</b>	28	40	60
<b>B5</b>	30	45	68
<b>B6</b>	38	55	75
<b>B7</b>	14	20	25

**THT Mikro SWITCH  
19,8x10,6mm**

Part No.: **Q19019**

Customer:

DRW:	Jason	CHKD	Wilson	MATL:	Wilson	TOLERANCE	Mason	DATE	13.11.2021
APPD:	Schumi			FINISH	Jamy		Sheet No.		2 from 4

# EDCON-COMPONENTS



## Ordering Informations

Serie	Lever Style Code (Ax)	Operating force (Bx)	Special function	Special function	ROHS	Packing
-------	-----------------------	----------------------	------------------	------------------	------	---------

<b>Q19019</b>	<b>A0</b>	<b>Bx</b>	<b>C0</b>	<b>D0</b>	<b>R</b>	<b>BU</b>
---------------	-----------	-----------	-----------	-----------	----------	-----------

<b>A0</b> = without Lever	<b>B0</b> = 175gr	<b>C0</b> = No function	<b>D0</b> = No function	<b>R</b> = ROHS conform	<b>BU</b> = Bulk Ware
<b>A1</b> = Type A1	<b>B1</b> = 45gr			<b>N</b> = Non ROHS	<b>TY</b> = Tray Packing
<b>A2</b> = Type A2	<b>B2</b> = 38gr				
<b>A3</b> = Type A3	<b>B3</b> = 28gr				
<b>A4</b> = Type A4	<b>B4</b> = 40gr				<b>IV</b> = Individual Packing
<b>A5</b> = Type A5	<b>B5</b> = 45gr				
<b>A6</b> = Type A6	<b>B6</b> = 55gr				
<b>A7</b> = Type A7	<b>B7</b> = 20gr				
<b>A8</b> = Type A8					

**THT Mikro SWITCH  
19,8x10,6mm**

Part No.: **Q19019**

Customer:

DRW:	Jason	CHKD	Wilson	MATL:	Wilson	TOLERANCE	Mason	DATE	13.11.2021
APPD:	Schumi			FINISH	Jamy		Sheet No.		3 from 4



Soldering Profile for Lead Free Soldering

Soldering Profile for Reflow Soldering

## Classification Reflow Profile (JEDEC J-STD-020C)



**THT Mikro SWITCH**  
**19,8x10,6mm**

Part No.: **Q19019**

DRW:	Jason	CHKD	Wilson	MATL:	Wilson	TOLERANCE	Mason	DATE	13.11.2021
APPD:	Schumi			FINISH	Jamy		Sheet No.	4 from 4	Customer: