

EDCON-COMPONENTS



Technical Informations

Material: Nylon 66
 Flame Class: 94V-2 / V0
 Color: Natural
 Temperature Range: -40°C ~ +85°C

Hole Diameter

Hole 1 (+/-0,08mm) 4,0mm
 Panel Thickness Hole 1 1,6mm
 Hole 2 (+/-0,08mm) 5,4mm
 Panel Thickness Hole 2 1,5 ~ 1,65mm

Dimension (mm)

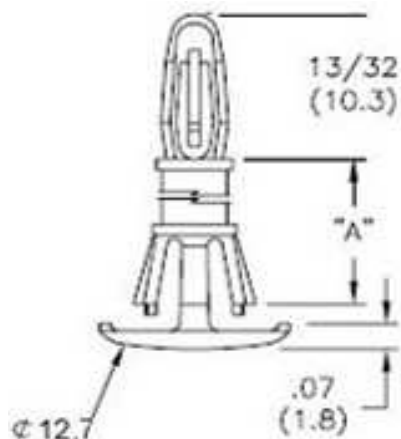

Ordering Code table

Order Code	A			
A01	6,4			
A02	9,5			
A03	12,7			
A04	15,9			
A05				
A06				
A07				
A08				
A09				
A10				
A11				
A12				
A13				
A14				
A15				
A16				
A17				
A18				
A19				
A20				
A21				
A22				
A23				
A24				
A25				
A26				
A27				

Reverse Arrow Locking Board Spacer

Part No.: **N17102**

Customer:

DRW:	Jason	CHKD	Wilson	MATL:	Wilson	TOLERANCE	Mason	DATE	08.02.2013
APPD:	Schumi			FINISH	Jamy		Sheet No.		1 from 2

EDCON-COMPONENTS



Ordering Informations

Serie	Order Code table	Material	Color	ROHS	Packing					
N17102	A01	NY	WH	R	BU					

A01= Length	NY= Nylon	WH= White	R= ROHS Conform	BU= Bulk-Ware			
			N= NON ROHS Conform	IV= Individual Packing			

Reverse Arrow Locking Board Spacer	
Part No.:	N17102
Customer:	

DRW:	Jason	CHKD	Wilson	MATL:	Wilson	TOLERANCE	Mason	DATE	08.02.2013
APPD:	Schumi			FINISH	Jamy			Sheet No.	2 from 2