

EDCON-COMPONENTS

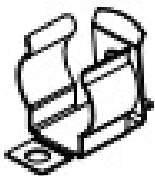

Drawing inch / mm

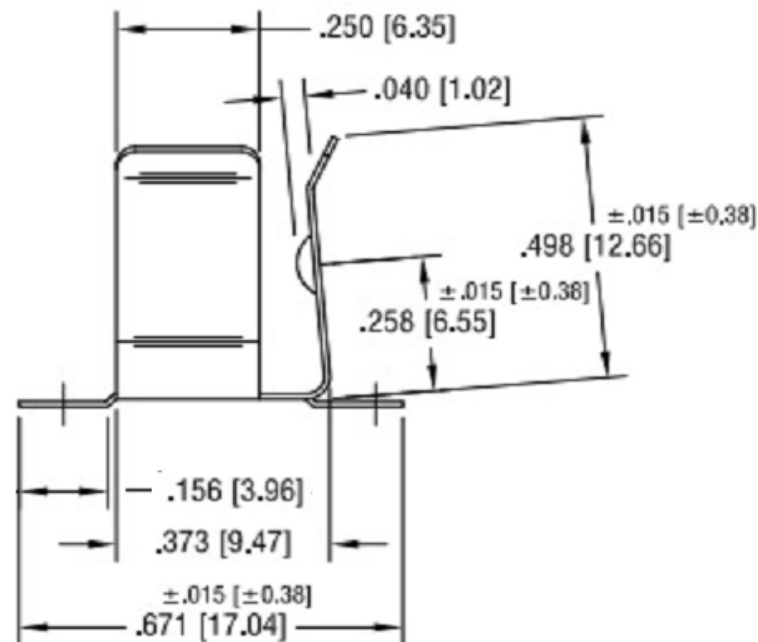
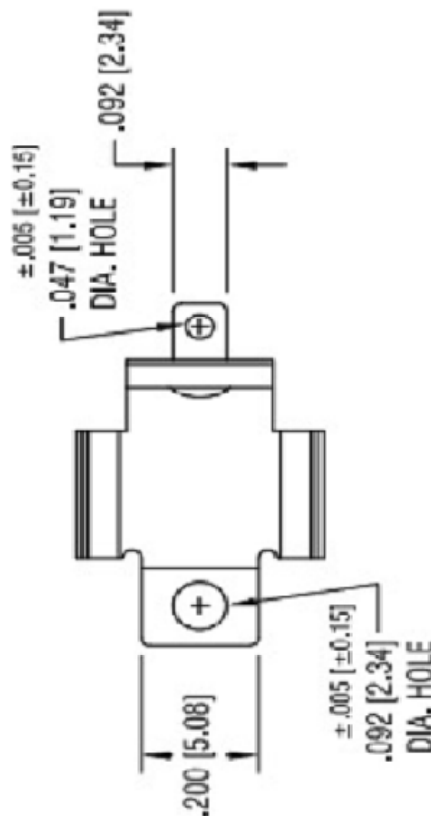
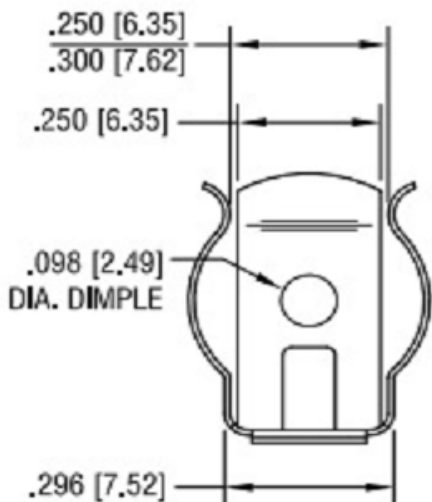

AAA / N PC-Batterie CLIP

Material: Annealed Spring Steel
Surface: Tin Nickel Plate

Tolerances

Inch .+/-0,01
mm .+/-0,25
Angle .+/-2°

Unless otherwise specified

DRW:	Jason	CHKD	Wilson	MATL:	Wilson	TOLERANCE	Mason	DATE	01.10.2019
APPD:	Schumi			FINISH	Jamy		Sheet No.	1 from 3	

SMD-PCB AAA / N Batterie-Clip	
Part No.:	B38003
Customer:	

www.edcon-components.com

email: info@edcon-components.com

EDCON-COMPONENTS

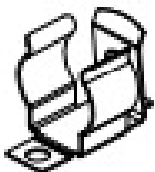

Ordering Informations

PCB Layout inch/mm AAA / N Battery-Type

Serie	Special function	Special Code	ROHS	Packing	
-------	------------------	--------------	------	---------	--

B38003	N	N	R	BU	
---------------	----------	----------	----------	-----------	--

N = No special function	N = No special function	R = ROHS Conform	BU = Bulk-Ware

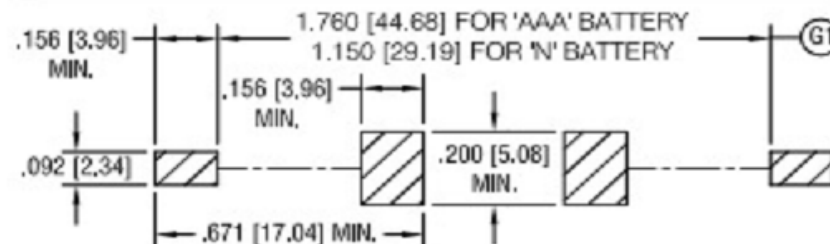

SMD-PCB AAA / N Batterie-Clip	
Part No.:	B38003
Customer:	

DRW:	Jason	CHKD	Wilson	MATL:	Wilson	TOLERANCE	Mason	DATE	01.10.2019
APPD:	Schumi			FINISH	Jamy		Sheet No.	2 from 3	

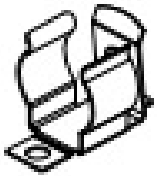

Soldering Profile Curve

Classification Reflow Profile (JEDEC J-STD-020C)

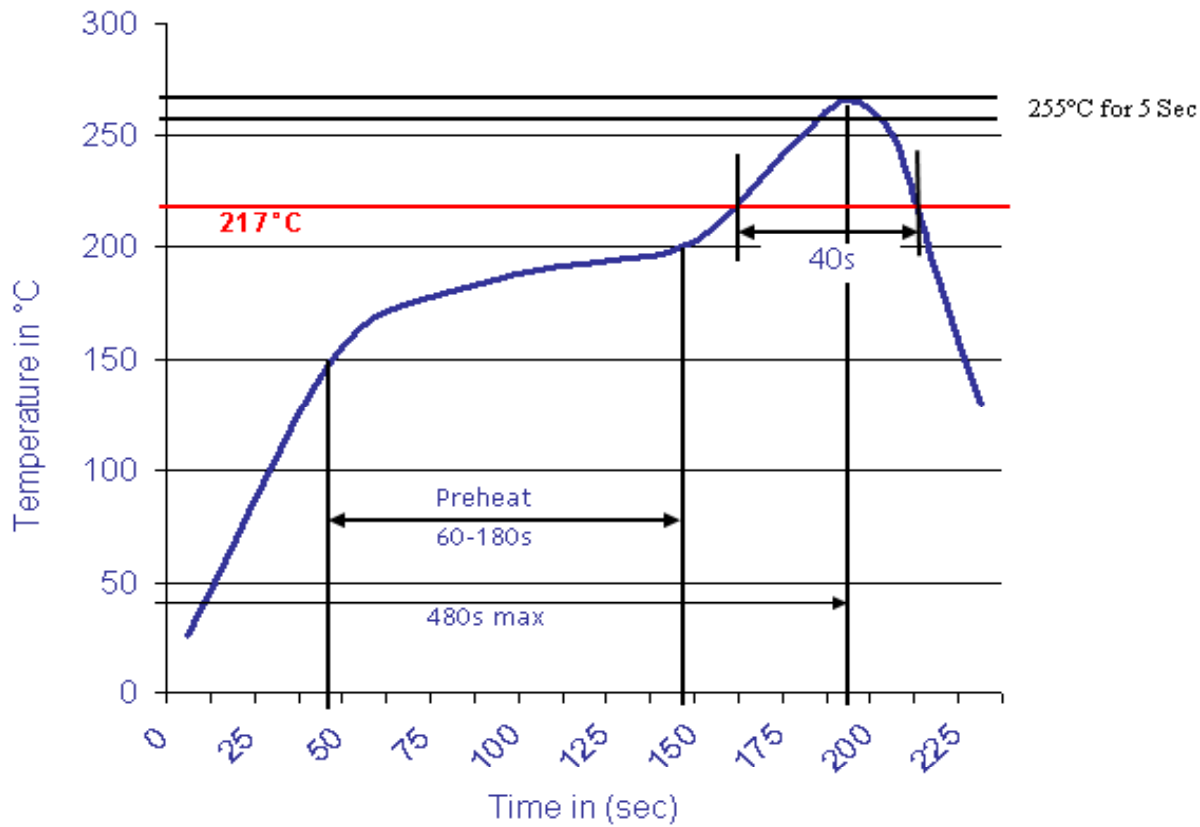

SMD-PCB AAA / N Batterie-Clip	
Part No.:	B38003
Customer:	

DRW:	Jason	CHKD	Wilson	MATL:	Wilson	TOLERANCE	Mason	DATE	01.10.2019
APPD:	Schumi			FINISH	Jamy		Sheet No.	3 from 3	