

# EDCON-COMPONENTS

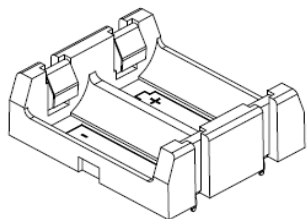

## Technical Specification

Body Material: PBT 15% Glass Filled  
 Contact Material: Stainless Steel  
 Contact Plating: Tin Nickel Plate

## Technical Drawing

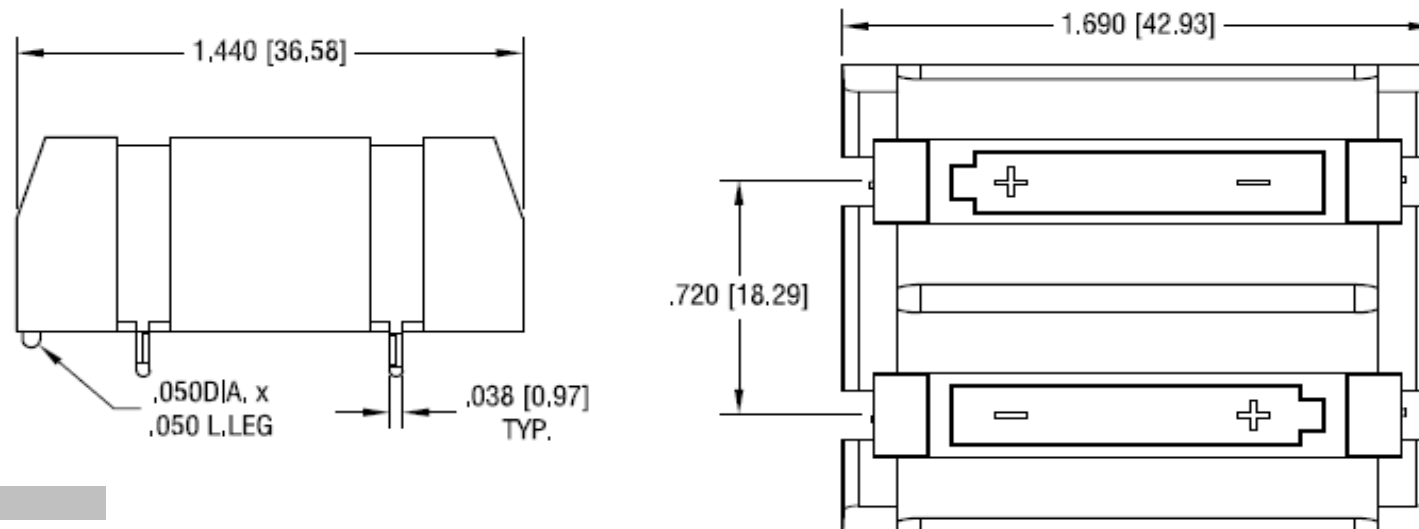

## PCB Layout (inch / mm)

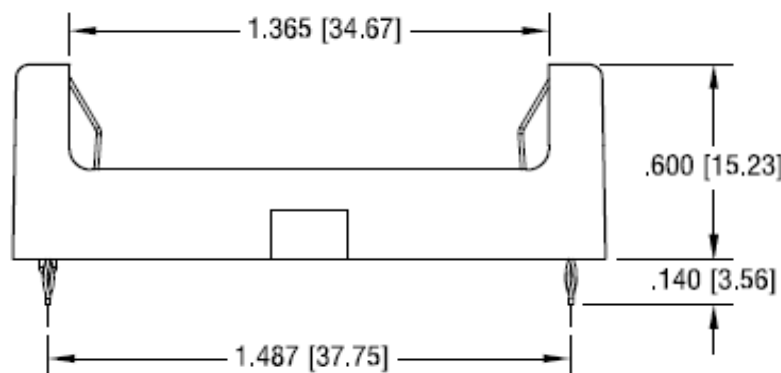
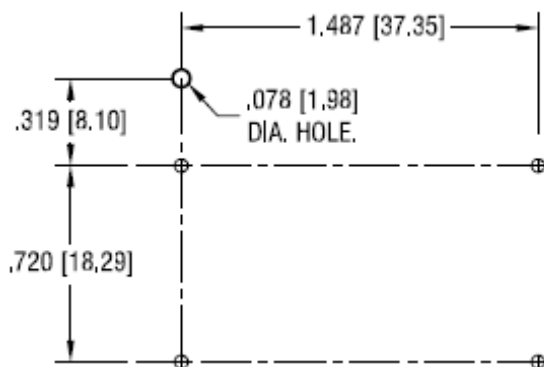

<b>THT Batteriehalter 2/3A</b>	
Part No.:	<b>B30018</b>
Customer:	

DRW:	Jason	CHKD	Wilson	MATL:	Wilson	TOLERANCE	Mason	DATE	04.11.2018
APPD:	Schumi			FINISH	Jamy		Sheet No.		1 from 3

# EDCON-COMPONENTS

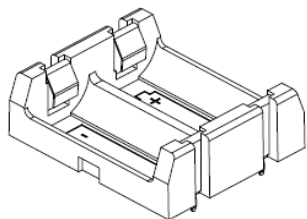

## Ordering Informations

Serie	Contact Plating	Spezial Function	Spezial Function	Spezial Function	ROHS	Packing				
-------	-----------------	------------------	------------------	------------------	------	---------	--	--	--	--

<b>B30018</b>	<b>TN</b>	<b>0</b>	<b>0</b>	<b>0</b>	<b>R</b>	<b>TR</b>				
---------------	-----------	----------	----------	----------	----------	-----------	--	--	--	--

	<b>0=</b> No function	<b>0=</b> No function	<b>0=</b> No function	<b>R=</b> ROHS Conform	<b>B101=</b> Bulk-Ware 100PCS
<b>TN=</b> Tin-Nickel Plated					<b>TR=</b> Tape Reel

**THT Batteriehalter 2/3A**

Part No.: **B30018**

Customer:

DRW:	Jason	CHKD	Wilson	MATL:	Wilson	TOLERANCE	Mason	DATE	04.11.2018
APPD:	Schumi			FINISH	Jamy		Sheet No.		2 from 3

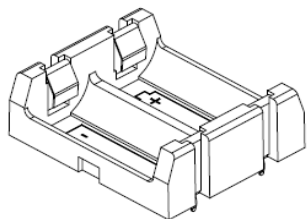

Soldering Profile Curve

Classification Reflow Profile (JEDEC J-STD-020C)

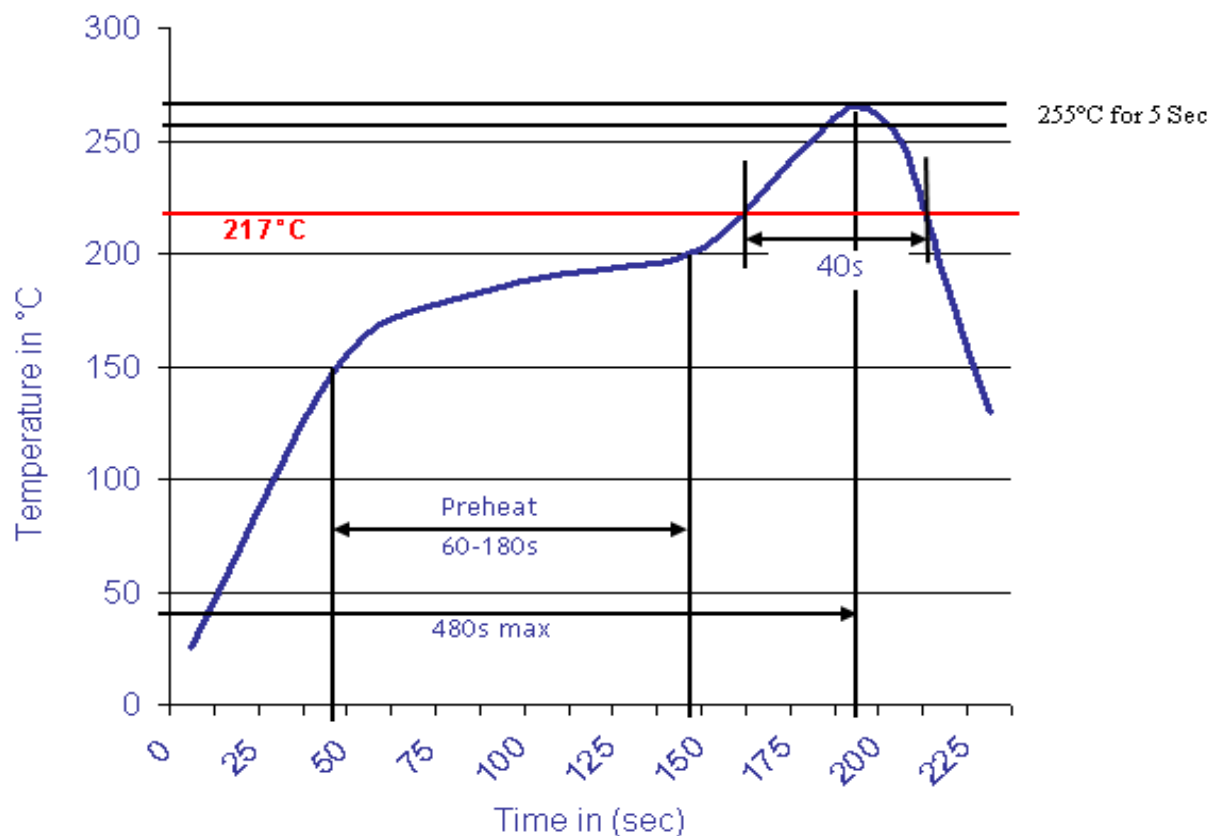

THT Batteriehalter 2/3A

Part No.: **B30018**

Customer:

DRW:	Jason	CHKD	Wilson	MATL:	Wilson	TOLERANCE	Mason	DATE	04.11.2018
APPD:	Schumi			FINISH	Jamy		Sheet No.	3 from 3	