

EDCON-COMPONENTS

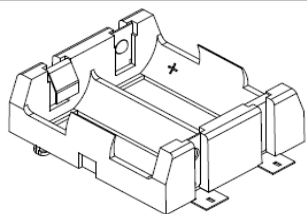

Technical Specification

Body Material: Nylon 46 or Equivalent
 Contact Material: Stainless Steel
 Contact Plating: Gold Flash over Nickel

Technical Drawing

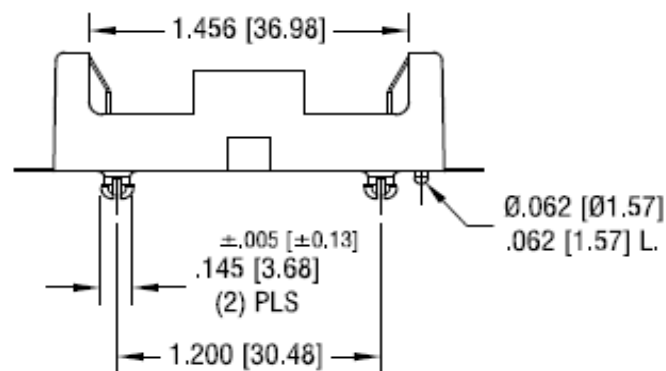
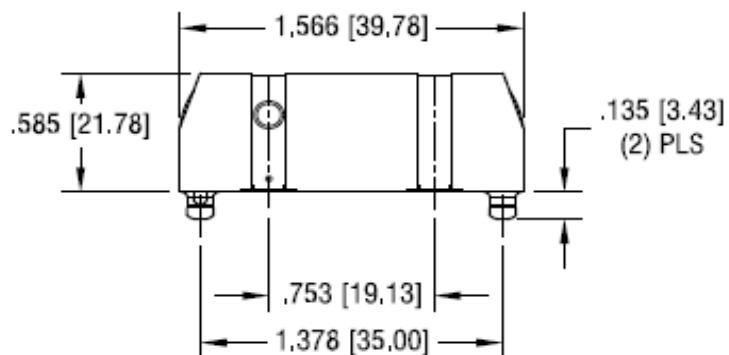

PCB Layout (inch / mm)

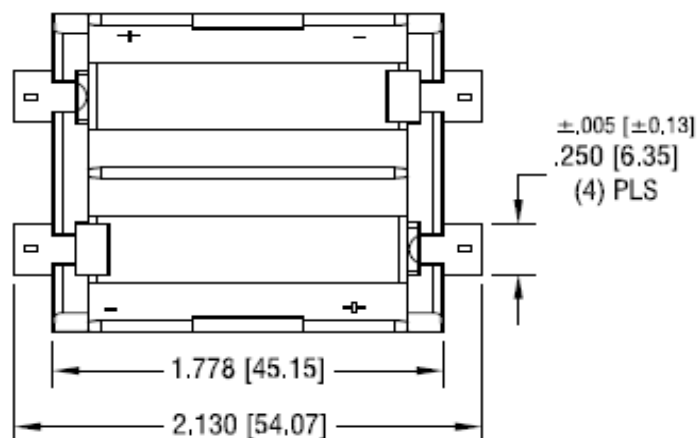
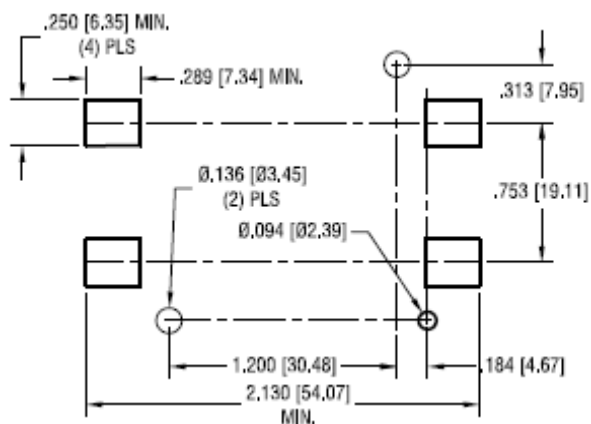

| | |
|--|---------------|
| SMD Batteriehalter 18350 2 Cell | |
| Part No.: | B30014 |
| Customer: | |

| | | | | | | | | | |
|-------|--------|---------|--------|-------|--------|------------|-------|-------|------------|
| DRW: | Jason | CHKD: | Wilson | MATL: | Wilson | TOLERANCE: | Mason | DATE: | 04.11.2018 |
| APPD: | Schumi | FINISH: | Jamy | | | Sheet No.: | | | 1 from 3 |

EDCON-COMPONENTS

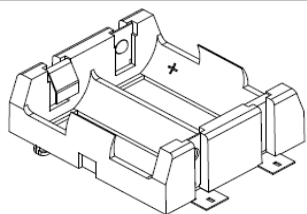

Ordering Informations

| Serie | Contact Plating | Spezial Function | Spezial Function | Spezial Function | ROHS | Packing | | | | |
|---------------|-----------------|------------------|------------------|------------------|----------|-----------|--|--|--|--|
| B30014 | G0 | 0 | 0 | 0 | R | TR | | | | |

| | | | | | |
|-----------------------|-----------------------|-----------------------|-----------------------|------------------------|-------------------------------|
| G0= Gold Flash | 0= No function | 0= No function | 0= No function | R= ROHS Conform | B101= Bulk-Ware 100PCS |
| | | | | | TR= Tape Reel |

| |
|--|
| SMD Batteriehalter 18350 2 Cell |
| Part No.: B30014 |
| Customer: |

| | | | | | | | | | |
|-------|--------|------|--------|--------|--------|-----------|-----------|------|------------|
| DRW: | Jason | CHKD | Wilson | MATL: | Wilson | TOLERANCE | Mason | DATE | 04.11.2018 |
| APPD: | Schumi | | | FINISH | Jamy | | Sheet No. | | 2 from 3 |

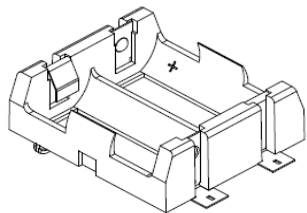

Soldering Profile Curve

Classification Reflow Profile (JEDEC J-STD-020C)

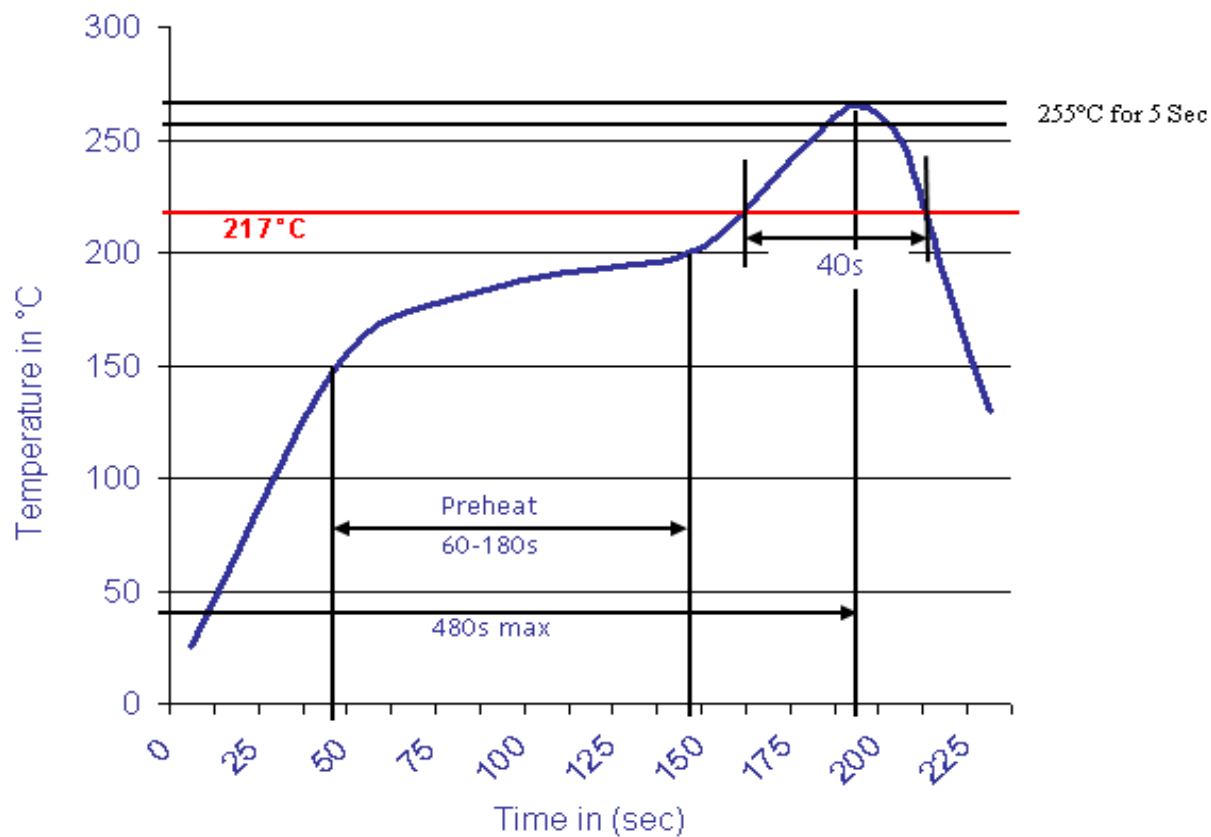

| | |
|--|---------------|
| SMD Batteriehalter 18350 2 Cell | |
| Part No.: | B30014 |
| Customer: | |

| | | | | | | | | | |
|-------|--------|-------|--------|---------|--------|------------|-----------|-------|------------|
| DRW: | Jason | CHKD: | Wilson | MATL: | Wilson | TOLERANCE: | Mason | DATE: | 04.11.2018 |
| APPD: | Schumi | | | FINISH: | Jamy | | Sheet No. | | 3 from 3 |