

EDCON-COMPONENTS

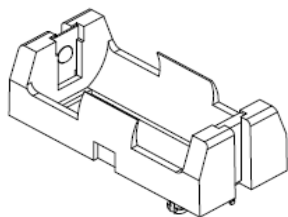

Technical Specification

Body Material: Nylon 46 or Equivalent
 Contact Material: Stainless Steel
 Contact Plating: Gold Flash over Nickel

Technical Drawing

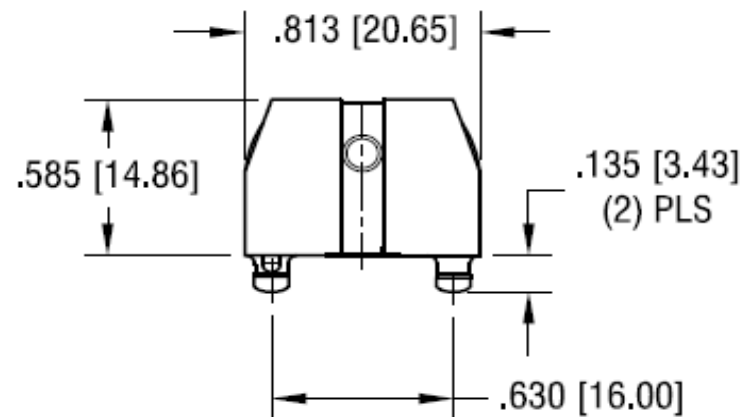
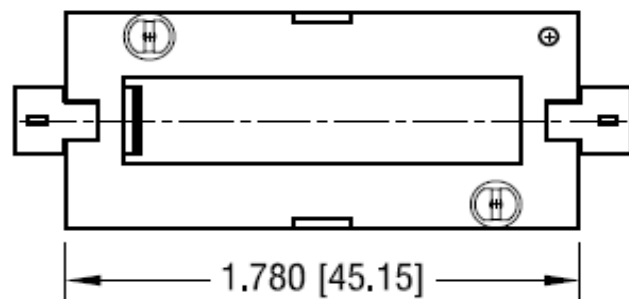

PCB Layout (inch / mm)

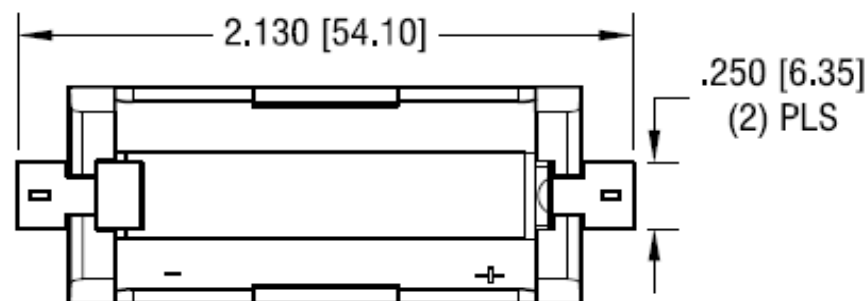
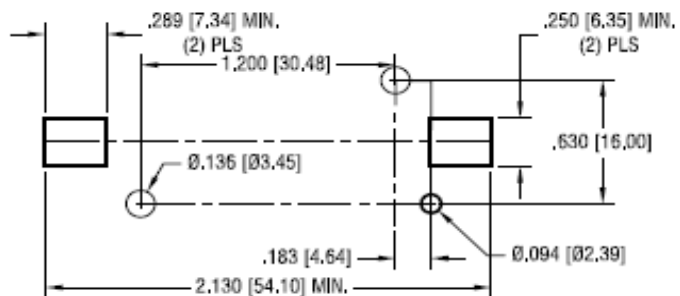

SMD Batteriehälter 18350 1 Cell	
Part No.:	B30013
Customer:	

DRW:	Jason	CHKD:	Wilson	MATL:	Wilson	TOLERANCE:	Mason	DATE:	04.11.2018
APPD:	Schumi	FINISH:	Jamy				Sheet No.		1 from 3

EDCON-COMPONENTS

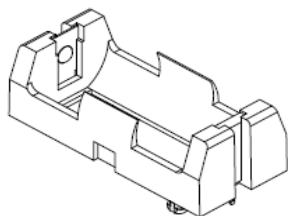

Ordering Informations

Serie	Contact Plating	Spezial Function	Spezial Function	Spezial Function	ROHS	Packing				
B30013	G0	0	0	0	R	TR				

G0 = Gold Flash	0 = No function	0 = No function	0 = No function	R = ROHS Conform	B101 = Bulk-Ware 100PCS
					TR = Tape Reel

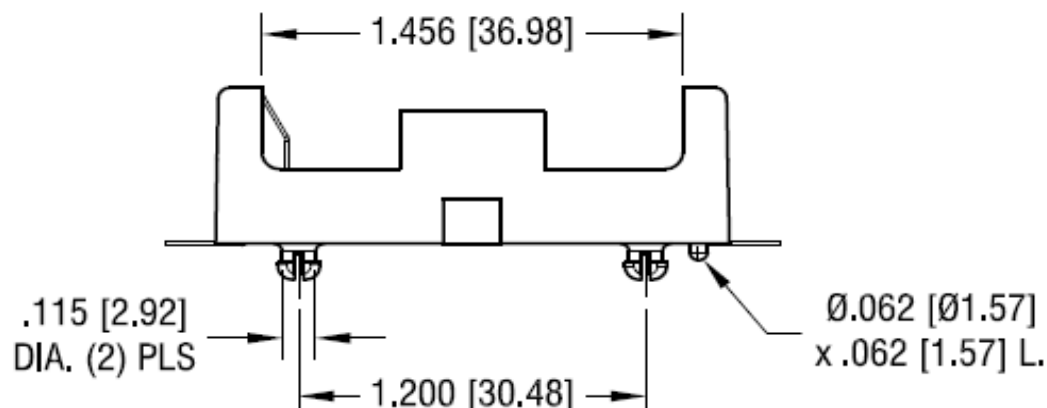

SMD Batteriehalter 18350 1 Cell
Part No.: B30013
Customer:

DRW:	Jason	CHKD	Wilson	MATL:	Wilson	TOLERANCE	Mason	DATE	04.11.2018
APPD:	Schumi			FINISH	Jamy		Sheet No.		2 from 3

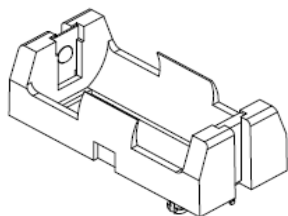

Soldering Profile Curve

Classification Reflow Profile (JEDEC J-STD-020C)

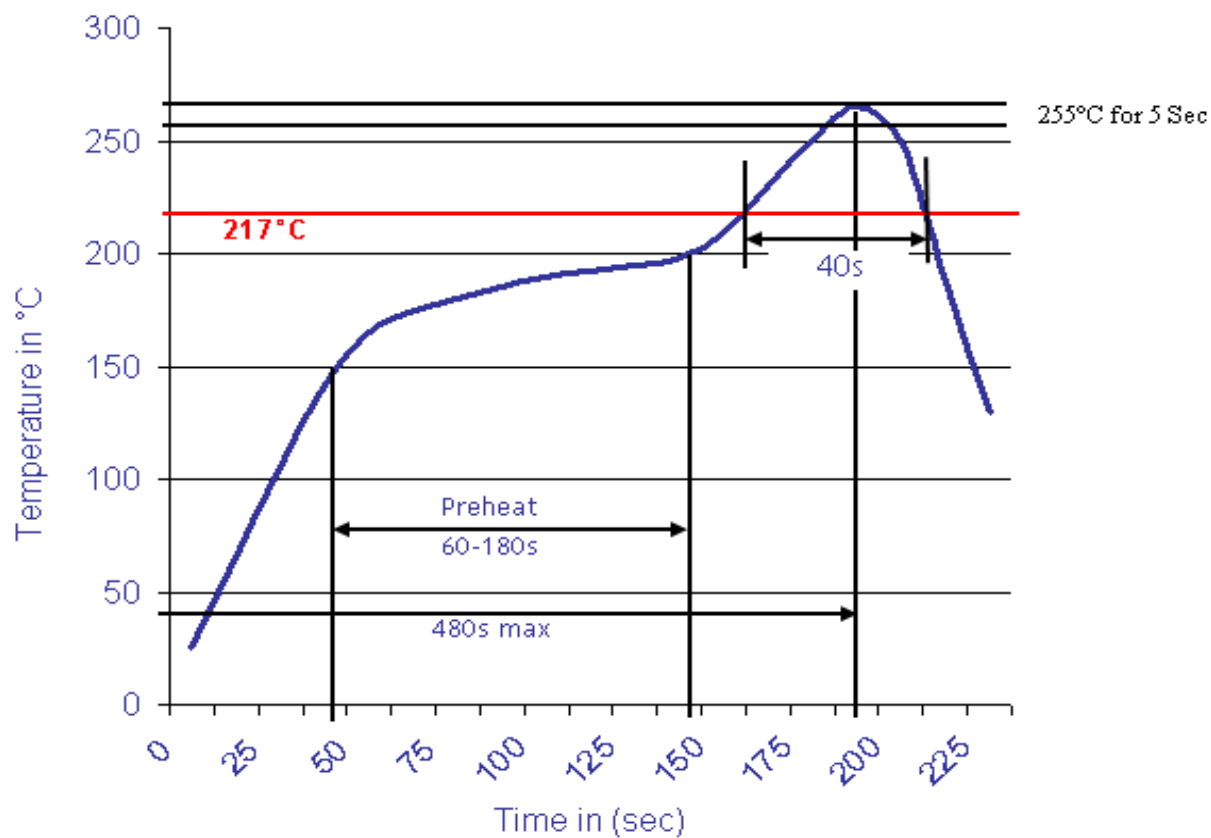

SMD Batteriehalter 18350 1 Cell	
Part No.:	B30013
Customer:	

DRW:	Jason	CHKD	Wilson	MATL:	Wilson	TOLERANCE	Mason	DATE	04.11.2018
APPD:	Schumi			FINISH	Jamy		Sheet No.	3 from 3	