

EDCON-COMPONENTS

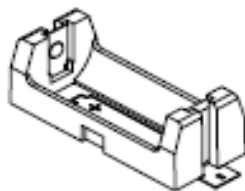

Technical Specification

Body Material: Nylon 46 or Equivalent
 Contact Material: Stainless Steel
 Contact Plating: Gold Flash over Nickel

Technical Drawing

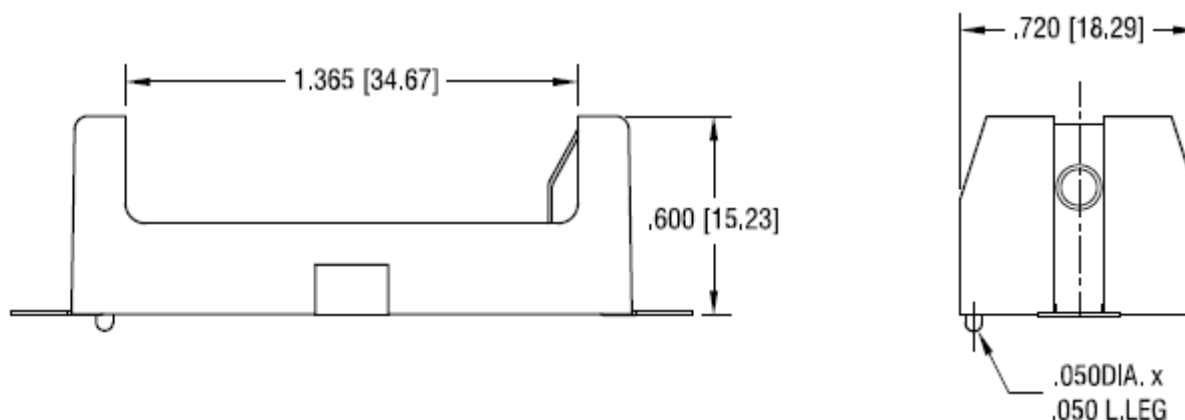

PCB Layout (inch / mm)

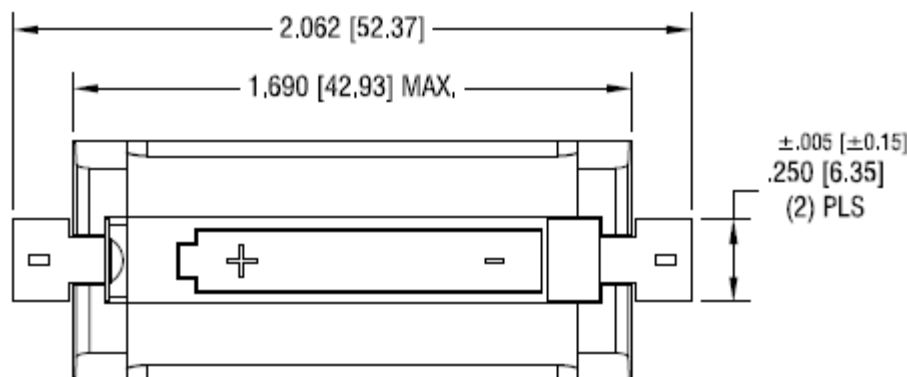
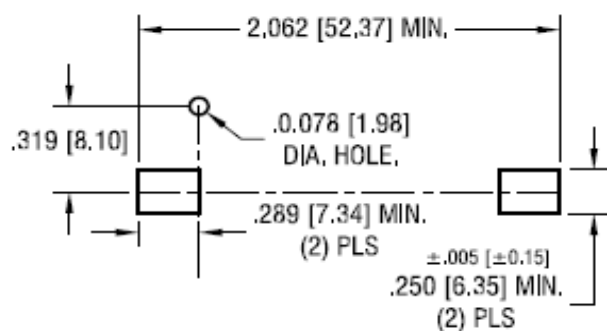

**SMD Batteriehalter CR123A
1 Cell**

Part No.: **B30010**

DRW:	Jason	CHKD	Wilson	MATL:	Wilson	TOLERANCE	Mason	DATE	04.11.2018
APPD:	Schumi			FINISH	Jamy		Sheet No.		1 from 3

Customer:

EDCON-COMPONENTS

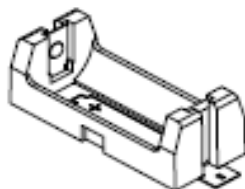

Ordering Informations

Serie	Contact Plating	Spezial Function	Spezial Function	Spezial Function	ROHS	Packing				
B30010	G0	0	0	0	R	TR				

G0= Gold Flash	0= No function	0= No function	0= No function	R= ROHS Conform	B101= Bulk-Ware 100PCS
					TR= Tape Reel

SMD Batteriehalter CR123A 1 Cell
Part No.: B30010
Customer:

DRW:	Jason	CHKD	Wilson	MATL:	Wilson	TOLERANCE	Mason	DATE	04.11.2018
APPD:	Schumi			FINISH	Jamy		Sheet No.		2 from 3

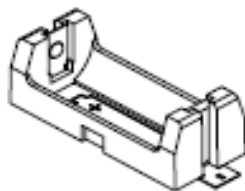

Soldering Profile Curve

Classification Reflow Profile (JEDEC J-STD-020C)

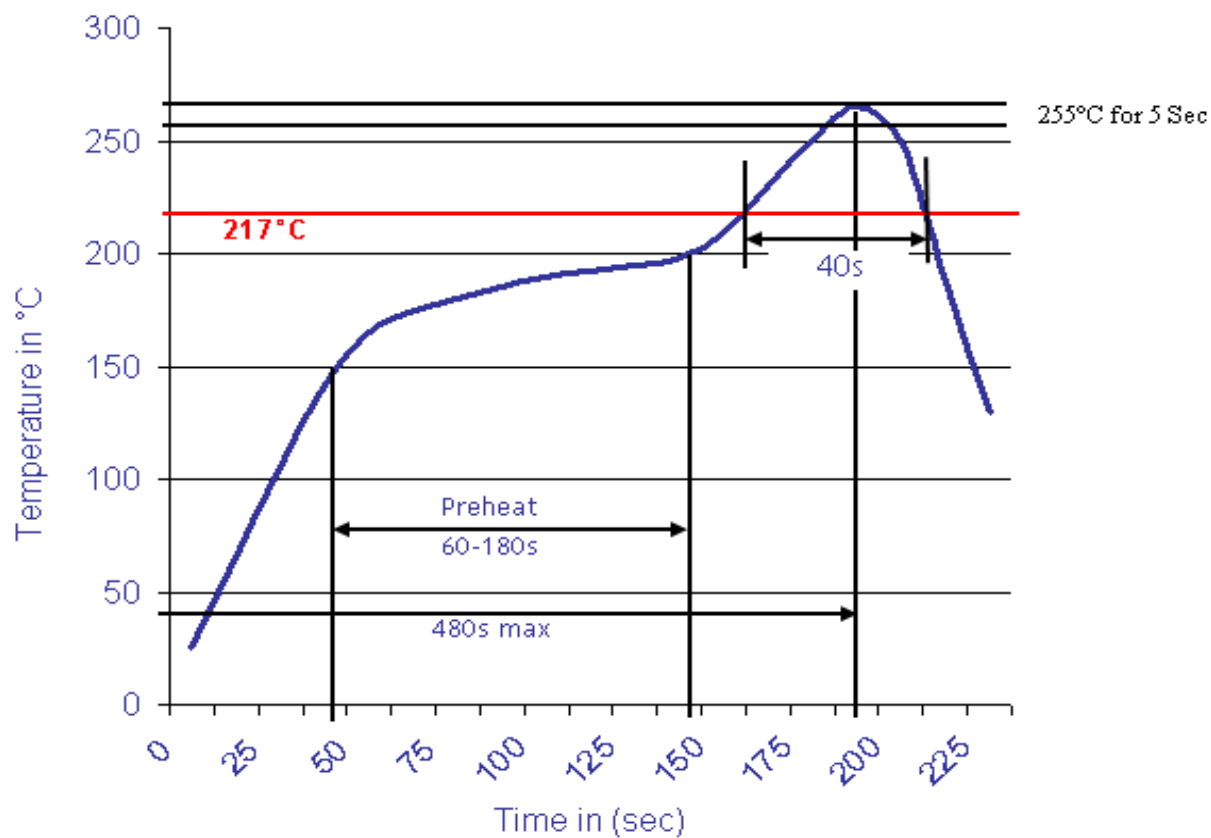

SMD Batteriehalter CR123A	
1 Cell	
Part No.:	B30010
Customer:	

DRW:	Jason	CHKD	Wilson	MATL:	Wilson	TOLERANCE	Mason	DATE	04.11.2018
APPD:	Schumi			FINISH	Jamy		Sheet No.	3 from 3	