

# EDCON-COMPONENTS

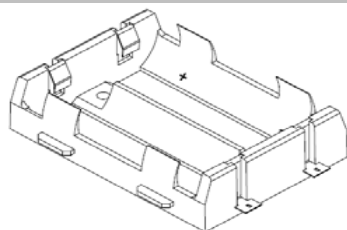

## Technical Specification

Body Material: Nylon 46 or Equivalent  
 Contact Material: Stainless Steel  
 Contact Plating: Gold Flash over Nickel

## Technical Drawing

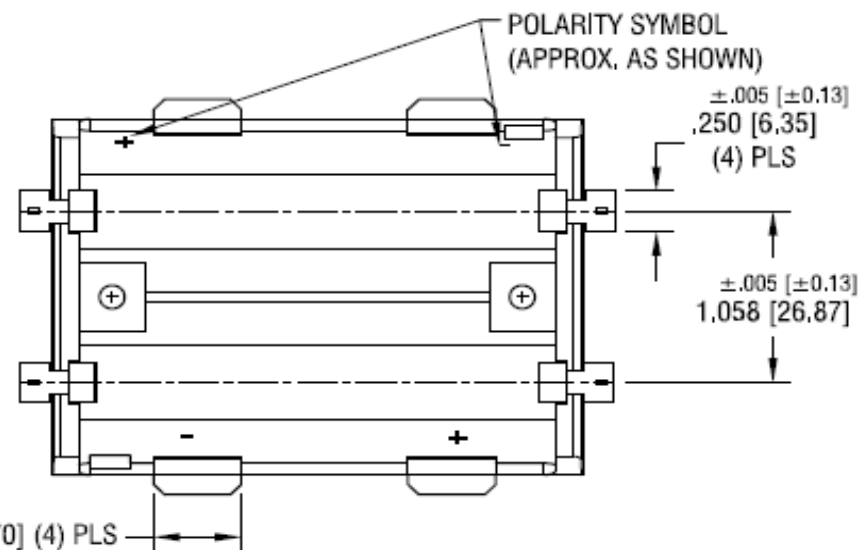
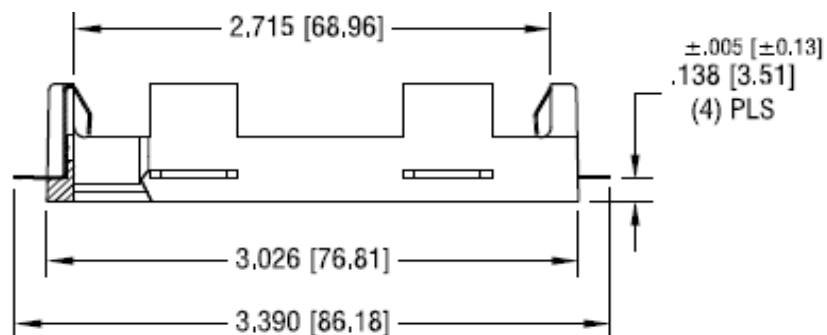

## PCB Layout (inch / mm)

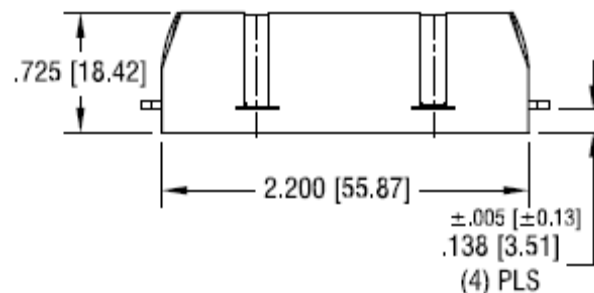
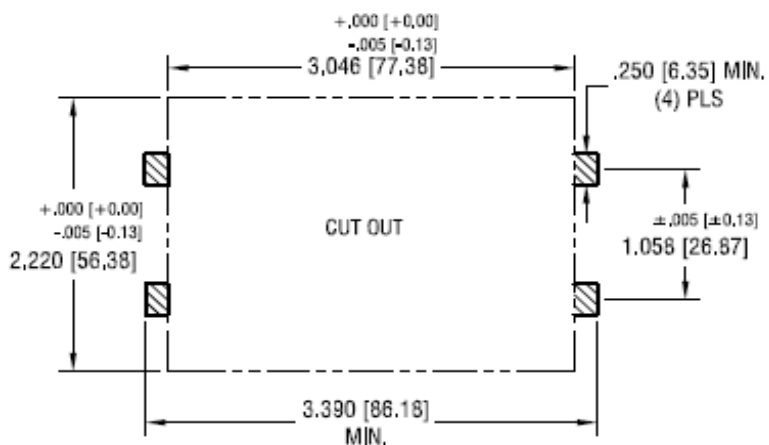

<b>SMD Batteriehalter 26650</b>	<b>2</b>
<b>Cell</b>	
Part No.:	<b>B30009</b>
Customer:	

DRW:	Jason	CHKD	Wilson	MATL:	Wilson	TOLERANCE	Mason	DATE	03.11.2018
APPD:	Schumi			FINISH	Jamy		Sheet No.		1 from 3

# EDCON-COMPONENTS

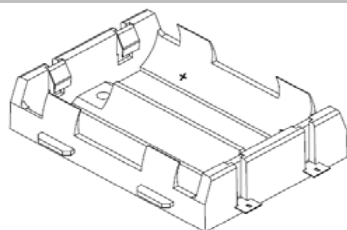

## Ordering Informations

Serie	Contact Plating	Spezial Function	Spezial Function	Spezial Function	ROHS	Packing				
<b>B30009</b>	<b>G0</b>	<b>0</b>	<b>0</b>	<b>0</b>	<b>R</b>	<b>TR</b>				

<b>G0=</b> Gold Flash	<b>0=</b> No function	<b>0=</b> No function	<b>0=</b> No function	<b>R=</b> ROHS Conform	<b>B101=</b> Bulk-Ware 100PCS
					<b>TR=</b> Tape Reel

<b>SMD Batteriehalter 26650 Cell</b>	<b>2</b>
Part No.:	<b>B30009</b>
Customer:	

DRW:	Jason	CHKD	Wilson	MATL:	Wilson	TOLERANCE	Mason	DATE	03.11.2018
APPD:	Schumi			FINISH	Jamy		Sheet No.		2 from 3

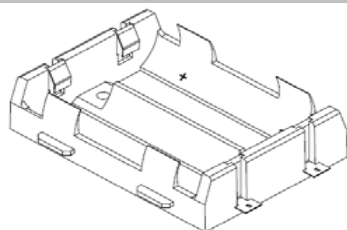

Soldering Profile Curve

Classification Reflow Profile (JEDEC J-STD-020C)

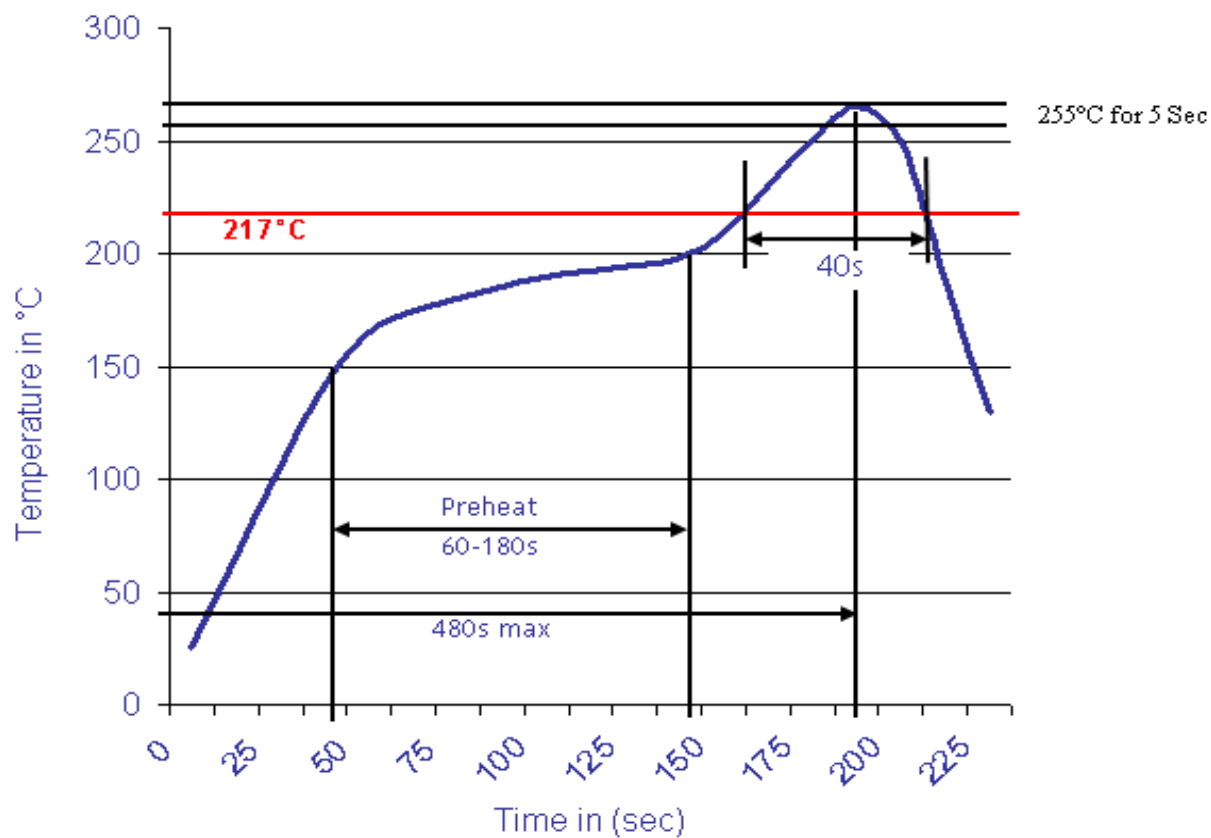

SMD Batteriehalter 26650 Cell	2
Part No.:	<b>B30009</b>
Customer:	

DRW:	Jason	CHKD	Wilson	MATL:	Wilson	TOLERANCE	Mason	DATE	03.11.2018
APPD:	Schumi			FINISH	Jamy		Sheet No.		3 from 3