

EDCON-COMPONENTS

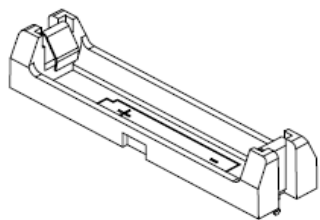

Technical Specification

Body Material: Nylon 46 or Equivalent
 Contact Material: Stainless Steel
 Contact Plating: Tin Nickel Plate

Technical Drawing

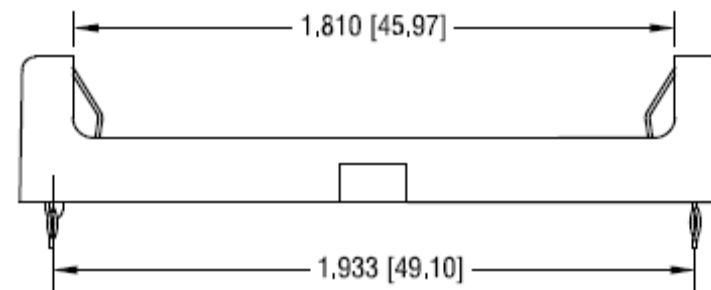
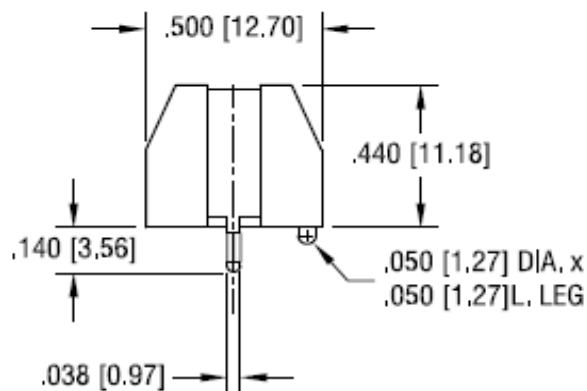

PCB Layout (inch / mm)

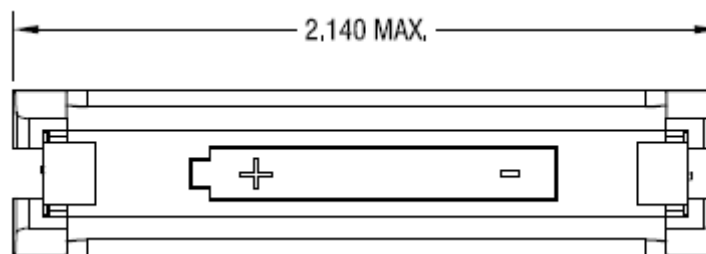
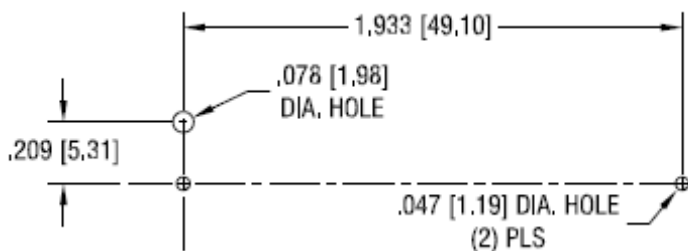

THT Batteriehalter AAA

Part No.: **B29018**

Customer:

DRW:	Jason	CHKD	Wilson	MATL:	Wilson	TOLERANCE	Mason	DATE	04.11.2018
APPD:	Schumi			FINISH	Jamy		Sheet No.		1 from 3

EDCON-COMPONENTS

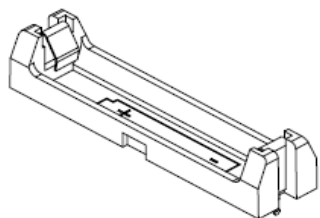

Ordering Informations

Serie	Contact Plating	Spezial Function	Spezial Function	Spezial Function	ROHS	Packing				
-------	-----------------	------------------	------------------	------------------	------	---------	--	--	--	--

B29018	TN	0	0	0	R	TR				
---------------	-----------	----------	----------	----------	----------	-----------	--	--	--	--

	0= No function	0= No function	0= No function	R= ROHS Conform	B101= Bulk-Ware 100PCS
TN= Tin-Nickel Plated					TR= Tape Reel

THT Batteriehalter AAA

Part No.: **B29018**

DRW:	Jason	CHKD	Wilson	MATL:	Wilson	TOLERANCE	Mason	DATE	04.11.2018
APPD:	Schumi			FINISH	Jamy		Sheet No.		2 from 3

Customer:

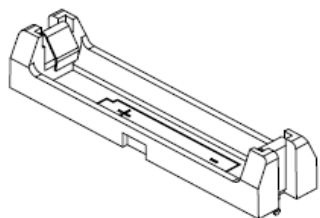

Soldering Profile Curve

Classification Reflow Profile (JEDEC J-STD-020C)

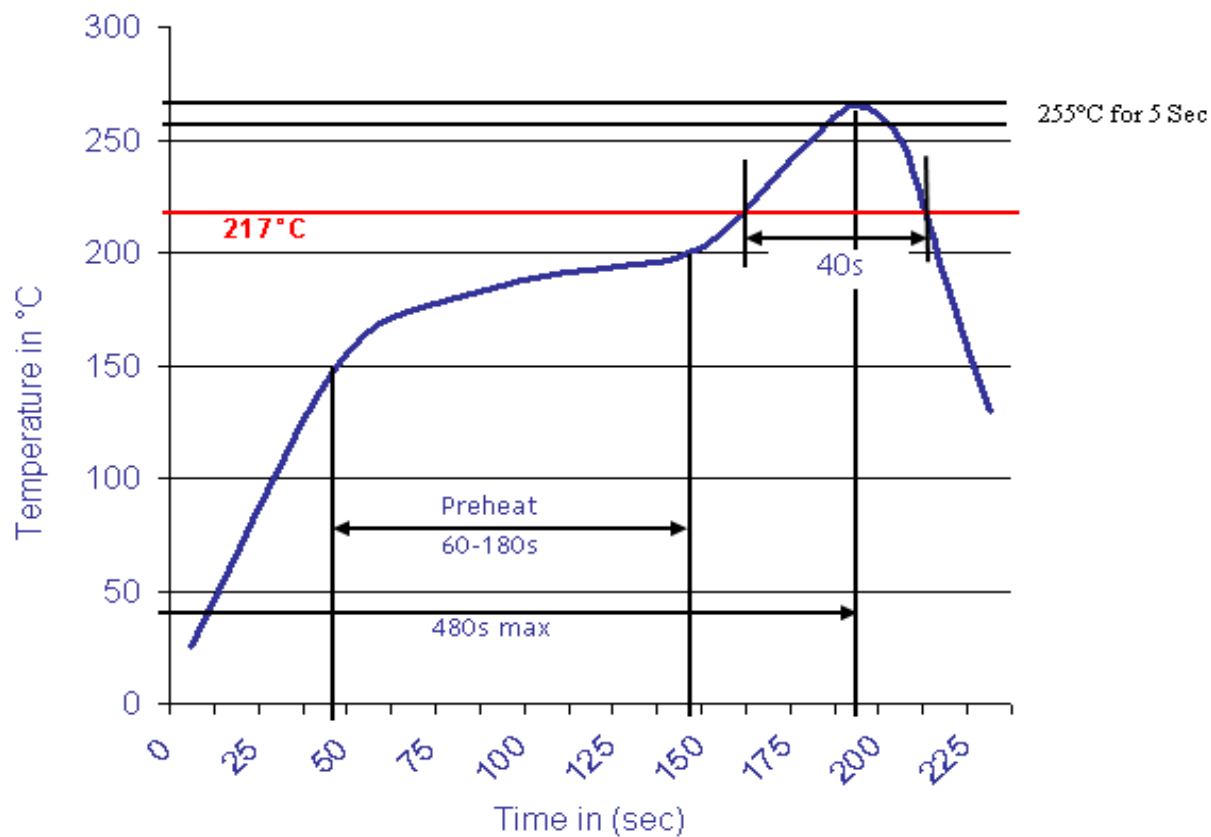

THT Batteriehalter AAA

Part No.: **B29018**

Customer:

DRW:	Jason	CHKD	Wilson	MATL:	Wilson	TOLERANCE	Mason	DATE	04.11.2018
APPD:	Schumi			FINISH	Jamy		Sheet No.		3 from 3