

Data Sheet

Pluggable Terminal Block (Wafer) LEFT

Pitch: 5,00 mm

Serie: A14L156

Customer Information for special Item

EDCON Customer : xxxxxx

Customer Version No. : xx

EDCON-COMPONENTS

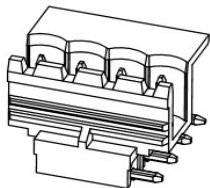

Technical Description

Electrical:

Rated voltage:

Rated current:

Withstanding Voltage: AC/1min:

Operating Temperature:

Mechanical:

Strip length: mm

Wire range: Solid wire: AWG

Wire range: Stranded wire: AWG

Material:

Housing Terminal Body:

Material Screw:

Material Terminal:

UL	IEC	VDE
300	300	
15A	15A	
1600V	1600V	

-40°C ~ +115°C

PA66 UL94V-0

Copper Matte Tin plated over Nickel

Drawing (Dimension in mm)

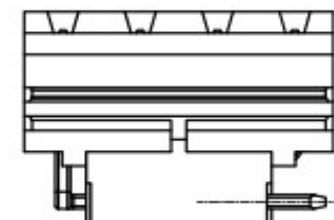
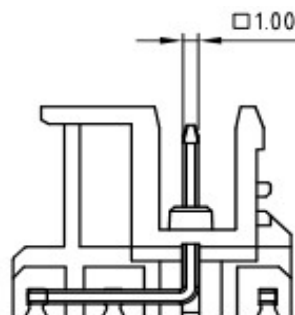
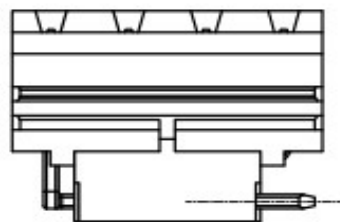
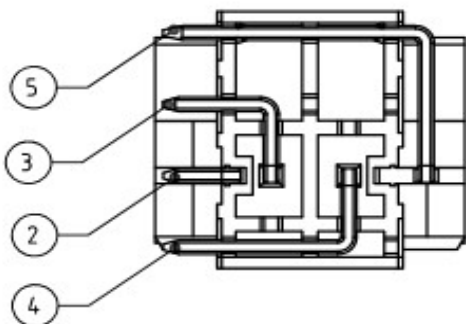
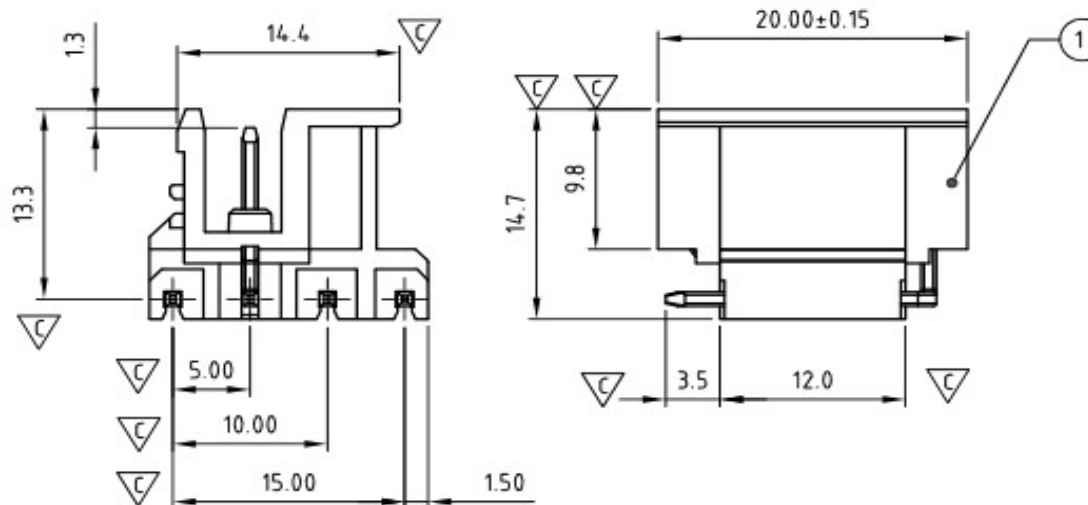

Tolerances unless otherwise specified (mm)

x	x.x	x.xx	x.xxx	Angle
±	±	±	±	±3°

**Pluggable Terminal Block
(Wafer) LEFT**

Part No.: **A14L156**

Customer:

DRW:	Jason	CHKD	Wilson	MATL:	Wilson	TOLERANCE	Mason	DATE	17.03.2024
APPD:	Schumi			FINISH	Jamy			Sheet No.	1 from 4

www.edcon-components.com

email: info@edcon-components.com

EDCON-COMPONENTS

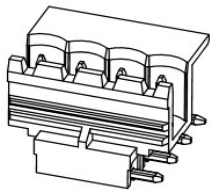

PCB Layout

Dimensions / Tolerance (mm)

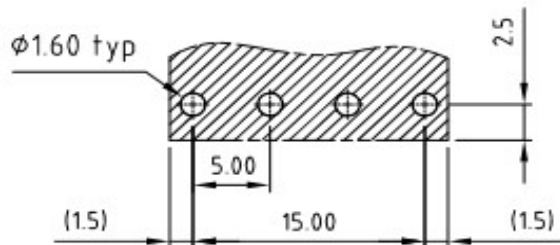

**Pluggable Terminal Block
(Wafer) LEFT**

Part No.: **A14L156**

DRW:	Jason	CHKD	Wilson	MATL:	Wilson	TOLERANCE	Mason	DATE	17.03.2024
APPD:	Schumi			FINISH	Jamy		Sheet No.		2 from 4

Customer:

www.edcon-components.com

email: info@edcon-components.com

EDCON-COMPONENTS

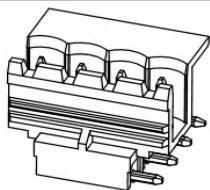

Ordering Informations

Serie	No. of Pos.	Body Color	No Function	Approval Code	ROHS	Packing	EDCON Cust. No.	Customer Version		
A14L156	04	PG	N	N	R	B	xxxxxx	xx		

Pitch
5,00

04= Number of Pos.	PG= Phoenix Green (Standard) WH= White GN= Green BL= Blue BK= Black YE= Yellow RD= Red	N= No function	N= NON Approval 1= UL-Approval for Material A= UL /UR Approval Please consult EDCON for available B= VDE Approval Please consult EDCON for available C= TÜV Approval Please consult EDCON for available	R= ROHS Conform N= NON ROHS Conform	B= Bulk-Ware I= Individual Package	xxxxxx= Customer Number	xx= Customer Version ??(Printing)
---------------------------	---	-----------------------	--	--	---	--------------------------------	---

Pluggable Terminal Block (Wafer) LEFT
Part No.: A14L156
Customer:

DRW:	Jason	CHKD	Wilson	MATL:	Wilson	TOLERANCE	Mason	DATE	17.03.2024
APPD:	Schumi			FINISH	Jamy		Sheet No.		3 from 4

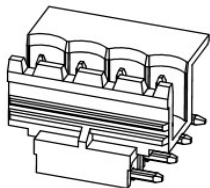

Soldering Profile Curve

Classification Reflow Profile (JEDEC J-STD-020C)

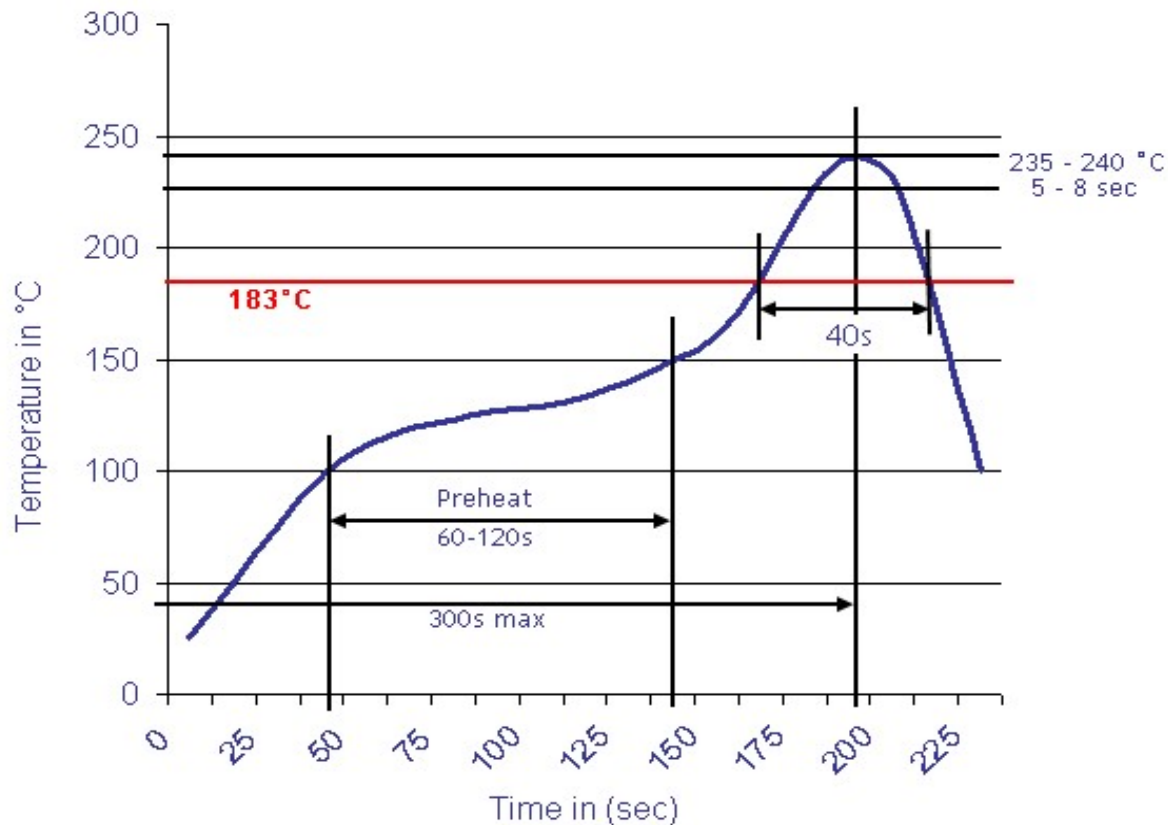

**Pluggable Terminal Block
(Wafer) LEFT**

Part No.: **A14L156**

Customer:

DRW:	Jason	CHKD	Wilson	MATL:	Wilson	TOLERANCE	Mason	DATE	17.03.2024
APPD:	Schumi			FINISH	Jamy		Sheet No.		4 from 4