

Data Sheet

Pin Header for Pluggable Terminal Block 1,3/1,3mm

Pitch: 5,00 mm

Serie: A14L136

Customer Information for special Item

EDCON Customer : Axx

Customer Version No. : 0

EDCON-COMPONENTS

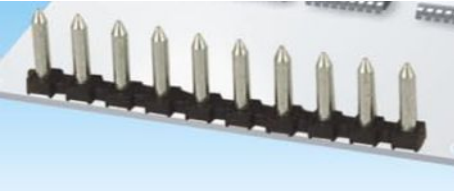

Technical Discription

Electrical:			
Rated voltage:	300V		
Rated current:	10A		
Withstanding Voltage: AC/1min:	2000V		
Operating Temperature:	-40°C ~ +105°C		
Insulation Resistance:	5000M Ω / DC1000V		
Contact Resistance:	20mΩ		

Mechanical:			

Material:			
Housing Terminal Body:	PA66 + 10%GF, UL94V-0		
Pin Material Terminal:	Brass Tin plated		

Pin Header (Dimension in mm)

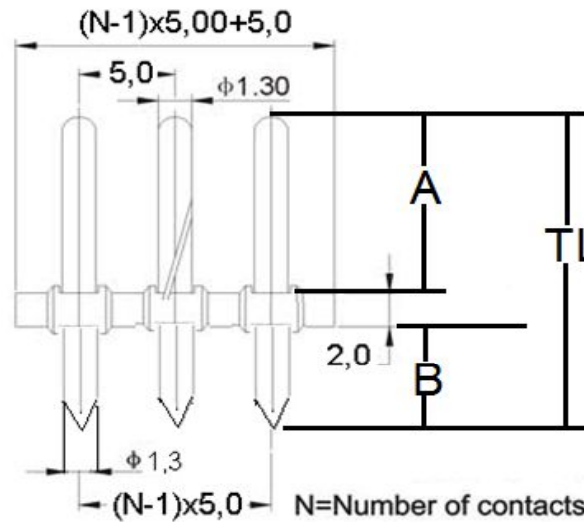

Order Code	Dimension (mm)		
	A	B	TL
A01	6,8	1,6	10,4
A02	6,8	3,8	12,6
A03	7,5	3,5	13,0
A04			
A05			
A06			
A07			
A08			
A09			
A10			

PCB Layout (mm)

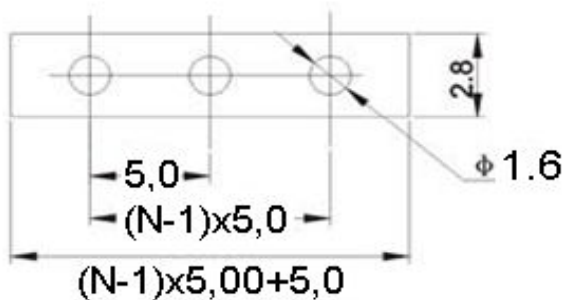

Pin length A + B look Dimension Table

Tolerances unless otherwise specified (mm)									
x	x.x	x.xx	x.xxx	Angle					
±	±	±	±	±3°					
DRW:	Jason	CHKD	Wilson	MATL:	Wilson	TOLERANCE	Mason	DATE	06.02.2023
APPD:	Schumi		FINISH	Jamy		Sheet No.		1 from 4	

Pin Header for Pluggable Terminal Block 1,3/1,3mm	
Part No.:	A14L136
Customer:	

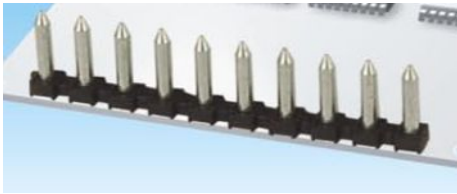

Special Version

Drawing (Dimension in mm)



7Pin Header / 4Pin Connected
Special Order Code : A01



9Pin Header / 5Pin Connected
Special Order Code : A02

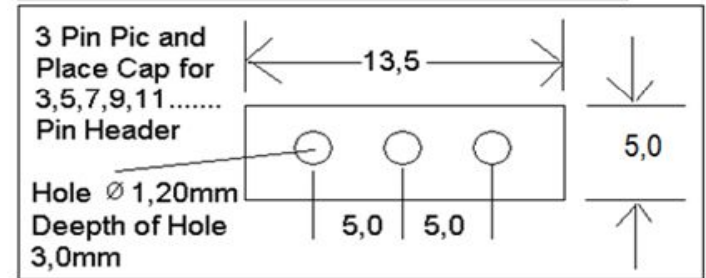
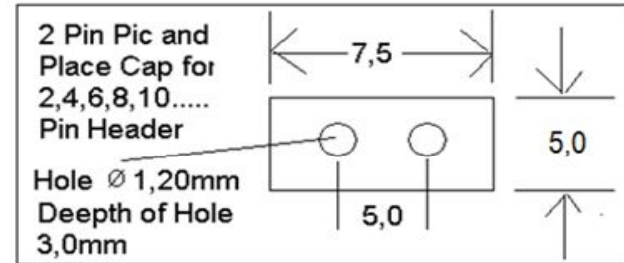
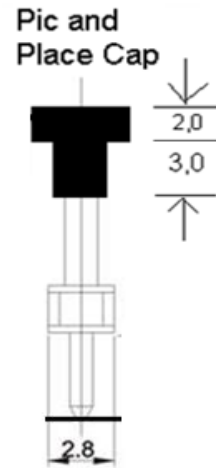

Pin Header for Pluggable Terminal Block 1,3/1,3mm
Part No.: A14L136
Customer:

DRW:	Jason	CHKD	Wilson	MATL:	Wilson	TOLERANCE	Mason	DATE	06.02.2023
APPD:	Schumi			FINISH	Jamy		Sheet No.		2 from 4

EDCON-COMPONENTS

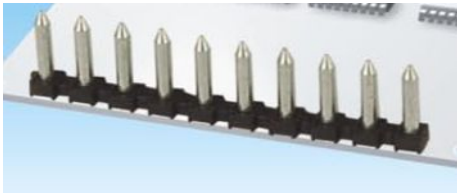

Ordering Informations

Serie	No. of Pos.	Pin Length order Code	Body Color	Approval Code	ROHS	Packing	Special Order Code			
A14L136	XX	Axx	BK	N	R	xx	Axx			

Pitch
5,00

XX= Number of Pos. 2~24	Axx= look Pin Length order code table	BK= Black	N= NON Approval	R= ROHS Conform	BU= Bulk-Ware	Axx= Special Version look Picture
		GY= Gray		N= NON ROHS Conform		
				TR= Tape Reel Packing with PIC and Place Cap		
					TC= TUBE Packing with PIC and Place Cap	

Pin Header for Pluggable Terminal Block 1,3/1,3mm	
Part No.:	A14L136
Customer:	

DRW:	Jason	CHKD	Wilson	MATL:	Wilson	TOLERANCE	Mason	DATE	06.02.2023
APPD:	Schumi			FINISH	Jamy		Sheet No.		3 from 4

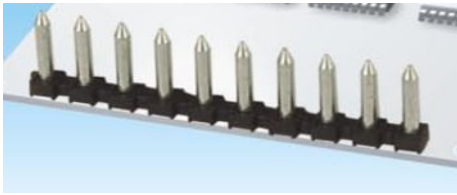

Soldering Profile Curve

Classification Reflow Profile (JEDEC J-STD-020C)

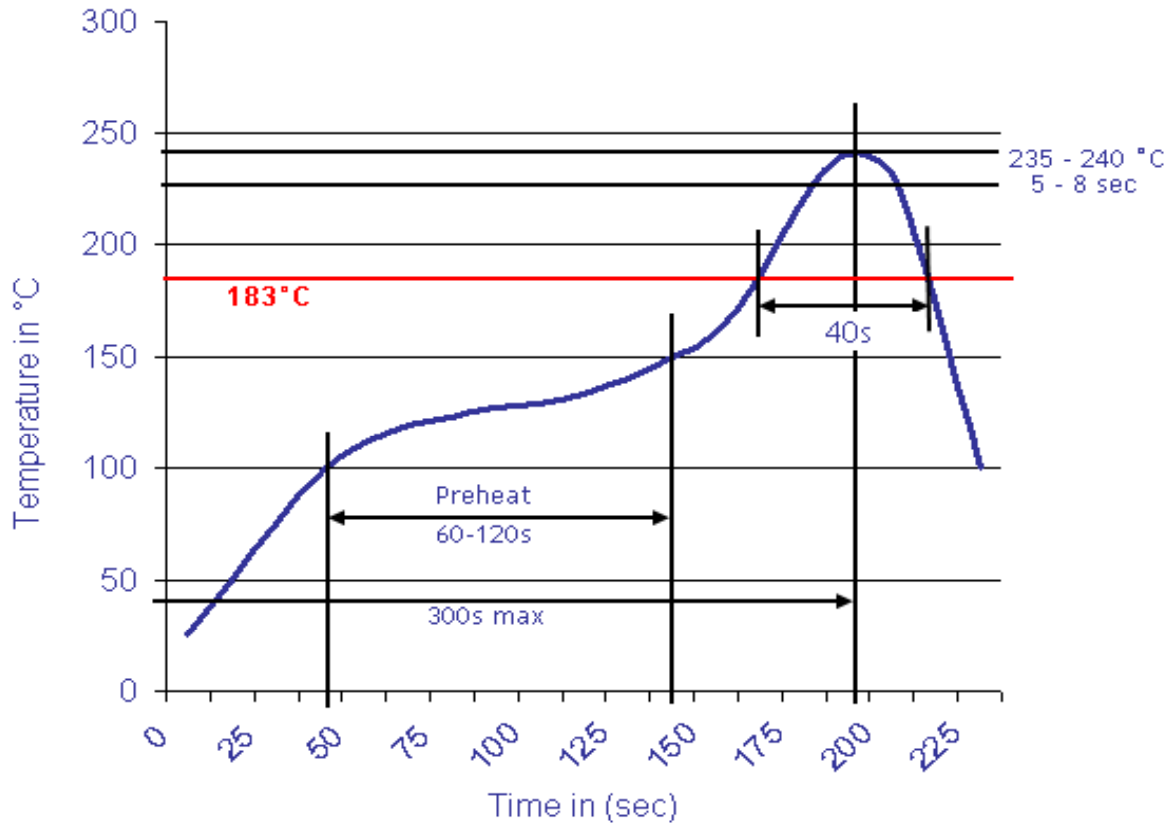

Pin Header for Pluggable Terminal Block 1,3/1,3mm	
Part No.:	A14L136
Customer:	

DRW:	Jason	CHKD	Wilson	MATL:	Wilson	TOLERANCE	Mason	DATE	06.02.2023
APPD:	Schumi			FINISH	Jamy		Sheet No.		4 from 4